



# INUMBRINA 38

© *design by dirk wynants*

---

## READ INSIDE

ASSEMBLY INSTRUCTIONS,  
HOW TO USE, USEFUL TIPS  
FOR KEEPING YOUR TOOL FOR  
TOGETHERNESS IN SHAPE

## LANGUAGES

EN – NL – DE – FR – IT – ES

## MORE

[WWW.EXTREMIS.COM](http://WWW.EXTREMIS.COM)

## PRODUCT

INUMBRINA – CONCRETE (WHEEL) BASE – FLOOR FASTENING –  
FIXATION INTO GARGANTUA / PANTAGRUËL – MAINTENANCE

## LANGUAGES

### ENGLISH

**P. 3**

contents .....	p. 3
assembly concrete base .....	p. 4
assembly concrete wheel base .....	p. 5
assembly directly to the floor .....	p. 6
open / close inumbrina .....	p. 6
assembly inumbrina into gargantua .....	p. 7
assembly inumbrina into pantagruel .....	p. 7
maintenance .....	p. 8

### NEDERLANDS

**P. 11**

inhoud .....	p. 11
montage sokkel in beton .....	p. 12
montage sokkel in beton op wielen .....	p. 13
montage grondverankering .....	p. 14
inumbrina openen / sluiten .....	p. 14
montage inumbrina in gargantua .....	p. 15
montage inumbrina in pantagruel .....	p. 15
onderhoud .....	p. 16

### DEUTSCH

**P. 19**

inhalt .....	p. 19
montage naturbetonständer .....	p. 20
montage naturbetonständer auf rollen .....	p. 21
montage bodenverankerung .....	p. 22
inumbrina öffnen / schließen .....	p. 22
montage inumbrina im gargantua .....	p. 23
montage inumbrina im pantagruel .....	p. 23
pflege .....	p. 24

### FRANÇAIS

**P. 27**

contenu .....	p. 27
montage socle en béton .....	p. 28
montage socle en béton sur roues .....	p. 29
montage fixation dans au sol .....	p. 30
ouvrier / fermer inumbrina .....	p. 30
montage inumbrina dans gargantua .....	p. 31
montage inumbrina dans pantagruel .....	p. 31
entretien .....	p. 32

### ITALIANO

**P. 35**

contenuto .....	p. 35
montaggio base di calcestruzzo .....	p. 36
montaggio base di calcestruzzo su ruote .....	p. 37
montaggio diretto al suolo .....	p. 38
apertura / chiusura inumbrina .....	p. 38
montaggio inumbrina con gargantua .....	p. 39
montaggio inumbrina con pantagruel .....	p. 39
manutenzione .....	p. 40

### ESPAÑOL

**P. 43**

contenido .....	p. 43
montaje base de hormigón .....	p. 44
montaje base de hormigón con ruedas .....	p. 45
montaje fijación directamente sobre el suelo .....	p. 46
abierto / cerca inumbrina .....	p. 46
montaje inumbrina con gargantua .....	p. 47
montaje inumbrina con pantagruel .....	p. 47
mantenimiento .....	p. 48

## CONTENTS

### INUMBRINA ON CONCRETE BASE

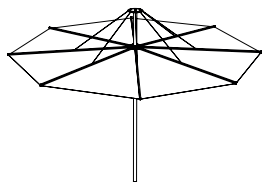

1 x inumbrina on tube

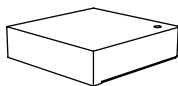

4 x concrete tile

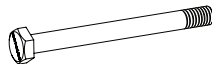

4 x bolt M10x110

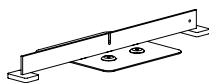

1 x frame A

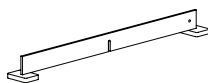

1 x frame B



4 x plastic glide

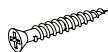

4 x screw M5x40



4 x plug

---

### INUMBRINA WITH ASSEMBLY DIRECTLY TO THE FLOOR

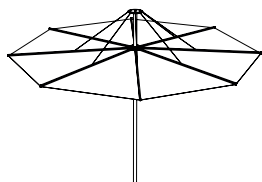

1 x inumbrina on tube

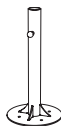

1 x extension tube

---

### INUMBRINA IN GARGANTUA / PANTAGRUËL

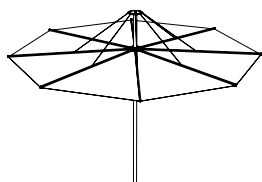

1 x inumbrina on tube



1 x assembly piece



4 x bolt M8x12



4 x lock washer

## ASSEMBLY INUMBRINA ON CONCRETE BASE

### WHAT YOU NEED



1 person



no. 17 spanner



screwdriver



+/- 30 min.

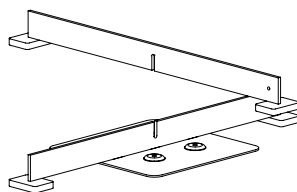

1. Position the first element of the cross-shaped base on the floor where you wish to place the parasol. Then slide the second element over first one ensuring that the grooves correspond and fit perfectly.

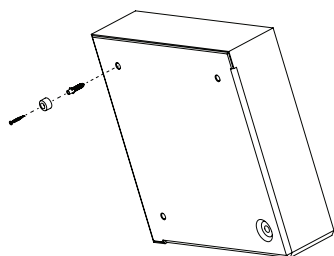

2. Fix the plastic glides to the bottom of the concrete tiles: put the supplied plugs into the holes and tighten the glides with the supplied screws.

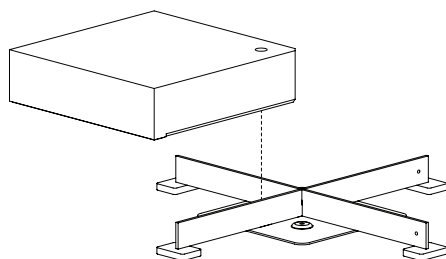

3. Put the four concrete tiles on top of the cross-shaped base. Align the holes in the concrete tiles with the holes in the metal plate of the cross-shaped base. The side with the bevelled corners should be facing downwards.

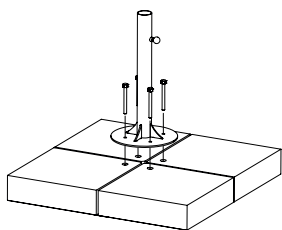

4. Position the stainless steel tube on top of the concrete tiles. Make sure that the holes in the stainless steel disk are perfectly aligned with the holes in the concrete tiles.

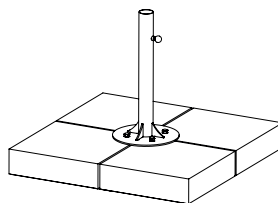

5. You can now attach the stainless steel tube to the concrete tiles using the four supplied bolts. Tighten them with a 17 mm openend wrench.

6. Insert the Inumbrina parasol in the anchor tube and fasten it by turning the adjusting screw clockwise. Always tighten the adjusting screw until the Inumbrina can no longer revolve on its axle.

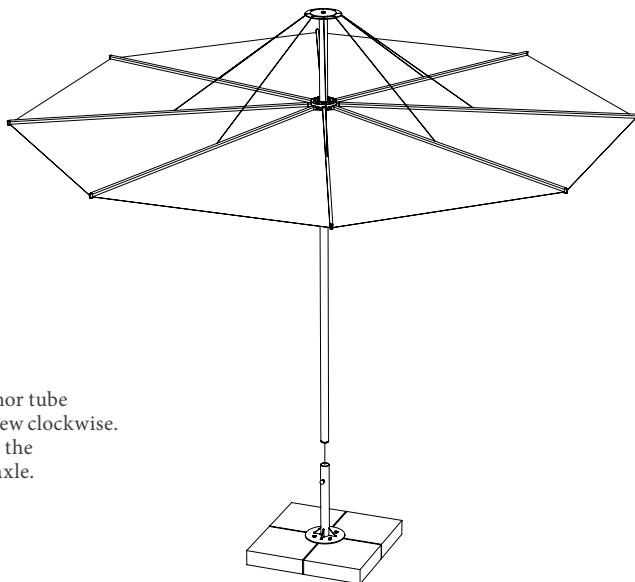

## ASSEMBLY CONCRETE WHEEL BASE

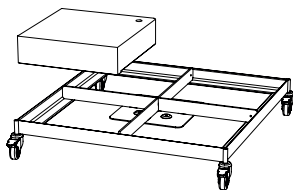

1. Put the four concrete tiles on top of the frame with wheels. Align the holes in the concrete tiles with the holes in the metal plate of the cross-shaped base. The side with the bevelled corners should be facing downwards.

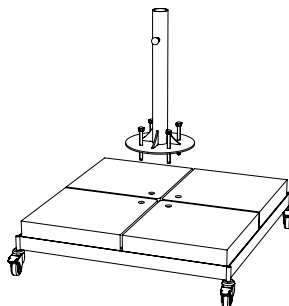

2. Position the stainless steel tube on top of the concrete tiles. Make sure that the holes in the stainless steel disk are perfectly aligned with the holes in the concrete tiles. You can now attach the stainless steel tube to the concrete tiles using the four supplied bolts. Tighten them with a 17 mm openend wrench

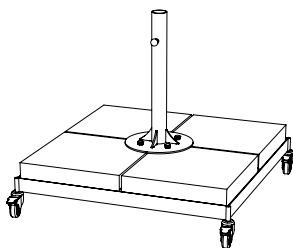

## ASSEMBLY INUMBRINA DIRECTLY TO THE FLOOR

### WHAT YOU NEED



1 person



+/- 30 min.

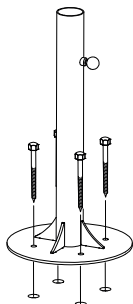

1. Position the stainless steel anchor tube where you want to install the parasol. Fix it tightly to the ground using anchor bolts (or other fixing mediums adapted to the surface in question).
2. Insert the Inumbrina parasol in the anchor tube and fasten it by turning the adjusting screw clockwise. Always tighten the adjusting screw until the Inumbrina can no longer revolve on its axle.

### USE

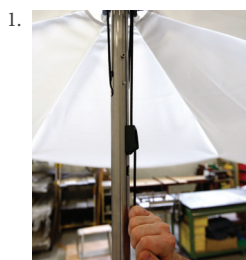

1. To open the parasol, firmly pull the rope until the parasol fabric is almost completely horizontal.

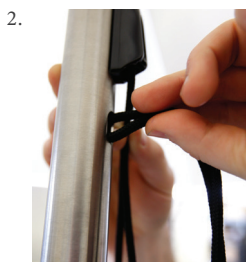

2. To put the rope in the tube, you should fold it in 2 and put the loop in the hole until it is completely tucked away.



To close the parasol again, take the rope out of the tube and hold it in a slight angle. **TIP:** keep the rope aslope until the parasol is completely closed.

## ASSEMBLY INUMBRINA INTO GARGANTUA

### WHAT YOU NEED



1 person



no. 5 hex key



+/- 20 min.

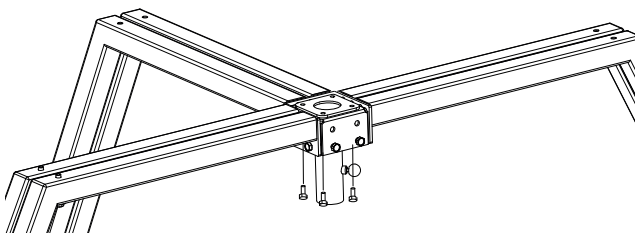

Fasten the attaching part to the central metal part connecting the 4 Gargantua legs, as shown in the drawing.

Now reassemble your Gargantua table. Insert the Inumbrina parasol in the Gargantua anchor tube and fasten it by turning the adjusting screw clockwise. Always tighten the adjusting screw until the Inumbrina can no longer revolve on its axle.

## ASSEMBLY INUMBRINA INTO PANTAGRUEL

### WHAT YOU NEED



1 person



no. 5 hex key



+/- 20 min.

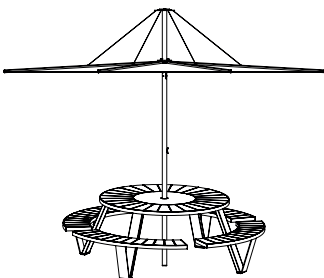

1. Remove the Lazy Susan.

2. Put the inumbrina38 insert in the hole in the middle of the tabletop. Make sure that the cylindrical part is facing downwards and the square plate is facing upwards.

3. Fasten the insert to the table, putting the bolts through the bottom of the table. Put the Lazy Susan back into its original position.

4. Put the inumbrina parasol in the Pantagruel table and block it by turning the adjusting screw clockwise. The adjusting screw is sufficiently tightened when the inumbrina parasol can no longer revolve on its axis.

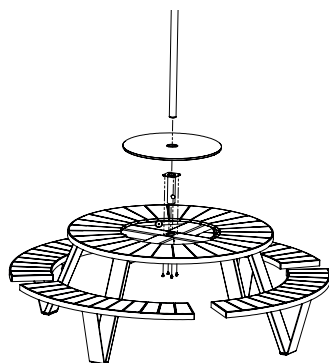

## MAINTENANCE

### FABRIC

Clean the fabric of the parasol and the slip over cover by rinsing it with water and hand soap, cleaning it with a soft brush. First and foremost beware that the parasol does not get dirty and use the slip over cover as much as possible.

We strongly advise you not to use a high-pressure hose.

Do not use any aggressive detergents, as they will remove the protective coating of the fabric.

### STAINLESS STEEL TUBE

Stainless steel is not sea water proof. Especially in an aggressive environment (maritime climate, chlorine, acid rain, aggressive industrial or urban environment) we recommend to frequently use surface cleansing, the adequate products necessary therefore are generally available.

### WARNING

In case of strong winds or when not in use, protect the Inumbrina with the (optional) parasol cover or store it indoors to avoid the parasol from blowing open or getting dirty.

Do not leave the parasol unattended when opened.

For ventilation purposes, the cover is not 100% water proof.

Do not leave closed if not completely dry. Do not leave the parasol closed for a long time if it is still damp or wet.

Store the parasol when not in use for a long time as follows: vertically, completely dry and in a dry environment.



[WWW.EXTREMIS.BE](http://WWW.EXTREMIS.BE)

## LANGUAGES

### ENGLISH

**P. 3**

contents .....	p. 3
assembly concrete base .....	p. 4
assembly concrete wheel base .....	p. 5
assembly directly to the floor .....	p. 6
open / close inumbrina .....	p. 6
assembly inumbrina into gargantua .....	p. 7
assembly inumbrina into pantagruel .....	p. 7
maintenance .....	p. 8

### NEDERLANDS

**P. 11**

inhoud .....	p. 11
montage sokkel in beton .....	p. 12
montage sokkel in beton op wielen .....	p. 13
montage grondverankering .....	p. 14
inumbrina openen / sluiten .....	p. 14
montage inumbrina in gargantua .....	p. 15
montage inumbrina in pantagruel .....	p. 15
onderhoud .....	p. 16

### DEUTSCH

**P. 19**

inhalt .....	p. 19
montage naturbetonständer .....	p. 20
montage naturbetonständer auf rollen .....	p. 21
montage bodenverankerung .....	p. 22
inumbrina öffnen / schließen .....	p. 22
montage inumbrina im gargantua .....	p. 23
montage inumbrina im pantagruel .....	p. 23
pflege .....	p. 24

### FRANÇAIS

**P. 27**

contenu .....	p. 27
montage socle en béton .....	p. 28
montage socle en béton sur roues .....	p. 29
montage fixation dans au sol .....	p. 30
ouvrier / fermer inumbrina .....	p. 30
montage inumbrina dans gargantua .....	p. 31
montage inumbrina dans pantagruel .....	p. 31
entretien .....	p. 32

### ITALIANO

**P. 35**

contenuto .....	p. 35
montaggio base di calcestruzzo .....	p. 36
montaggio base di calcestruzzo su ruote .....	p. 37
montaggio diretto al suolo .....	p. 38
apertura / chiusura inumbrina .....	p. 38
montaggio inumbrina con gargantua .....	p. 39
montaggio inumbrina con pantagruel .....	p. 39
manutenzione .....	p. 40

### ESPAÑOL

**P. 43**

contenido .....	p. 43
montaje base de hormigón .....	p. 44
montaje base de hormigón con ruedas .....	p. 45
montaje fijación directamente sobre el suelo .....	p. 46
abierto / cerca inumbrina .....	p. 46
montaje inumbrina con gargantua .....	p. 47
montaje inumbrina con pantagruel .....	p. 47
mantenimiento .....	p. 48

## INHOUD

### INUMBRINA OP SOKKEL IN BETON

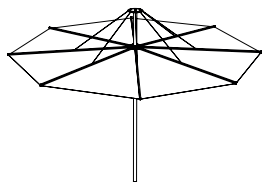

1 x inumbrina op paal



4 x betonblok

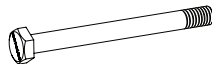

4 x bout M10x110

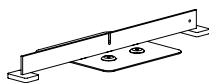

1 x frame A

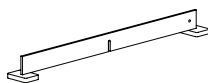

1 x frame B



4 x dopje

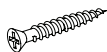

4 x schroef M5x40



4 x plug

---

### INUMBRINA MET GRONDVERANKERING

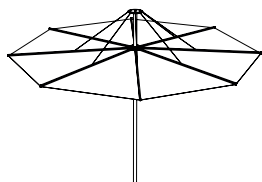

1 x inumbrina op paal

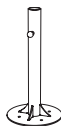

1 x verlengpaal grondverankering

---

### INUMBRINA IN GARGANTUA / PANTAGRUËL

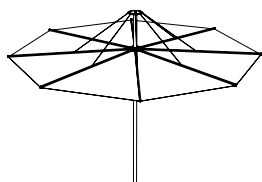

1 x inumbrina op paal



1 x bevestigingsstuk



4 x bout M8x12



4 x veerring

# MONTAGE INUMBRINA OP SOKKEL IN BETON

## BENODIGDHEDEN



1 persoon



steeksleutel nr. 17



philips schroevendraaier



+/- 30 min.

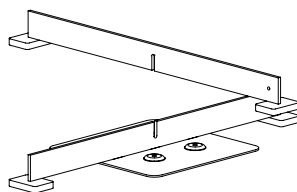

1. Plaats het eerste stuk op de grond, daar waar u de parasol wil opstellen. Schuif vervolgens het tweede stuk er over, zodat de sleuven in elkaar passen.

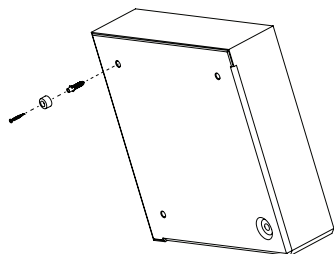

2. Bevestig de plastic dopjes onderaan de betonblokken: plaats bijgeleverde plug in het blindgat en bevestig dan de dop door middel van bijgeleverde schroef.

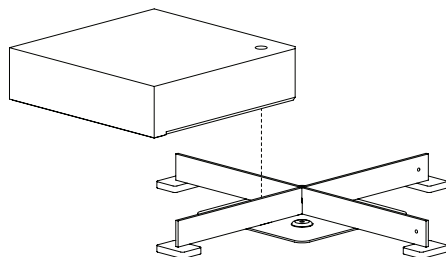

3. Plaats nu de 4 betonblokken op het positioneringskruis. Zorg ervoor dat de openingen in de betonblokken steeds boven de openingen in de onderplaat van het positioneringskruis passen. De kant waar de randen afgeschuind zijn, is de onderkant.

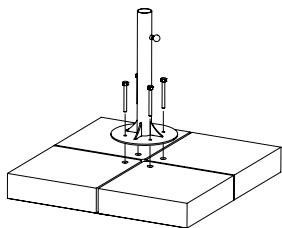

4. Plaats nu de rvs buis op de betonblokken en zorg ervoor dat de gaten in de rvs schijf mooi over de gaten van de betonblokken passen.

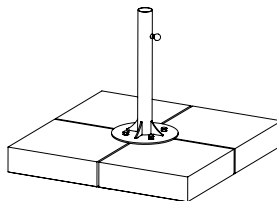

5. De rvs buis kan nu vastgemaakt worden d.m.v. de 4 bijgeleverde bouten. Span deze aan met een steeksleutel van 17.

6. Plaats vervolgens de Inumbrina parasol in de basis, en vergendel door de stelschroef in wijzerzin te draaien. Pas als de Inumbrina niet meer rond haar as kan bewegen, is de stelschroef voldoende vastgeklemd.

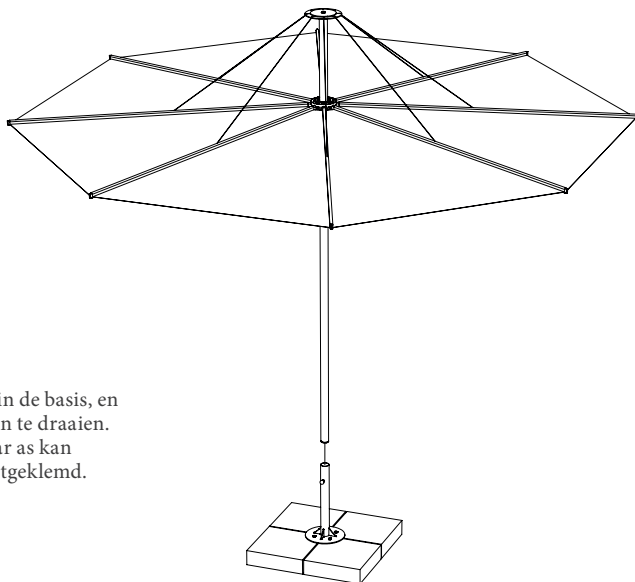

## SOKKEL IN BETON OP WIELEN

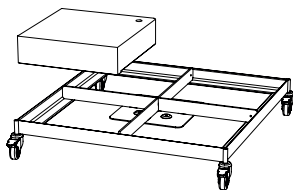

1. Plaats de de 4 betonblokken op het frame met wielen. Zorg ervoor dat de openingen in de betonblokken steeds boven de openingen in de onderplaat van het positioneringskruis passen. De kant waar de randen afgeschuind zijn, is de onderkant.

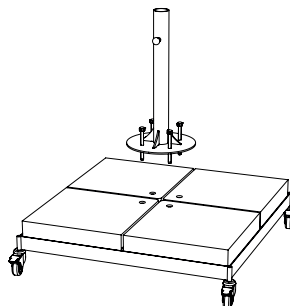

2. Plaats nu de rvs buis op de betonblokken en zorg ervoor dat de gaten in de rvs schijf mooi over de gaten van de betonblokken passen. Plaats het vlakke gedeelte van de kone daar waar u de hendel wil. De rvs buis kan nu vastgemaakt worden d.m.v. de 4 bijgeleverde bouten. Span deze aan met een steeksleutel van 17.

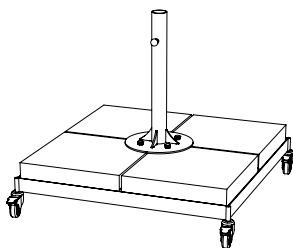

## MONTAGE INUMBRINA MET GRONDVERANKERING

### BENODIGDHEDEN



1 persoon



+/- 30 min.

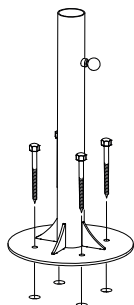

1. Plaats de rvs onderbuis op de plaats waar u de parasol wil opstellen en maak deze stevig vast aan de ondergrond d.m.v. ankerbouten (of de bevestigingsmiddelen die best geschikt zijn voor uw ondergrond).
2. Plaats vervolgens de Inumbrina parasol in de basis, en vergendel door de stelschroef in wijzerzin te draaien. Pas als de Inumbrina niet meer rond haar as kan bewegen, is de stelschroef voldoende vastgeklemd.

### GEBRUIK

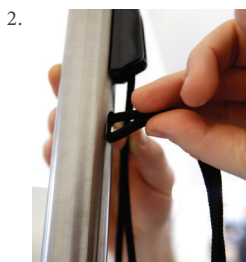
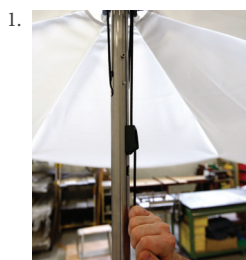

1. Om de parasol te openen, trek je stevig aan het touw, totdat de krans tegen het boutje komt.
2. Om het touw in de buis te stoppen, vouwt men deze in 2 en stopt men de lus in het gaatje tot deze volledig weg zit.



Om de parasol terug te sluiten haal je het touw uit de buis en hou je deze wat schuin. **TIP:** blijf het touw schuin vasthouden tot de parasol volledig gesloten is.

## MONTAGE INUMBRINA IN GARGANTUA

### BENODIGDHEDEN



1 persoon



inbussleutel nr. 5



+/- 20 min.

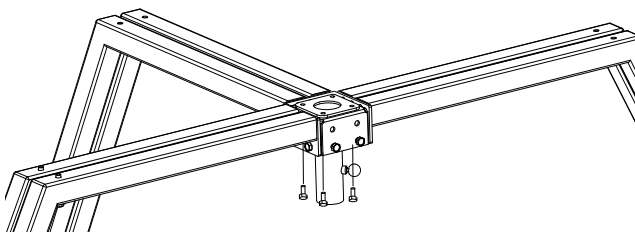

Plaats het bevestigingsstuk op het centrale metalen stuk dat de 4 Gargantua poten met elkaar verbindt, zoals te zien op de tekening.

Monteer hierna opnieuw uw Gargantua tafel. Plaats vervolgens de Inumbrina parasol in de Gargantua, en vergrendel door de stelschroef in wijzerzin te draaien. Pas als de Inumbrina niet meer rond haar as kan bewegen, is de stelschroef voldoende vastgeklemd.

## MONTAGE INUMBRINA IN PANTAGRUEL

### BENODIGDHEDEN



1 persoon



inbussleutel nr. 5



+/- 20 min.

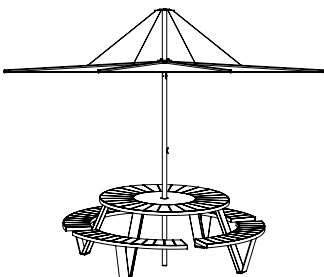

1. Verwijder de lazy susan.

2. Plaats het Inumbrina 38 bevestigingsstuk in de middelste opening van het tafelblad. Doe dit met de cilinder naar beneden en met het vierkant plaat naar boven gericht.

3. Bout dit stuk vervolgens vast aan de tafel, door de bouten onderaan door de tafel te steken. Leg nu de lazy susan terug op zijn plaats in de tafel.

4. Plaats nu de Inumbrina in de Pantagruel tafel, en vergrendel door de stelschroef in wijzerzin aan te draaien. Pas als de Inumbrina niet meer rond haar as kan bewegen, is de stelschroef voldoende vastgeklemd.

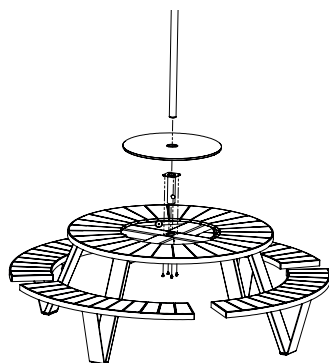

## ONDERHOUD

### PARASOL STOF

Reinig het zeil van de parasol en de hoes door te spoelen met water en handzeep, en voorzichtig te wrijven met een zachte borstel. Zorg er in eerste instantie voor dat de parasol stof niet te vuil wordt en plaats zo veel mogelijk de hoes over de parasol.

Spuit de parasol nooit af met een hoge drukreiniger.

Gebruik geen detergents. Deze tasten de beschermlaag van het textiel aan.

### ROESTVAST STAAL

Roestvast staal is niet zeewaterbestendig. Vooral in een agressieve omgeving (maritiem klimaat, chloor, zure regen, agressieve industriële of stedelijke omgeving) raden wij aan om regelmatig het oppervlak te reinigen. De geschikte producten voor het reinigen van roestvrij staal zijn in de handel te koop.

### WAARSCHUWING

Bij niet-gebruik of hevige wind, breng de hoes (optioneel)aan of haal de Inumbrina binnenshuis om te vermijden dat de parasol open waait of vuil wordt.

Laat de geopende parasol nooit onbewaakt achter.

Om ventilatie redenen is de hoes niet 100% waterdicht.

Laat Inumbrina niet gesloten als ze niet volledig droog is. Laat ze niet gedurende lange tijd gesloten in vochtige omstandigheden.

Als u de parasol voor lange tijd niet gebruikt, berg ze dan op als volgt: vertikaal, perfect gedroogd in een droge omgeving.



[WWW.EXTREMIS.BE](http://WWW.EXTREMIS.BE)

## LANGUAGES

### ENGLISH

**P. 3**

contents .....	p. 3
assembly concrete base .....	p. 4
assembly concrete wheel base .....	p. 5
assembly directly to the floor .....	p. 6
open / close inumbrina .....	p. 6
assembly inumbrina into gargantua .....	p. 7
assembly inumbrina into pantagruel .....	p. 7
maintenance .....	p. 8

### NEDERLANDS

**P. 11**

inhoud .....	p. 11
montage sokkel in beton .....	p. 12
montage sokkel in beton op wielen .....	p. 13
montage grondverankering .....	p. 14
inumbrina openen / sluiten .....	p. 14
montage inumbrina in gargantua .....	p. 15
montage inumbrina in pantagruel .....	p. 15
onderhoud .....	p. 16

### DEUTSCH

**P. 19**

inhalt .....	p. 19
montage naturbetonständer .....	p. 20
montage naturbetonständer auf rollen .....	p. 21
montage bodenverankerung .....	p. 22
inumbrina öffnen / schließen .....	p. 22
montage inumbrina im gargantua .....	p. 23
montage inumbrina im pantagruel .....	p. 23
pflege .....	p. 24

### FRANÇAIS

**P. 27**

contenu .....	p. 27
montage socle en béton .....	p. 28
montage socle en béton sur roues .....	p. 29
montage fixation dans au sol .....	p. 30
ouvrier / fermer inumbrina .....	p. 30
montage inumbrina dans gargantua .....	p. 31
montage inumbrina dans pantagruel .....	p. 31
entretien .....	p. 32

### ITALIANO

**P. 35**

contenuto .....	p. 35
montaggio base di calcestruzzo .....	p. 36
montaggio base di calcestruzzo su ruote .....	p. 37
montaggio diretto al suolo .....	p. 38
apertura / chiusura inumbrina .....	p. 38
montaggio inumbrina con gargantua .....	p. 39
montaggio inumbrina con pantagruel .....	p. 39
manutenzione .....	p. 40

### ESPAÑOL

**P. 43**

contenido .....	p. 43
montaje base de hormigón .....	p. 44
montaje base de hormigón con ruedas .....	p. 45
montaje fijación directamente sobre el suelo .....	p. 46
abierto / cerca inumbrina .....	p. 46
montaje inumbrina con gargantua .....	p. 47
montaje inumbrina con pantagruel .....	p. 47
mantenimiento .....	p. 48

# INHALT

## INUMBRINA IN BETONSOCKEL

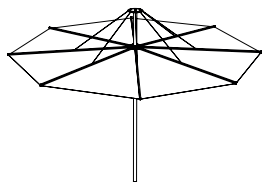

1 x inumbria und rohr



4 x Betonblöcke

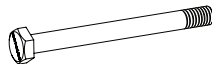

4 x Schrauben M10x110

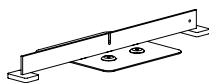

1 x Gestell A

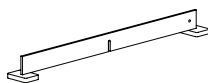

1 x Gestell B



4 x Kunststoffmutter

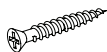

4 x Schraube M5x40



4 x Dübel

---

## INUMBRA MIT BODENVERANKERUNG

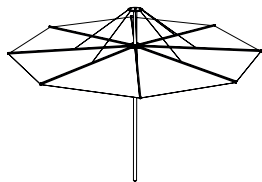

1 x inumbria und rohr

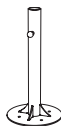

1 x ausdehnung verankerung

---

## INUMBRINA IN GARGANTUA / PANTAGRUËL

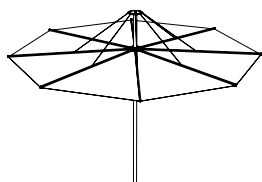

1 x inumbria und rohr



1 x fixierung



4 x Schraube M8x12



4 x Sprengring

# MONTAGE INUMBRINA IN NATURBETONSTÄNDER

## WAS SIE BRAUCHEN



1 Person



Maulschlüssel Nr. 17



Schraubenzieher



+/- 30 min.

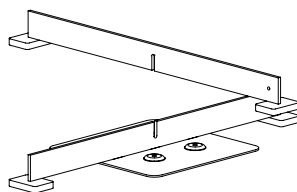

1. Stellen Sie den ersten Teil des Positionierungskreuzes an die Stelle, an der Sie den Sonnenschirm aufstellen möchten. Schieben Sie anschließend den zweiten Teil über den ersten, so dass die Rillen ineinander passen.

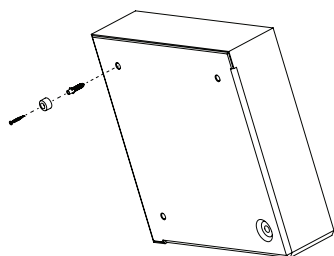

2. Montieren der Kunststoffmutter an der Betonblockunterseite: Stecken Sie den mitgelieferten Dübel in das Blindloch, und befestigen Sie die Mutter mit der mitgelieferten Schraube.

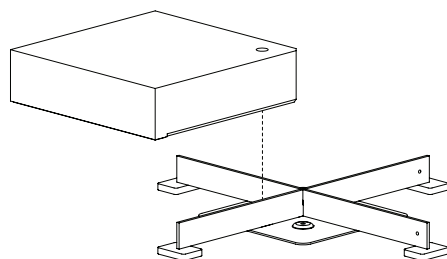

3. Stellen Sie die 4 Betonblöcke auf das Positionierungskreuz. Achten Sie darauf, dass die Betonblocköffnungen sich immer über den Öffnungen in der unteren Platte des Positionierungskreuzes befinden. Die Seite mit den abgeschrägten Ecken ist die Unterseite.

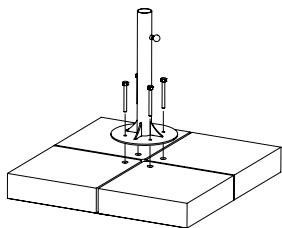

4. Stellen Sie das Edelstahlrohr auf die Betonblöcke und achten Sie darauf, dass die Löcher des Edelstahlrohrs sich genau über denen der Betonblöcke befinden.

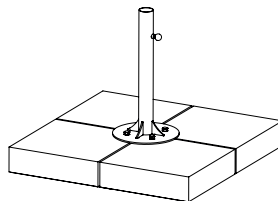

5. Das Edelstahlrohr kann mit den 4 mitgelieferten Bolzen befestigt werden. Ziehen Sie sie mit einem Gabelschlüssel 17 fest an.

6. Stecken Sie danach den Inumbrina in die Basis. Zum Verriegeln drehen Sie die Stellschraube im Uhrzeigersinn. Erst wenn der Inumbrina sich nicht mehr um seine Achse drehen kann, ist die Stellschraube ausreichend angezogen vastgeklemd.

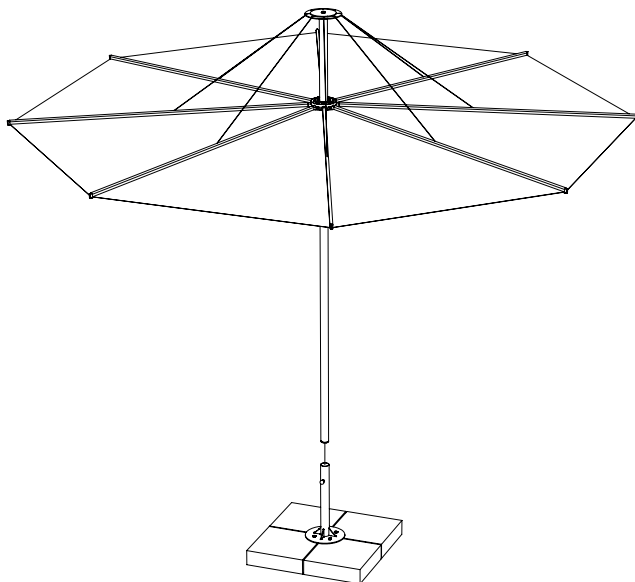

## MONTAGE NATURBETONSTÄNDER AUF ROLLEN

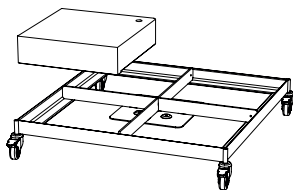

1. Stellen Sie die 4 Betonblöcke auf das Positionierungskreuz. Achten Sie darauf, dass die Betonblocköffnungen sich immer über den Öffnungen in der unteren Platte des Positionierungskreuzes befinden. Die Seite mit den abgeschrägten Ecken ist die Unterseite.

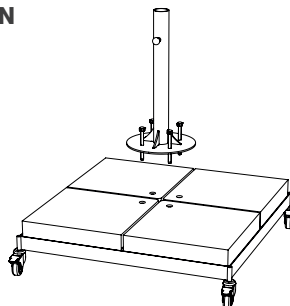

2. Stellen Sie das Edelstahlrohr auf die Betonblöcke und achten Sie darauf, dass die Löcher des Edelstahlrohrs sich genau über denen der Betonblöcke befinden. Das Edelstahlrohr kann mit den 4 mitgelieferten Bolzen befestigt werden. Ziehen Sie sie mit einem Gabelschlüssel 17 fest an

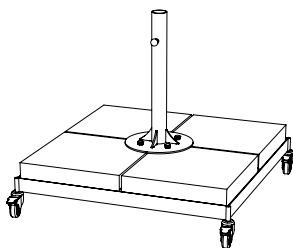

## MONTAGE INUMBRINA MIT BODENVERANKERUNG

### WAS SIE BRAUCHEN



1 Person



+/- 30 min.

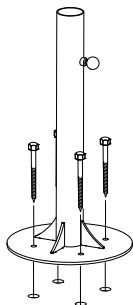

1. Setzen Sie die Edelstahlbodenhülse an der Stelle ein, wo Sie den Sonnenschirm aufstellen wollen. Befestigen Sie sie mit Verankerungsschrauben (oder den Befestigungsmitteln, die für Ihren Boden am besten geeignet sind) im Boden.
2. Stecken Sie danach den Inumbrina in die Basis. Zum Verriegeln drehen Sie die Stellschraube im Uhrzeigersinn. Erst wenn der Inumbrina sich nicht mehr um seine Achse drehen kann, ist die Stellschraube ausreichend angezogen.

### GEBRAUCH

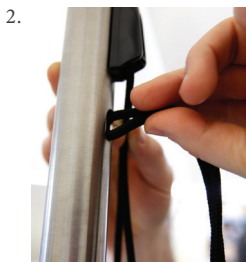
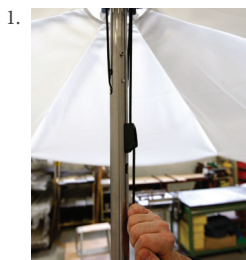

1. Zum Öffnen des Sonnenschirms ziehen Sie kräftig am Seil, bis die Schirmfläche beinahe vollkommen waagrecht ist.
2. Um das Seil in das Rohr zu verstecken, falten Sie das Seil in 2 und stecken Sie die Schleife in das Loch bis es ganz verschwunden ist.

Wenn Sie den Sonnenschirm schließen wünschen, nehmen Sie das Seil aus dem Rohr und neigen Sie es ein bisschen. **HINWEIS:** neigen Sie das Seil bis den Sonnenschirm ganz geschlossen ist.

## MONTAGE INUMBRINA IM GARGANTUA

### WAS SIE BRAUCHEN



1 Person



inbusschlüssel Nr. 5



+/- 20 min.

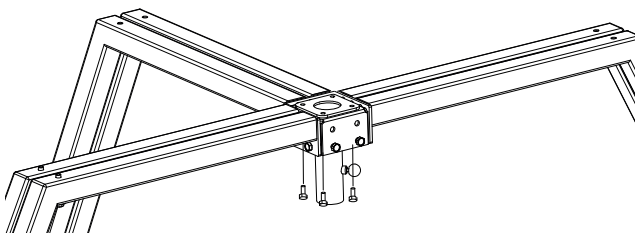

Montieren Sie die Befestigung auf das mittige Metallteil, das die 4 Gargantua-Beine miteinander verbindet, wie auf Zeichnung zu sehen.

Bauen Sie Ihren Gargantua-Tisch danach wieder zusammen. Stecken Sie danach den Inumbrina in die Basis. Zum verriegeln drehen Sie die Stellschraube im Uhrzeigersinn. Erst wenn der Inumbrina sich nicht mehr um seine Achse drehen kann, ist die Stellschraube ausreichend angezogen vastgeklemd.

## MONTAGE INUMBRINA IM PANTAGRUEL

### WAS SIE BRAUCHEN



1 Person



inbusschlüssel Nr. 5



+/- 20 min.

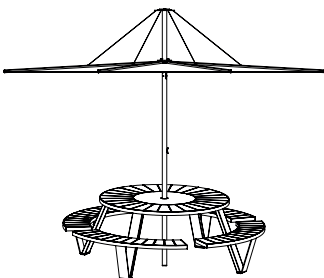

1. Entfernen Sie die Lazy Susan.
2. Setzen Sie das Inumbrina-38-Befestigungsstück in die mittige Öffnung der Tischplatte ein. Achten Sie darauf, dass der Zylinder nach unten und die quadratische Platte nach oben weisen.

3. Schrauben Sie dieses Teil dann am Tisch fest, indem Sie die Schrauben unten durch den Tisch stecken. Setzen Sie die Inumbrina jetzt an ihrem Platz im Tisch ein.
4. Stecken Sie danach den Inumbrina in die Basis. Zum verriegeln drehen Sie die Stellschraube im Uhrzeigersinn. Erst wenn der Inumbrina sich nicht mehr um seine Achse drehen kann, ist die Stellschraube ausreichend angezogen vastgeklemd.

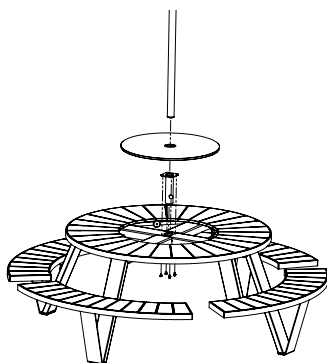

## PFLEGE

### STOFF

Reinigen Sie den Stoff des Sonnenschirms und den Bezug, indem Sie diese mit Wasser und Seife abspülen und vorsichtig mit einer weichen Bürste abreiben. Achten Sie darauf, dass der Sonnenschirmstoff nicht zu schmutzig wird, und ziehen Sie so oft wie möglich den Bezug über den Sonnenschirm.

Spritzen Sie den Sonnenschirm nie mit einem Hochdruckreiniger ab.

Verwenden Sie keine Reinigungsmittel. Diese greifen die Schutzschicht des Stoffs an

### EDELSTAHL ROHR

Edelstahl ist nicht beständig gegen Meerwasser. Insbesondere in einer aggressiven Umgebung (Meeresklima, Chlor, saurer Regen, aggressives industrielles oder städtisches Umfeld) raten wir dazu, die Oberfläche häufig zu reinigen. Geeignete Reinigungsprodukte für Edelstahl finden Sie im Handel.

### WARNUNG

Bei Nichtgebrauch oder starkem Wind ziehen Sie die Hülle (Option) darüber oder holen Sie den Inumbrina ins Haus, um zu vermeiden, dass er sich öffnet oder verschmutzt.

Lassen Sie den geöffneten Sonnenschirm nie unbeaufsichtigt.

Aus Gründen der Belüftung ist die Hülle nicht 100% wasserdicht.

Lassen Sie Inumbrina nicht geschlossen, wenn er nicht vollkommen trocken ist. Lassen Sie ihn bei feuchten Bedingungen nicht für eine längere Zeit geschlossen.

Wenn Sie den Sonnenschirm eine längere Zeit nicht verwenden, bewahren Sie ihn senkrecht und vollkommen getrocknet in einer trockenen Umgebung auf.



[WWW.EXTREMIS.BE](http://WWW.EXTREMIS.BE)

## LANGUAGES

### ENGLISH

**P. 3**

contents .....	p. 3
assembly concrete base .....	p. 4
assembly concrete wheel base .....	p. 5
assembly directly to the floor .....	p. 6
open / close inumbrina .....	p. 6
assembly inumbrina into gargantua .....	p. 7
assembly inumbrina into pantagruel .....	p. 7
maintenance .....	p. 8

### NEDERLANDS

**P. 11**

inhoud .....	p. 11
montage sokkel in beton .....	p. 12
montage sokkel in beton op wielen .....	p. 13
montage grondverankering .....	p. 14
inumbrina openen / sluiten .....	p. 14
montage inumbrina in gargantua .....	p. 15
montage inumbrina in pantagruel .....	p. 15
onderhoud .....	p. 16

### DEUTSCH

**P. 19**

inhalt .....	p. 19
montage naturbetonständer .....	p. 20
montage naturbetonständer auf rollen .....	p. 21
montage bodenverankerung .....	p. 22
inumbrina öffnen / schließen .....	p. 22
montage inumbrina im gargantua .....	p. 23
montage inumbrina im pantagruel .....	p. 23
pflege .....	p. 24

### FRANÇAIS

**P. 27**

contenu .....	p. 27
montage socle en béton .....	p. 28
montage socle en béton sur roues .....	p. 29
montage fixation dans au sol .....	p. 30
ouvrier / fermer inumbrina .....	p. 30
montage inumbrina dans gargantua .....	p. 31
montage inumbrina dans pantagruel .....	p. 31
entretien .....	p. 32

### ITALIANO

**P. 35**

contenuto .....	p. 35
montaggio base di calcestruzzo .....	p. 36
montaggio base di calcestruzzo su ruote .....	p. 37
montaggio diretto al suolo .....	p. 38
apertura / chiusura inumbrina .....	p. 38
montaggio inumbrina con gargantua .....	p. 39
montaggio inumbrina con pantagruel .....	p. 39
manutenzione .....	p. 40

### ESPAÑOL

**P. 43**

contenido .....	p. 43
montaje base de hormigón .....	p. 44
montaje base de hormigón con ruedas .....	p. 45
montaje fijación directamente sobre el suelo .....	p. 46
abierto / cerca inumbrina .....	p. 46
montaje inumbrina con gargantua .....	p. 47
montaje inumbrina con pantagruel .....	p. 47
mantenimiento .....	p. 48

## CONTENU

### INUMBRINA SUR SOCLE EN BÉTON

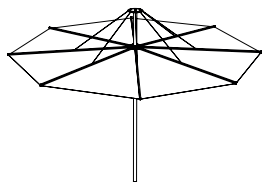

1 x inumbrina et tube

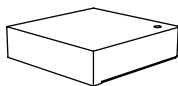

4 x bloc en béton

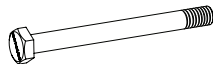

4 x boulon M10x110

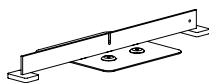

1 x support A

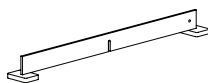

1 x support B



4 x capouchon en plastique

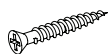

4 x boulon M5x40



4 x cheville

---

### INUMBRINA AVEC FIXATION DIRECT AU SOL

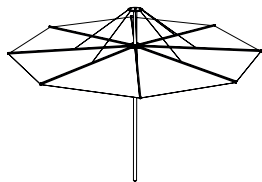

1 x inumbrina et tube

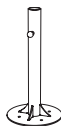

1 x tube de rallonge

---

### INUMBRINA IN GARGANTUA / PANTAGRUËL

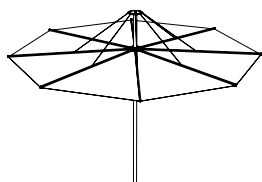

1 x inumbrina et tube



1 x fixation



4 x boulon M8x12



4 x rondelle élastique

# MONTAGE INUMBRINA SUR SOCLE EN BÉTON

## OUTILS



1 personne



clé plate n° 17



tournevis



+/- 30 min.

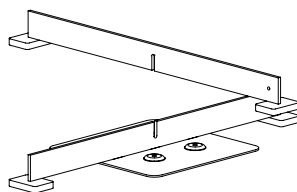

1. Placez le premier élément du pied en forme de croix sur le sol, à l'endroit où vous voulez installer le parasol. Glissez ensuite le deuxième élément sur le premier, de manière à ce que les fentes s'emboîtent.

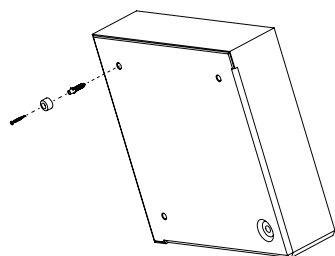

2. Fixez les capuchons en plastique sous les blocs de béton: insérez les chevilles fournies dans les trous borgnes et fixez ensuite les capuchons au moyen des vis fournies.

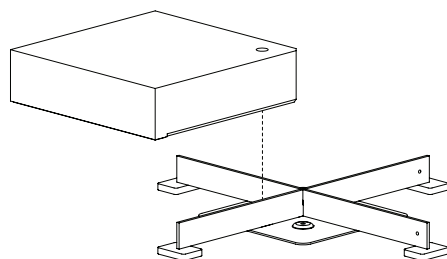

3. Posez à présent les 4 blocs en béton sur le pied en croix. Veillez à ce que les orifices dans les blocs en béton correspondent aux trous dans la plaque inférieure de la croix. Le côté dont les bords sont biseautés est le bas.

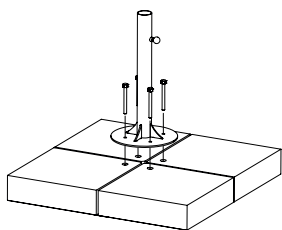

4. Placez à présent le tube en inox sur les blocs en béton en alignant bien les trous dans le disque au bas du tube en inox avec les trous dans les blocs en béton.

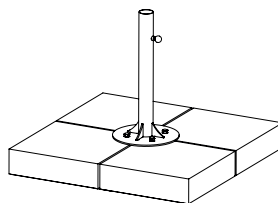

5. Le tube en inox peut à présent être fixé au moyen des 4 boulons fournis. Serrez les boulons au moyen d'une clé plate n° 17.

6. Insérez ensuite le parasol Inumbrina, et fixez-le en tournant la vis de réglage dans le sens des aiguilles d'une montre. Il faut que le parasol ne puisse plus tourner sur son axe. Sinon, c'est que la vis n'est pas suffisamment serrée.

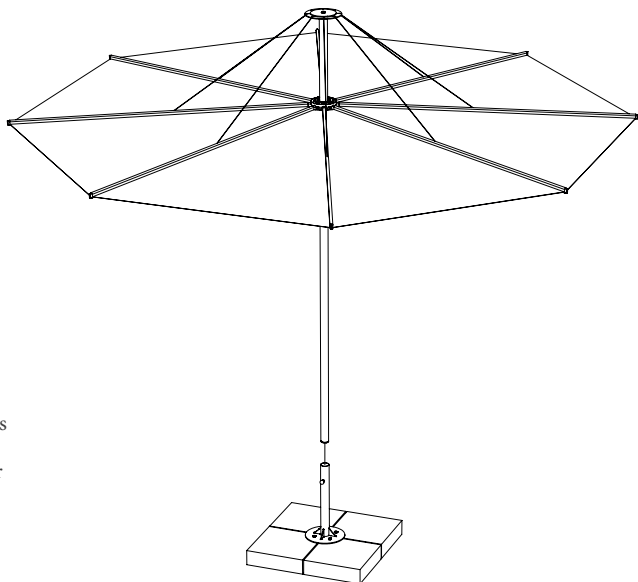

## MONTAGE BASE EN BÉTON SUR ROUES

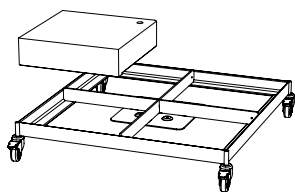

1. Posez à présent les 4 blocs en béton sur le pied en croix. Veillez à ce que les orifices dans les blocs en béton correspondent aux trous dans la plaque inférieure de la croix. Le côté dont les bords sont biseautés est le bas.

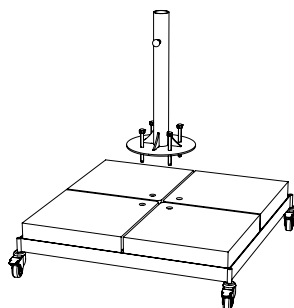

2. Placez à présent le tube en inox sur les blocs en béton en alignant bien les trous dans le disque au bas du tube en inox avec les trous dans les blocs en béton. Le tube en inox peut à présent être fixé au moyen des 4 boulons fournis. Serrez les boulons au moyen d'une clé plate n° 17.

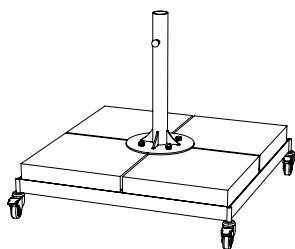

# MONTAGE INUMBRINA SUR SOCLE EN BÉTON

## OUTILS



1 personne



+/- 30 min.

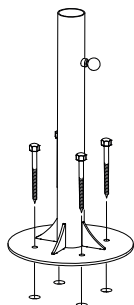

1. Placez le tube inférieur en inox à l'endroit où vous souhaitez installer le parasol, et fixez-le solidement dans le sol au moyen de boulons de fondation (ou au moyen de fixations adaptées au sol en questions).
2. Insérez ensuite le parasol Inumbrina, et fixez-le en tournant la vis de réglage dans le sens des aiguilles d'une montre. Il faut que le parasol ne puisse plus tourner sur son axe. Sinon, c'est que la vis n'est pas suffisamment serrée.

## UTILISATION

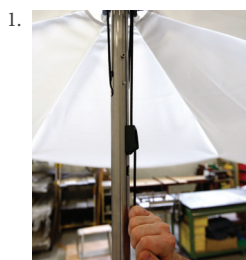

1. Pour ouvrir le parasol, tirez fermement sur la corde jusqu'à ce que la toile soit presque tout à fait à l'horizontale.

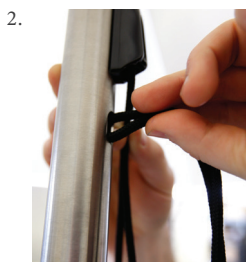

2. Vous pouvez mettre la corde dans le tube si vous pliez la corde en 2 et mettez la boucle dans le trou jusqu'à ce qu'elle soit complètement cachée.



Si vous voulez fermer le parasol, prenez la corde du tube et tenez-la légèrement inclinée. **CONSEIL:** tenez la corde inclinée jusqu'à ce que le parasol soit complètement fermé.

## MONTAGE INUMBRINA DANS GARGANTUA

### OUTILS



1 personne



clé Allen n° 5



+/- 20 min.

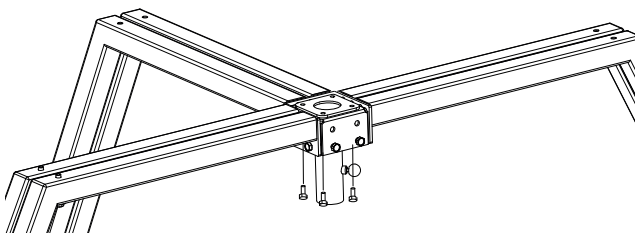

Placez la pièce de fixation sur la pièce métallique centrale que relie les 4 pieds de la table Gargantua, comme illustré dans l'illustration.

Remontez ensuite votre table Gargantua. Insérez ensuite le parasol Inumbrina, et fixez-le en tournant la vis de réglage dans le sens des aiguilles d'une montre. Il faut que le parasol ne puisse plus tourner sur son axe. Sinon, c'est que la vis n'est pas suffisamment serrée.

## MONTAGE INUMBRINA DANS PANTAGRUEL

### OUTILS



1 personne



clé Allen n° 5



+/- 20 min.

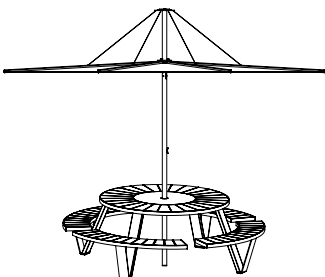

1. Retirer le Lazy Susan.
2. Placez la pièce de fixation Inumbrina 38 dans l'orifice au centre du plateau de table, avec le côté cylindrique orienté vers le bas et le côté carré orienté vers le haut.

3. Fixez ensuite cette pièce à la table en insérant les boulons par le dessous à travers la table. Reposez à présent le lazy susan dans la table.

4. Insérez ensuite le parasol Inumbrina, et fixez-le en tournant la vis de réglage dans le sens des aiguilles d'une montre. Il faut que le parasol ne puisse plus tourner sur son axe. Sinon, c'est que la vis n'est pas suffisamment serrée.

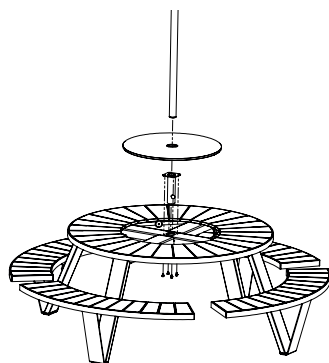

## ENTRETIEN

### LA TOILE

Pour nettoyer la toile du parasol et la housse, utilisez de l'eau et du savon pour les mains et frottez délicatement avec une brosse douce. Veillez à ce que le tissu du parasol ne se salisse pas exagérément, et replacez systématiquement la housse sur le parasol.

Ne lavez jamais le parasol avec un nettoyeur haute pression.

N'utilisez pas de détergents. Ceux-ci endommagent la couche de protection du textile.

### ACIER INOXYDABLE

L'acier inoxydable ne résiste pas à l'eau de mer. Surtout dans un environnement agressif (climat marin, chlore, pluie acide, environnement industriel ou urbain agressif) nous recommandons de nettoyer fréquemment la surface. Les produits appropriés pour nettoyer l'acier inoxydable sont en vente dans le commerce.

### AVERTISSEMENT

Lorsque vous n'utilisez pas le parasol ou par grand vent, placez la housse (en option) sur le parasol ou rentrez le parasol Inumbrina pour éviter qu'il ne s'ouvre ou ne se salisse.

Ne laissez jamais le parasol ouvert sans surveillance.

Pour des raisons de ventilation, la housse n'est pas imperméable à 100%.

Ne laissez pas Inumbrina en position fermée si la toile n'est pas tout à fait sèche. Ne laissez pas le parasol fermé pendant une longue période dans un environnement humide. Si vous utilisez pas le parasol pendant une période prolongée, rangez-le de la manière suivante: en position verticale, parfaitement sec et dans un environnement sec.



[WWW.EXTREMIS.BE](http://WWW.EXTREMIS.BE)

## LANGUAGES

### ENGLISH

**P. 3**

contents .....	p. 3
assembly concrete base .....	p. 4
assembly concrete wheel base .....	p. 5
assembly directly to the floor .....	p. 6
open / close inumbrina .....	p. 6
assembly inumbrina into gargantua .....	p. 7
assembly inumbrina into pantagruel .....	p. 7
maintenance .....	p. 8

### NEDERLANDS

**P. 11**

inhoud .....	p. 11
montage sokkel in beton .....	p. 12
montage sokkel in beton op wielen .....	p. 13
montage grondverankering .....	p. 14
inumbrina openen / sluiten .....	p. 14
montage inumbrina in gargantua .....	p. 15
montage inumbrina in pantagruel .....	p. 15
onderhoud .....	p. 16

### DEUTSCH

**P. 19**

inhalt .....	p. 19
montage naturbetonständer .....	p. 20
montage naturbetonständer auf rollen .....	p. 21
montage bodenverankerung .....	p. 22
inumbrina öffnen / schließen .....	p. 22
montage inumbrina im gargantua .....	p. 23
montage inumbrina im pantagruel .....	p. 23
pflege .....	p. 24

### FRANÇAIS

**P. 27**

contenu .....	p. 27
montage socle en béton .....	p. 28
montage socle en béton sur roues .....	p. 29
montage fixation dans au sol .....	p. 30
ouvrier / fermer inumbrina .....	p. 30
montage inumbrina dans gargantua .....	p. 31
montage inumbrina dans pantagruel .....	p. 31
entretien .....	p. 32

### ITALIANO

**P. 35**

contenuto .....	p. 35
montaggio base di calcestruzzo .....	p. 36
montaggio base di calcestruzzo su ruote .....	p. 37
montaggio diretto al suolo .....	p. 38
apertura / chiusura inumbrina .....	p. 38
montaggio inumbrina con gargantua .....	p. 39
montaggio inumbrina con pantagruel .....	p. 39
manutenzione .....	p. 40

### ESPAÑOL

**P. 43**

contenido .....	p. 43
montaje base de hormigón .....	p. 44
montaje base de hormigón con ruedas .....	p. 45
montaje fijación directamente sobre el suelo .....	p. 46
abierto / cerca inumbrina .....	p. 46
montaje inumbrina con gargantua .....	p. 47
montaje inumbrina con pantagruel .....	p. 47
mantenimiento .....	p. 48

## CONTENUTO

### INUMBRINA EN BASE DI CALCESTRUZZO

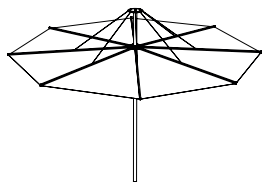

1 x inumbrina e tubo



4 x blocchi di calcestruzzo

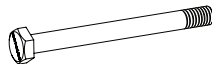

4 x bulloni M10x110

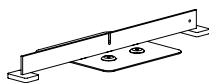

1 x telaio A

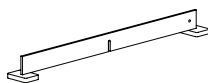

1 x telaio B



4 x scivoli di plastica

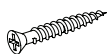

4 x bulloni M5x40



4 x tasselli

---

### INUMBRINA CON FISSAGGIO DIRETTO AL SUOLO

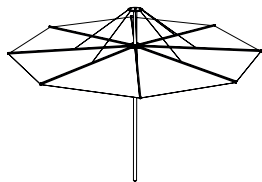

1 x inumbrina e tubo

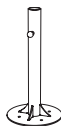

1 x tubo estensore

---

### INUMBRINA IN GARGANTUA / PANTAGRUËL

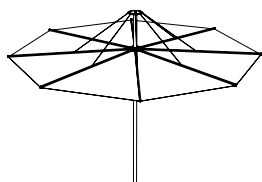

1 x inumbrina e tubo



1 x fissaggio



4 x bulloni M8x12



4 x rondella elastica

## MONTAGGIO INUMBRA EN BASE DI CALCESTRUZZO

### NECESSARIO PER IL MONTAGGIO



1 persone



chiave n. 17



cacciavite



+/- 30 min.

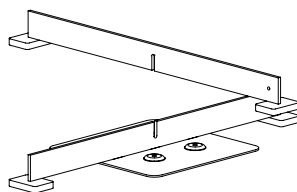

1. Posizionare il primo elemento della base a forma di croce sul suolo dove si desidera collocare l'ombrellone. Posizionarvi quindi sopra il secondo elemento in modo tale che le fessure siano allineate.

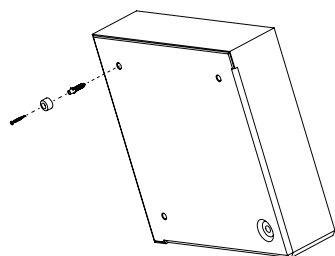

2. Fissare gli scivoli di plastica sotto i blocchi di calcestruzzo: inserire i tasselli in dotazione nei fori ciechi e poi fissare gli scivoli con l'ausilio delle viti in dotazione.

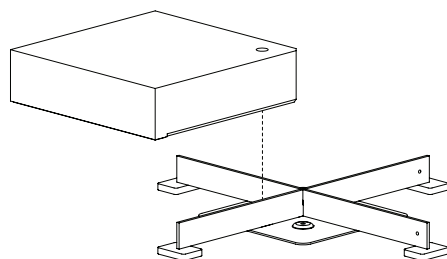

3. Collocare i quattro blocchi di calcestruzzo sulla base a forma di croce. Assicurarsi che i fori nei blocchi di calcestruzzo corrispondano ai fori nella piastra inferiore della base. Il lato con i bordi smussati è il lato inferiore.

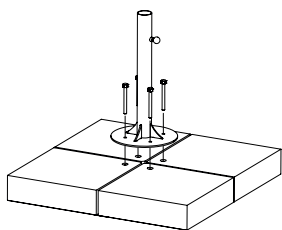

4. Posizionare quindi il tubo di acciaio inossidabile sui blocchi di calcestruzzo, assicurandosi che i fori del disco di acciaio inossidabile siano perfettamente allineati con i fori dei blocchi.

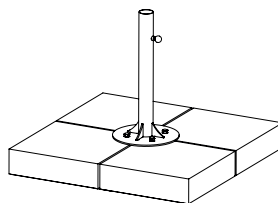

5. Si può ora fissare il tubo di acciaio inossidabile con l'ausilio dei quattro bulloni in dotazione. Serrarli con una chiave fissa da 17.

6. Inserire l'ombrellone Inumbrina nella base e bloccarlo ruotando la vite di arresto in senso orario. La vite di arresto è bloccata quando non è più possibile ruotare l'ombrellone attorno al suo asse.

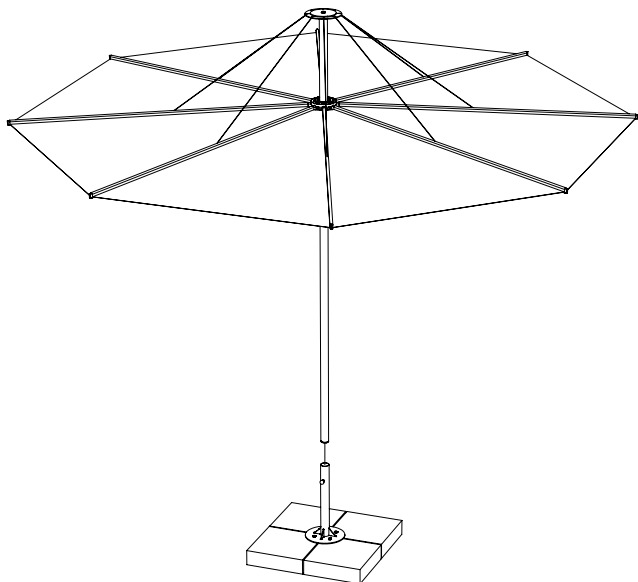

## MONTAGE BASE DI CEMENTO SU RUOTE

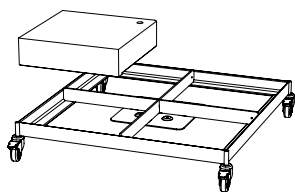

1. Collocare i quattro blocchi di calcestruzzo sulla base a forma di croce. Assicurarsi che i fori nei blocchi di calcestruzzo corrispondano ai fori nella piastra inferiore della base. Il lato con i bordi smussati è il lato inferiore.

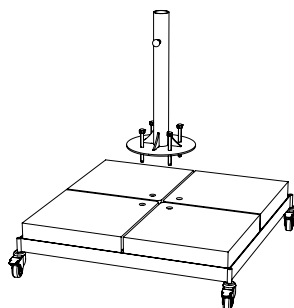

2. Posizionare quindi il tubo di acciaio inossidabile sui blocchi di calcestruzzo, assicurandosi che i fori del disco di acciaio inossidabile siano perfettamente allineati con i fori dei blocchi. Si può ora fissare il tubo di acciaio inossidabile con l'ausilio dei quattro bulloni in dotazione. Serrarli con una chiave fissa da 17.

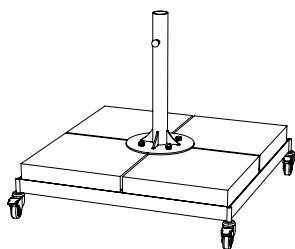

## MONTAGGIO INUMBRINA CON FISSAGGIO DIRETTO AL SUOLO

### NECESSARIO PER IL MONTAGGIO



1 persone



+/- 30 min.

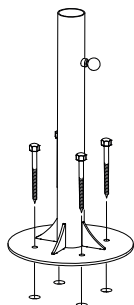

1. Posizionare il tubo inferiore in acciaio inossidabile nel punto in cui si desidera montare l'ombrellone e fissarlo al terreno con bulloni di ancoraggio (o con gli strumenti di fissaggio che meglio si adattano al tipo di terreno).
2. Inserire l'ombrellone Inumbrina nella base e bloccarlo ruotando la vite di arresto in senso orario. La vite di arresto è bloccata quando non è più possibile ruotare l'ombrellone attorno al suo asse.

### UTILIZZO

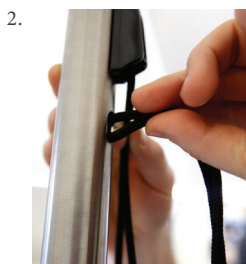
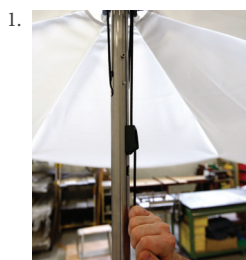

1. A questo punto si può incollare la fettuccia alla stecca così che non possa muoversi liberamente e in modo tale da non disturbare la vista.
2. Per aprire l'ombrellone, tirare la corda con decisione finché il telo non è in posizione orizzontale. Fissare la corda formando ripetutamente un otto.

## MONTAGGIO INUMBRINA CON GARGANTUA

### NECESSARIO PER IL MONTAGGIO



1 persona



chiave a brugola n. 5



+/- 20 min.

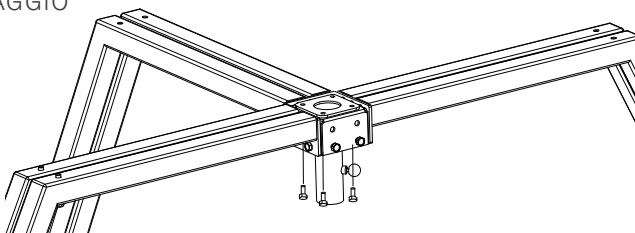

Posizionare l'elemento di fissaggio sul pezzo metallico centrale che unisce tra loro le 4 gambe di Gargantua come illustrato nella figura.

Dopo di che, rimontare il tavolo Gargantua. Inserire l'ombrellone Inumbrina nella base e bloccarlo ruotando la vite di arresto in senso orario. La vite di arresto è bloccata quando non è più possibile ruotare l'ombrellone.

## MONTAGGIO INUMBRINA CON PANTAGRUEL

### NECESSARIO PER IL MONTAGGIO



1 persona



chiave a brugola n. 5



+/- 20 min.

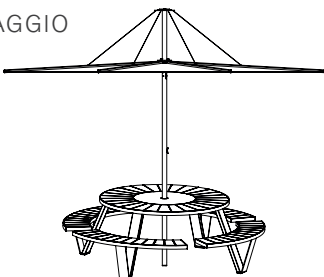

1. Rimuovere il lazy susan.

2. Posizionare l'elemento di fissaggio di Inumbrina38 nell'apertura centrale del piano del tavolo, con il cilindro rivolto verso il basso e la piastra quadrata verso l'alto.

3. Fissare quindi l'elemento al tavolo avvitando nello stesso i bulloni nella parte inferiore. Infine posizionare il piatto girevole al suo posto.

4. Inserire l'ombrellone Inumbrina nella base e bloccarlo ruotando la vite di arresto in senso orario. La vite di arresto è bloccata quando non è più possibile ruotare l'ombrellone attorno al suo asse.

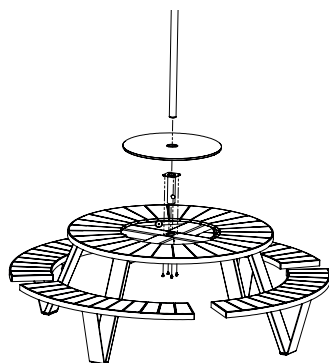

## MANUTENZIONE

### POLVERE

Pulire il telo dell'ombrellone e la fodera sciacquandoli con acqua e sapone per le mani sfregandoli con cura con una spazzola morbida. Evitare che il telo dell'ombrellone diventi molto sporco e ricoprirlo con la fodera il più spesso possibile.

Non pulire mai l'ombrellone con un pulitore ad alta pressione.

Non utilizzare detergenti: intaccano lo strato protettivo del tessuto.

### L'ACCIAIO INOSSIDABILE

L'acciaio inossidabile non è resistente all'acqua di mare. Soprattutto in un ambiente aggressivo (clima marittimo, cloro, pioggia acida, ambiente aggressivo industriale o urbano) consigliamo di pulire regolarmente la superficie. I prodotti per pulizia adeguati sono generalmente disponibili.

### AVVERTENZE

In caso di non utilizzo o vento molto forte, coprire l'ombrellone con la fodera (opzionale) o riporlo in casa per evitare che si sporchi o che si apra.

Non lasciare mai l'ombrellone incustodito quando è aperto.

Per motivi di aerazione la fodera non è impermeabile al 100%

Non lasciare chiuso Inumbrina se non è completamente asciutto. Non lasciarlo chiuso per molto tempo in condizioni di umidità.

Se non si utilizza l'ombrellone per molto tempo, riporlo come segue: in posizione verticale, asciugato perfettamente, in un luogo asciutto.



[WWW.EXTREMIS.BE](http://WWW.EXTREMIS.BE)

## LANGUAGES

### ENGLISH

**P. 3**

contents .....	p. 3
assembly concrete base .....	p. 4
assembly concrete wheel base .....	p. 5
assembly directly to the floor .....	p. 6
open / close inumbrina .....	p. 6
assembly inumbrina into gargantua .....	p. 7
assembly inumbrina into pantagruel .....	p. 7
maintenance .....	p. 8

### NEDERLANDS

**P. 11**

inhoud .....	p. 11
montage sokkel in beton .....	p. 12
montage sokkel in beton op wielen .....	p. 13
montage grondverankering .....	p. 14
inumbrina openen / sluiten .....	p. 14
montage inumbrina in gargantua .....	p. 15
montage inumbrina in pantagruel .....	p. 15
onderhoud .....	p. 16

### DEUTSCH

**P. 19**

inhalt .....	p. 19
montage naturbetonständer .....	p. 20
montage naturbetonständer auf rollen .....	p. 21
montage bodenverankerung .....	p. 22
inumbrina öffnen / schließen .....	p. 22
montage inumbrina im gargantua .....	p. 23
montage inumbrina im pantagruel .....	p. 23
pflege .....	p. 24

### FRANÇAIS

**P. 27**

contenu .....	p. 27
montage socle en béton .....	p. 28
montage socle en béton sur roues .....	p. 29
montage fixation dans au sol .....	p. 30
ouvrier / fermer inumbrina .....	p. 30
montage inumbrina dans gargantua .....	p. 31
montage inumbrina dans pantagruel .....	p. 31
entretien .....	p. 32

### ITALIANO

**P. 35**

contenuto .....	p. 35
montaggio base di calcestruzzo .....	p. 36
montaggio base di calcestruzzo su ruote .....	p. 37
montaggio diretto al suolo .....	p. 38
apertura / chiusura inumbrina .....	p. 38
montaggio inumbrina con gargantua .....	p. 39
montaggio inumbrina con pantagruel .....	p. 39
manutenzione .....	p. 40

### ESPAÑOL

**P. 43**

contenido .....	p. 43
montaje base de hormigón .....	p. 44
montaje base de hormigón con ruedas .....	p. 45
montaje fijación directamente sobre el suelo .....	p. 46
abierto / cerca inumbrina .....	p. 46
montaje inumbrina con gargantua .....	p. 47
montaje inumbrina con pantagruel .....	p. 47
mantenimiento .....	p. 48

## CONTENIDO

### INUMBRINA OP SOKKEL IN BETON

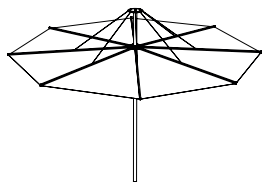

1 x inumbrina con tubo



4 x bloque de cemento

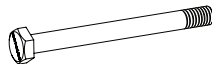

4 x tornillo M10x110

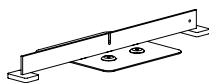

1 x chasis A

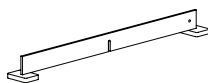

1 x chasis B



4 x collarine de plástico

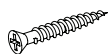

4 x tornillo M5x40



4 x clavija

---

### INUMBRINA CON FIJACIÓN DIRECTAMENTE SOBRE EL SUELO

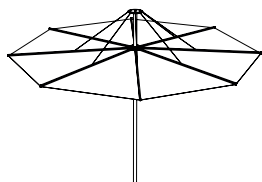

1 x inumbra con tubo

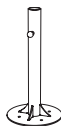

1 x palo prolongador

---

### INUMBRINA IN GARGANTUA / PANTAGRUËL

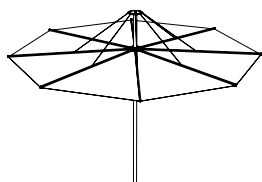

1 x inumbrina con tubo



1 x pieza de fijación



4 x tornillo M8x12



4 x arandela de resorte

# MONTAJE INUMBRA EN BASE DE HORMIGÓN

## UTENSILOS



1 persona



llave fija no. 17



destornillador



+/- 30 min.

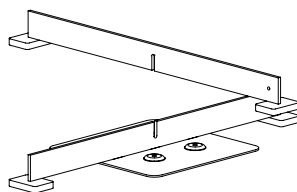

1. Ponga la primera pieza de la cruz de posición sobre el suelo en el lugar donde va a montar el parasol. Luego, desplace la segunda pieza por encima, de manera que las ranuras coincidan.

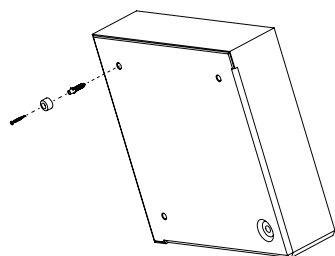

2. Fije los collarines de plástico bajo los bloques de cemento: ponga la clavija suministrada en el agujero ciego y fije el collarín mediante el tornillo suministrado.

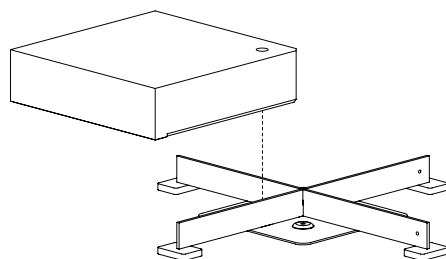

3. Ponga ahora los cuatro bloques de cemento en la cruz de posición. Asegúrese que las aberturas de los bloques de cemento coincidan con las aberturas de la parte inferior de la cruz de posición. El lado donde las esquinas están recortadas es el lado inferior.

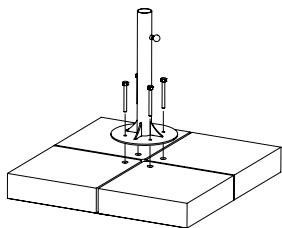

4. Ponga ahora el mástil de acero inoxidable sobre los bloques de cemento y asegúrese que los agujeros del disco de acero inoxidable coincidan con los agujeros de los bloques de cemento.

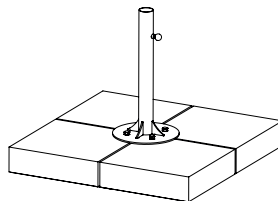

5. El mástil de acero inoxidable puede fijarse ahora con los 4 pernos suministrados. Ajústelo con una llave 17.

6. Luego, coloque el parasol Inumbrina en la base y bloquee el, girando el tornillo de ajuste en el sentido de las agujas del reloj. Cuando el Inumbrina ya no puede girar en torno a su propio eje, el tornillo de ajuste está bien cerrado.

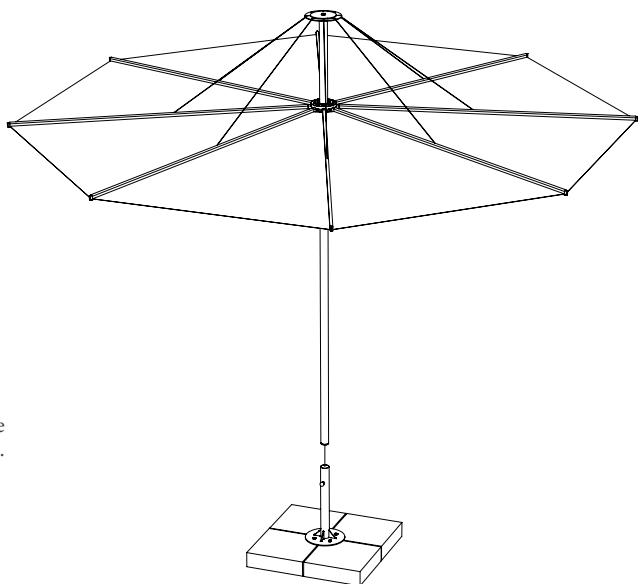

## BASE DE HORMIGÓN EN RUEDAS

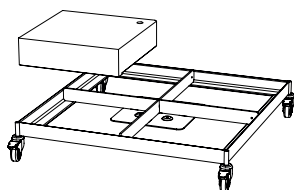

1. Ponga ahora los cuatro bloques de cemento en la cruz de posición. Asegúrese que las aberturas de los bloques de cemento coincidan con las aberturas de la parte inferior de la cruz de posición. El lado donde las esquinas están recortadas es el lado inferior.

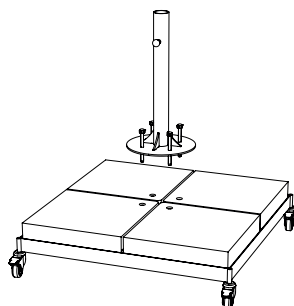

2. Ponga ahora el mástil de acero inoxidable sobre los bloques de cemento y asegúrese que los agujeros del disco de acero inoxidable coincidan con los agujeros de los bloques de cemento. El mástil de acero inoxidable puede fijarse ahora con los 4 pernos suministrados. Ajústelo con una llave 17.

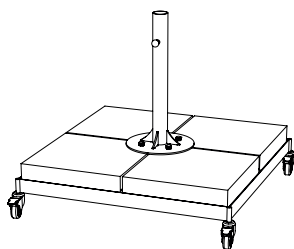

# MONTAJE INUMBRINA CON FIJACIÓN DIRECTAMENTE SOBRE EL SUELO

## UTENSILOS



1 persona



+/- 30 min.

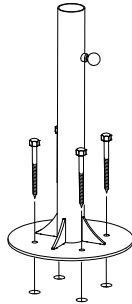

1. Coloque el tube inferior de acero inoxidable donde quiere instalar el parasol y átelo bien al suelo por medio de pernos de anclaje (o las fijaciones más aptas para su suelo).
2. Luego, coloque el parasol Inumbrina en la base y bloqueeo, girando el tornillo de ajuste en el sentido de las agujas del reloj. Cuando el Inumbrina ya no puede girar en torno a su propio eje, el tornillo de ajuste está bien cerrado.

## EMPLEO

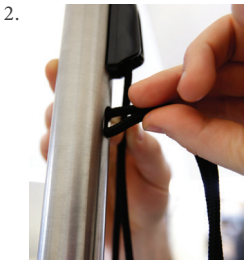
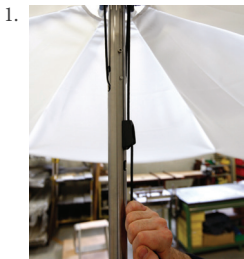

1. Ahora puede pegar la cinta contra la ballena, para que no pueda mover libremente y quitar la vista.
2. Para abrir el parasol, tire el cordón hasta que la superficie de la tela esté casi completamente horizontal. Fíjelo haciendo varios ochos.

## MONTAJE INUMBRINA EN GARGANTUA

### UTENSILIOS



1 persona



llave macho hexagonal nr. 5



+/- 20 min.

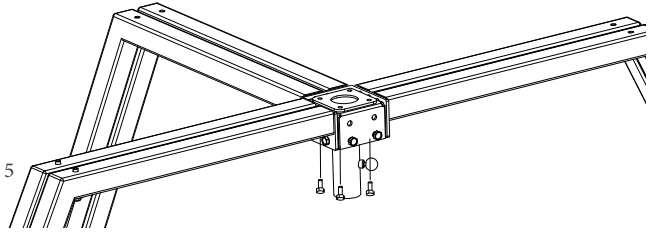

Montre le pieza de fijación en la pieza metálica central que conecta los 4 pies de la Gargantua, como puede ver en la figura siguiente.

Después vuelva a montar su mesa Gargantua. Luego, coloque el parasol Inumbrina en la base y bloquéelo, girando el tornillo de ajuste en el sentido de las agujas del reloj. Cuando el Inumbrina ya no puede girar en torno a su propio eje, el tornillo de ajuste está bien cerrado.

## MONTAJE INUMBRINA EN PANTAGRUEL

### UTENSILIOS



1 persona



llave macho hexagonal nr. 5



+/- 20 min.

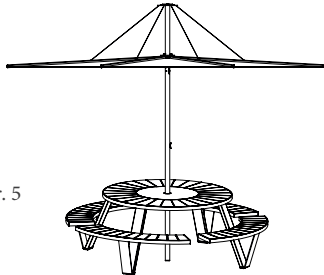

1. Quitar el lazy susan.

2. Coloque la pieza de fijación Inumbrina38 en la abertura central del tablero. Oriente el cilindro hacia abajo y la plaqueta cuadrada hacia arriba.

3. Luego entornille esta pieza en la mesa pasando los tornillos por debajo de la mesa. Meta después la bandeja giratoria en su sitio en la mesa.

4. Luego, coloque el parasol Inumbrina en la base y bloquéelo, girando el tornillo de ajuste en el sentido de las agujas del reloj. Cuando el Inumbrina ya no puede girar en torno a su propio eje, el tornillo de ajuste está bien cerrado.

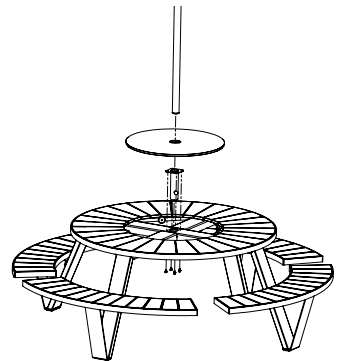

## MANTENIMIENTO

### POLVO

Limpie la lona del parasol y la funda lavándolos con agua y jabón y frotándolos con cuidado con un cepillo suave. Asegúrese en primera instancia que la tela del parasol no se ensucie mucho y ponga la funda sobre el parasol lo más a menudo posible.

No use nunca sistemas de inyección de agua a presión para limpiar el parasol.

No use detergentes, pues pueden perjudicar la capa protectora de la tela.

### ACERO INOXIDABLE

El acero inoxidable no es resistente al agua de mar. Especialmente en un entorno agresivo (clima marítimo, cloro, lluvia ácida, entorno industrial o urbano agresivo) recomendamos la limpieza frecuente de las superficies; los productos necesarios para ello están generalmente disponibles.

### CUIDADO!

Si no se emplea el parasol o cuando hay mucho viento, cubra el Inumbriña con la funda (opcional) o póngola dentro para evitar que se abra a causa del viento o que se ensucia.

No deje el parasol abierto sin vigilancia.

La funda no es 100% impermeable, a fin de que tenga ventilación.

No deje Inumbriña sin cerrar si no está completamente seco. No lo deje mucho tiempo cerrado si está húmedo.

Si no usa el parasol durante mucho tiempo, guárdelo en posición vertical, perfectamente seco, y en un lugar seco.



[WWW.EXTREMIS.BE](http://WWW.EXTREMIS.BE)

**extremis<sup>®</sup>**

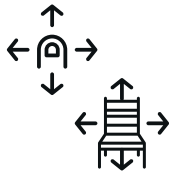

## **3D PLANNER & CONFIGURATOR**

Check out the Extremis app:  
Take a picture of your garden  
and drag&drop tools for  
togetherness in it!

**[WWW.EXTREMIS.COM](http://WWW.EXTREMIS.COM)**

# extremis®

**Extremis NV**  
Couthoflaan 20b  
B - 8972 Poperinge  
t +32 57 346020  
info@extremis.com



for more products go to  
[WWW.EXTREMIS.COM](http://WWW.EXTREMIS.COM)

All images, ideas, designs and design content are the intellectual property of Extremis and may not be copied, imitated or used, in whole or in part, without the prior written permission of Extremis.