

# extremis<sup>®</sup>

## Price list

€ — EN — 2025  
Recommended retail price ex. VAT









## **Tools for togetherness**

## Hi there!

---

Good design, ethical production and quality materials come at a fair price (list), and we should all be aware of that. However, in every minute of the design process, we do our absolute best to achieve the highest level of eco-efficiency by reducing transport volumes and waste. So, every tool for togetherness has a long history, even before it's being used by you. Designed logically and ecologically, solidly engineered after a thorough search and selection of quality materials, and then carefully made in Belgium. The result? An Extremis piece that you can love for a lifetime, something to pass on to the next generations. We are more than proud to welcome you to our price list.

	<p>ARE YOU SURE... this is the latest version? Check the expiration date on the next page, or go to <a href="http://www.extremis.com/pl">www.extremis.com/pl</a></p>
	<p>DEALER PORTAL Is the product in stock and ready to ship? Let's order it online! <a href="http://www.extremis.com/portal">www.extremis.com/portal</a></p>
	<p>PCON Don't forget, we are also on pCon planner. <a href="http://www.extremis.com/pcon">www.extremis.com/pcon</a></p> 

## Choose wisely

---

We offer great quality products, but every material has its own limits.

Don't expect wood to be perfectly smooth for years without any maintenance. After all, you don't expect your teeth to stay white if you don't brush them! Outdoor furniture also needs regular cleaning and some basic maintenance, especially in humid or polluted environments and if used intensively. Find out more in our materials section further on, or go to [www.extremis.com/maintenance](http://www.extremis.com/maintenance).

## We ♥ your project

---

If an order exceeds 5 pieces of one item, we consider it as a 'special' order. The lead time will differ from standard lead times, and other conditions might be applied to dimensions, colors or fabrics on request. There is one exception: our Sticks collection has a maximum standard order amount of 20 pieces of each item.

## Refurbishment tools







---

Every tool for togetherness has a long history, even before it's being used by you. Designed logically and ecologically, solidly engineered and made in Belgium with a selection of quality materials.

To extend the lifespan of our furniture even more, we offer spare parts. As every Extremis piece is designed with an efficient assembly process in mind, replacing a certain part is rather easy, and with straightforward videos that explain each step, you'll easily give a new life to your tool for togetherness. Find out more on [www.extremis.com/refurbishment](http://www.extremis.com/refurbishment)

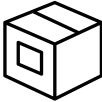
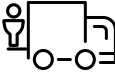
## General sales conditions

Because we hold a large number of components in stock and produce locally, most of the articles have short leadtimes.

<p>€ 5185 GAR001</p>	<p>Recommended retail price ex. VAT</p>
	<p>Customized item, payable in advance, ask for lead time</p>
	<p>Orders must be confirmed by Extremis. These confirmations are final and binding: check them and advise about possible mistakes within 24 hours.</p>
	<p>The Buyer cannot cancel, withdraw, or modify orders without Extremis' written permission. If such a request is approved, there will be an associated cost as outlined in our General Terms and Conditions of Sale (<a href="http://www.extremis.com/termsandconditions">www.extremis.com/termsandconditions</a>).</p>
	<p>Delivery is door-to-door on street level to the Extremis dealer's warehouse. Drop shipping to the B2C end user is not possible.</p>
	<p>For DAP deliveries, one driver and one truck tailgate are included. If you need extra services, you can request them for an additional fee using the rates listed on page 6.</p>
	<p>If you make changes to the delivery address after we confirm your order, an extra fee of € 75 will apply.</p>
	<p>If the Buyer provides an incorrect address, contact details or opening hours and our transport company has to make a second delivery attempt, there will be an additional charge of € 150.</p>
	<p>We may send products in disassembled form. It is the Buyer's responsibility to assemble and install the product with the help of specialized assemblers and follow the instructions provided by Extremis.</p>
	<p>We offer a standard 2-year warranty on all products. For more information about the full warranty, visit <a href="http://www.extremis.com/warranty">www.extremis.com/warranty</a>.</p>

# Transport

We understand the importance of convenience when it comes to transport, and that's why we have a comprehensive overview of our transport costs and services. We offer a variety of services and transport solutions that are tailored to all your needs, no matter how special. Take a look at the grid below for more information! Please note that these services will apply to every separate order. Transport costs and services ex. VAT. Each address must be approved by Extremis.

	Belgium / The Netherlands / Luxemburg / Germany / Austria / Switzerland <sup>3</sup> / France	Italy <sup>2</sup> / Spain <sup>2</sup> / Portugal <sup>2</sup> / Denmark / Sweden / Norway <sup>3</sup> / Finland / UK <sup>3</sup> / Ireland	Rest of the world
<b>Incoterm</b>	DAP	DAP	FCA-A
<b>Free delivery as from net order value of</b>	€ 1500	€ 2500	
<b>Transport cost below the net order value</b>	€ 125 Temporarily € 0 via dealer portal	€ 250 Temporarily € 0 via dealer portal	

## ADDITIONAL TRANSPORT SERVICES

Tailgate	Included	Included	
Forklift truck	+ € 150	+ € 150	
Change address	+ € 75	+ € 75	
Direct delivery (B2B) + Fixed day delivery	+ € 500	+ € 500	
Direct delivery (B2B) + Fixed day & timeslot delivery	+ € 650	+ € 650	
Second delivery attempt	+ € 150	+ € 150	
Address not reachable with 18-m truck	+ € 50	+ € 50	

## EXPORT DOCUMENTS

<b>Ex-1 Document<sup>3</sup></b>	€ 50 (Switzerland) Temporarily € 0 via dealer portal	€ 50 (UK / Norway) Temporarily € 0 via dealer portal	€ 50
----------------------------------	---	---	------

## IMPORT DOCUMENTS



<b>Ex-1 Document</b>		€ 50 (UK / Norway)	
----------------------	--	--------------------	--

<sup>2</sup> Delivery to mainland only / Islands on request at extra charge

<sup>3</sup> UK, Switzerland & Norway: import duties and import customs clearance are not included



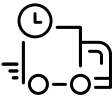

# Incoterms



Need to know which Incoterm applies to you? We've got you covered with an easy-to-understand grid that explains exactly what each Incoterm includes. Find the one that's applicable for your location and get the services you need.

	 Loading & export customs	 Carriage to destination	 Import customs clearance	 Import duties
DAP	✓	✓	✗	✗
FCA-A	✓	✗	✗	✗
EXW	✗	✗	✗	✗

# Icons explained

Look at these icons, they are amazing, and moreover, they'll give you some valuable information regarding our products.

	Return to index
	These are our fast runners, which tend to ship faster. Visit the Extremis Dealer Portal for current leadtimes
	Wheelchair accessible
	Charging module possible

	I am parasol ready!
	I'm a perfect match with this table!
	Watch out, my pole is xxx mm thick



Acacia 10



AMAi 12

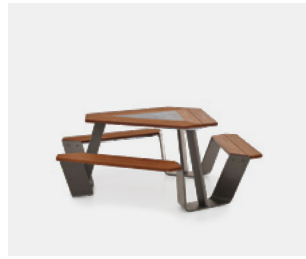

Anker 28



Bistroo 30

NEW OPTION

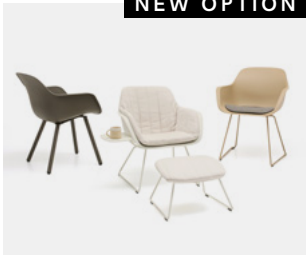

Captain's Chair 34



Deco cushions 40



Gargantua 42



Hopper bench 44



Hopper bench AA 44



Hopper combo 48



Hopper combo AA 49



Hopper picnic 52



Hopper picnic AA 54



Hopper shade 66



Inumbra 68



Inumbrina 72



Kosmos 76



Kosmos shade 80

NEW OPTION

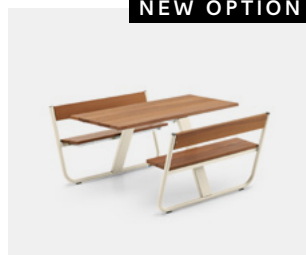

Manille 84



Marina combo 88





Marina picnic 90



Marina double desk 94



Marina table 96



Marina high table 98

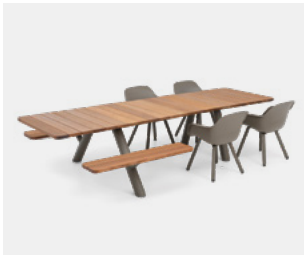

Panigiri combo 102



Panigiri picnic 102



Panigiri table 102



Pantagruel picnic 108

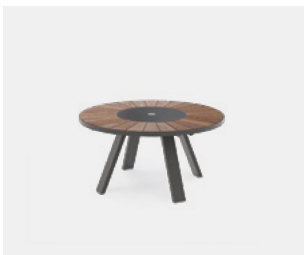

Pantagruel table 112



Pantagruel high table 114



Picnik 116



Sensu 118



Sol+Luna 128



Sticks 134



Tiki 138



Tiki table 146



Virus 148



Walrus 152



Maintenance tools 180

**This is an interactive PDF**

You can easily navigate from the index to the product pages, allowing you to smoothly jump from one page to the other. Our price list has never been more alive!

# Acacia

© design by Dirk Wynants

This compact, asymmetrical, Acacia-shaped umbrella fits the limited space of a balcony or small patio. Its clever design lets you create all the shade of a larger umbrella with a much reduced surface area. Simply use the handle and turn Acacia to the sun. Instead of closing the umbrella, simply remove the canvas and store it in the bag. What's left is a beautiful tree-like sculpture that can weather the year outdoors.

Add parasol base(s) or fix to the ground.









 Check availability  
www.extremis.com/portal

 ø34 mm

Outer dimensions (l x w x h): 231 x 235 x 189/236 cm

White PU coated polyester fabric + Structured powder coated stainless steel pole & tubes + Galvanized steel foot to use as floor fastening

Storage bag for canopy included

		<b>OFF WHITE</b> RAL9002	<b>€ 2055</b> ACA447
		<b>VERDIGRIS</b> RGB 133 147 142	<b>€ 2055</b> ACA350
		<b>REED GREEN</b> RAL6013	<b>€ 2055</b>  ACA351
		<b>COPPER BROWN</b> RAL8004	<b>€ 2055</b> ACA352
		<b>COLOR ON REQUEST</b> Only RAL colors Startup fee € 300 (ex. VAT)	<b>€ 2365</b> ACA357



## Friends of the product

**Virus**  
standard tabletop

→ p148



## PARASOL BASE

Add a parasol base of your choice

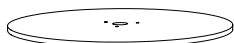

**LIGHTWEIGHT**  
1 galvanized steel base plate  
Recommended to combine with Virus  
ø 48 cm - 15 kg

€ 180   
ACA010

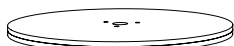

**STANDARD**  
2 galvanized steel base plates  
ø 48 cm - 30 kg

€ 360   
ACA011



**HEAVY DUTY**  
3 galvanized steel base plates  
ø 48 cm - 45 kg

€ 540   
ACA012

## ACACIA COMBINATIONS

With Virus

Acacia + Virus 3-seater



Acacia + Virus 4-seater



Acacia + Virus 5-seater

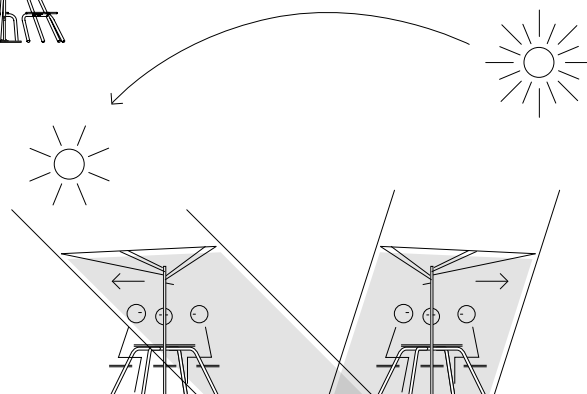

# AMAi galvanized

© design by Dirk Wynants

AMAi is the flexibility that you desire, all the time, indoors and outdoors. Two A-shaped side frames provide a solid construction where multifunctional magic finds its purpose. In between these frames, you can position the tabletop into two heights: standard or high. Thanks to the innovative design, even a single person can smoothly slide the tabletop from 'sitting height' into 'standing height' and vice versa.

Add more A-frames to extend togetherness into infinity. One AMAi seats 8 people and stands even more.



Check availability  
www.extremis.com/portal







Wheelchair accessible  
→ p172

## BASE MODULE

Outer dimensions (l x w x h): 304 x 113 x 230 cm

Galvanized steel A-frames, footrest & top tube | Hellwood = 100% PEFC

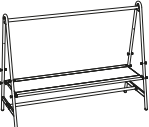
Can not be combined with a shade or a lighting & charging module





		 <b>OFF WHITE</b> RAL9002 Tabletop	  <b>HELLWOOD</b> Thermally treated wood Tabletop centerplate
	 <b>GALVANIZED STEEL</b> A-frames, footrest & top tube	<b>€ 4240</b> AMA739	<b>€ 4510</b> AMA740

## EXTENSION MODULE

Outer dimensions (l x w x h): 298 x 113 x 230 cm

Galvanized steel A-frame, footrest & top tube | Hellwood = 100% PEFC

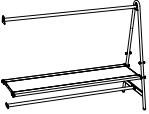
Can not be combined with a shade or a lighting & charging module

		 <b>OFF WHITE</b> RAL9002 Tabletop	  <b>HELLWOOD</b> Thermally treated wood Tabletop centerplate
	 <b>GALVANIZED STEEL</b> A-frame, footrest & top tube	<b>€ 3275</b> AMA744	<b>€ 3545</b> AMA745

Powder coated tabletop

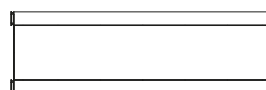

Hellwood tabletop

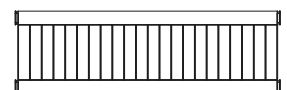

The side profiles of the tabletop are always structured powder coated aluminium Off white RAL9002



## Friends of the product

AMAi  
benches



→ p26

Captain's Chairs



→ p34

Tiki stool  
& bar stool



→ p138

### ADD-ON TABLE

Outer dimensions (l x w): 87 x 40 cm

Structured powder coated aluminium

Can be used in both the standard & high position

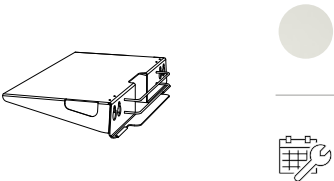
	<b>OFF WHITE</b> RAL9002	<b>€ 805</b> AMA711
	<b>COLOR ON REQUEST</b> Only RAL colors Startup fee € 300 (ex. VAT)	<b>€ 925</b> AMA066

### MONITOR HOLDER

VESA connection for computer monitor, not for a television

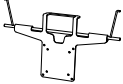
	Stainless steel	<b>€ 210</b> AMA068
---	-----------------	------------------------

### TABLETOP FIXATION

Can be used in both the standard & high position

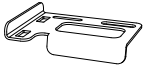
	Stainless steel 1 set: 2 pieces	<b>€ 340/set</b> AMA067
---	------------------------------------	----------------------------

### STANDARD FEET

	Black 1 set: 2 pieces	<b>€ incl.</b>
---	--------------------------	----------------

### LEVELING FEET

We advise to use these for uneven surfaces

You need 1 set for every A-frame

	Black 1 set: 2 pieces	<b>€ 80/set</b> AMA070
---	--------------------------	---------------------------

### FLOOR FASTENING FEET

Can also be added to the AMAi bench

You need 1 set for every A-frame | Height adjustable

Screws not included

	Stainless steel 1 set: 2 pieces	<b>€ 415/set</b> AMA069
---	------------------------------------	----------------------------

# AMAi powder coated

© design by Dirk Wynants

AMAi is the flexibility that you desire, all the time, indoors and outdoors. Two A-shaped side frames provide a solid construction where multifunctional magic finds its purpose. In between these frames, you can position the tabletop into two heights: standard or high. Thanks to the innovative design, even a single person can smoothly slide the tabletop from 'sitting height' into 'standing height' and vice versa.

Add more A-frames to extend togetherness into infinity. One AMAi seats 8 people and stands even more.



Check availability  
www.extremis.com/portal



Wheelchair accessible  
→ p172









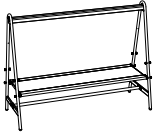

Shades → p18  
Accessories → p18

## BASE MODULE

Outer dimensions (l x w x h): 304 x 113 x 230 cm

Structured powder coated stainless steel A-frames with aluminium top profile and Galvanized steel footrest | Hellwood = 100% PEFC

	 <b>POWDER COATED</b> <i>Tabletop</i>	 <b>HELLWOOD</b> <i>Thermally treated wood</i> <i>Tabletop centerplate</i>
 <b>BLACK</b> RAL9005 A-frames & top profile	<b>€ 4875</b> AMA019	<b>€ 5145</b> AMA018
 <b>BEACH BEIGE</b> RAL1019 A-frames & top profile	<b>€ 4875</b> AMA653	<b>€ 5145</b> AMA645
 <b>OFF WHITE</b> RAL9002 A-frames & top profile	<b>€ 4875</b> AMA686	<b>€ 5145</b> AMA688
 <b>COPPER BROWN</b> RAL8004 A-frames & top profile	<b>€ 4875</b> AMA025	<b>€ 5145</b> AMA024
 <b>COLOR ON REQUEST</b> Only RAL-colors A-frames & top profile Startup fee € 300 (ex. VAT)	<b>€ 5560</b> AMA028	<b>€ 5870</b> AMA027

Powder coated tabletop

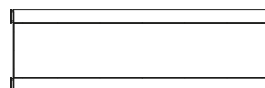

Hellwood tabletop

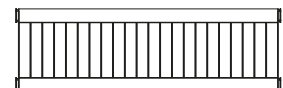

The side profiles of the tabletop are always structured powder coated aluminium



## Friends of the product

AMAi  
benches



→ p26

Captain's Chairs



→ p34

Tiki stool  
& bar stool



→ p138







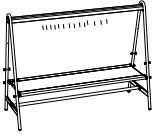

## BASE MODULE WITH LIGHTING & CHARGING MODULE

Outer dimensions (l x w x h): 304 x 113 x 230 cm

Structured powder coated stainless steel A-frames with aluminium top profile and Galvanized steel footrest | Hellwood = 100% PEFC

200 cm dimmable warm white LED light (3000 K) with a black powder coated cover plate (no other colors possible)

2 fast charging (60W) USB-C ports

	 <b>POWDER COATED</b> <i>Tabletop</i>	  <b>HELLWOOD</b> <i>Thermally treated wood                      Tabletop centerplate</i>
 <b>BLACK</b> RAL9005 A-frames & top profile	<b>€ 5830</b> AMA789	<b>€ 6100</b> AMA794
 <b>BEACH BEIGE</b> RAL1019 A-frames & top profile	<b>€ 5830</b> AMA790	<b>€ 6100</b> AMA795
 <b>OFF WHITE</b> RAL9002 A-frames & top profile	<b>€ 5830</b> AMA791	<b>€ 6100</b> AMA796
 <b>COPPER BROWN</b> RAL8004 A-frames & top profile	<b>€ 5830</b> AMA792	<b>€ 6100</b> AMA797
 <b>COLOR ON REQUEST</b> Only RAL-colors A-frames & top profile Startup fee € 300 (ex. VAT)	<b>€ 6515</b> AMA793	<b>€ 6825</b> AMA798

Powder coated tabletop

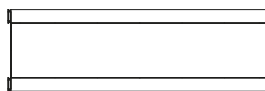

Hellwood tabletop

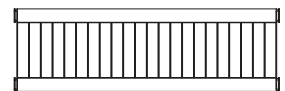

The side profiles of the tabletop are always structured powder coated aluminium

## POWER SUPPLY

One power supply can power 2 AMAi modules

A plug will need to be fitted afterwards by qualified people

Up to max. 300 W









	IP67 500 cm	<b>€ 295</b> AMA785
---	----------------	------------------------

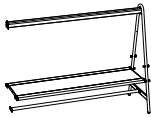

## EXTENSION MODULE

Outer dimensions (l x w x h): 298 x 113 x 230 cm

Structured powder coated stainless steel A-frame with aluminium top profile and Galvanized steel footrest | Hellwood = 100% PEFC

	 <p><b>POWDER COATED</b> <i>Tabletop</i></p>	  <p><b>HELLWOOD</b> <i>Thermally treated wood Tabletop centerplate</i></p>
 <p><b>BLACK</b> RAL9005 A-frame &amp; top profile</p>	<p><b>€ 3720</b> AMA031</p>	<p><b>€ 3990</b> AMA030</p>
 <p><b>BEACH BEIGE</b> RAL1019 A-frame &amp; top profile</p>	<p><b>€ 3720</b> AMA699</p>	<p><b>€ 3990</b> AMA701</p>
 <p><b>OFF WHITE</b> RAL9002 A-frame &amp; top profile</p>	<p><b>€ 3720</b> AMA698</p>	<p><b>€ 3990</b> AMA700</p>
 <p><b>COPPER BROWN</b> RAL8004 A-frame &amp; top profile</p>	<p><b>€ 3720</b> AMA037</p>	<p><b>€ 3990</b> AMA036</p>
 <p><b>COLOR ON REQUEST</b> Only RAL-colors A-frame &amp; top profile Startup fee € 300 (ex. VAT)</p>	<p><b>€ 4240</b> AMA040</p>	<p><b>€ 4550</b> AMA039</p>

Powder coated tabletop

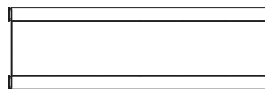

Hellwood tabletop

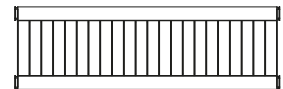

The side profiles of the tabletop are always structured powder coated aluminium









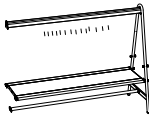

## EXTENSION MODULE WITH LIGHTING & CHARGING MODULE

Outer dimensions (l x w x h): 298 x 113 x 230 cm

Structured powder coated stainless steel A-frame with aluminium top profile and Galvanized steel footrest | Hellwood = 100% PEFC

200 cm dimmable warm white LED light (3000 K) with a black powder coated cover plate (no other colors possible)

2 fast charging (60W) USB-C ports

	 <p><b>POWDER COATED</b> <i>Tabletop</i></p>	 <p><b>HELLWOOD</b> <i>Thermally treated wood Tabletop centerplate</i></p>
 <p><b>BLACK</b> RAL9005 A-frame &amp; top profile</p>	<p><b>€ 4675</b> AMA799</p>	<p><b>€ 4945</b> AMA804</p>
 <p><b>BEACH BEIGE</b> RAL1019 A-frame &amp; top profile</p>	<p><b>€ 4675</b> AMA800</p>	<p><b>€ 4945</b> AMA805</p>
 <p><b>OFF WHITE</b> RAL9002 A-frame &amp; top profile</p>	<p><b>€ 4675</b> AMA801</p>	<p><b>€ 4945</b> AMA806</p>
 <p><b>COPPER BROWN</b> RAL8004 A-frame &amp; top profile</p>	<p><b>€ 4675</b> AMA802</p>	<p><b>€ 4945</b> AMA807</p>
 <p><b>COLOR ON REQUEST</b> Only RAL-colors A-frame &amp; top profile Startup fee € 300 (ex. VAT)</p>	<p><b>€ 5195</b> AMA803</p>	<p><b>€ 5505</b> AMA808</p>

Powder coated tabletop

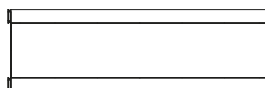

Hellwood tabletop

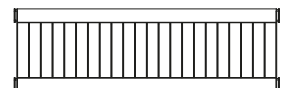

The side profiles of the tabletop are always structured powder coated aluminium

## POWER SUPPLY

One power supply can power 2 AMAi modules

A plug will need to be fitted afterwards by qualified people

Up to max. 300 W

	<p>IP67 500 cm</p>	<p><b>€ 295</b> AMA785</p>
---	------------------------	--------------------------------







## SHADES

Outer dimensions (l x w (x h))

White high-tech polyester fabric + Galvanized steel tubes

Fixates underneath the top profile | Can not be combined with the galvanized steel A-frame

Includes an extra powder coated profile at both sides for water drainage







		
	<b>SHADE</b> 282 x 301 cm	<b>MARKET SHADE</b> 282 x 301 x 23 cm <i>Extra sun protection flap on both sides</i>
	<b>BLACK</b> Profiles RAL9005 & White fabric € 1925 AMA124	€ 2235 AMA127
	<b>BEACH BEIGE</b> Profiles RAL1019 & White fabric € 1925 AMA130	€ 2235 AMA133
	<b>OFF WHITE</b> Profiles RAL9002 & White fabric € 1925 AMA131	€ 2235 AMA132
	<b>COPPER BROWN</b> Profiles RAL8004 & White fabric € 1925 AMA125	€ 2235 AMA128
	<b>COLOR ON REQUEST</b> Only RAL-colors (Profiles) Startup fee € 300 (ex. VAT) € 2210 AMA126	€ 2570 AMA129

## ADD-ON TABLE

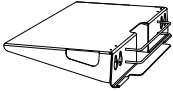
Outer dimensions (l x w): 87 x 40 cm

Structured powder coated aluminium

Can be used in both the standard & high position

		<b>BLACK</b> RAL9005 € 805 AMA063
		<b>BEACH BEIGE</b> RAL1019 € 805 AMA712
		<b>OFF WHITE</b> RAL9002 € 805 AMA711
		<b>COPPER BROWN</b> RAL8004 € 805 AMA064
		<b>COLOR ON REQUEST</b> Only RAL colors Startup fee € 300 (ex. VAT) € 925 AMA066

## MONITOR HOLDER

VESA connection for computer monitor, not for a television

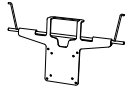

Stainless steel

€ 210

AMA068

## HANGING HOOK

Ideal to hang plants, cables, ...

Can not be combined with the galvanized steel top tube



Stainless steel

€ 80

AMA106

## TABLETOP FIXATION

Can be used in both the standard & high position



Stainless steel  
1 set: 2 pieces

€ 340/set

AMA067

## STANDARD FEET



Black  
1 set: 2 pieces

€ incl.

## LEVELING FEET

We advise to use these for uneven surfaces

You need 1 set for every A-frame



Black  
1 set: 2 pieces

€ 80/set

AMA070

## FLOOR FASTENING FEET

Can also be added to the AMAi bench

You need 1 set for every A-frame | Height adjustable

Screws not included



Stainless steel  
1 set: 2 pieces

€ 415/set

AMA069

## POWER SUPPLY

One power supply can power 2 AMAi modules

A plug will need to be fitted afterwards by qualified people

Up to max. 300 W



IP67  
500 cm

€ 295

AMA785

# AMAI catering station

© design by Dirk Wynants

The AMAi catering station is your ultimate party wingman. No more running back and forth to the kitchen while your guests wonder where you've gone. This convenient prep table, with integrated plate storage, lets you put the final touches on appetizers right where the fun is. With the optional bar add-on, you can elevate the experience with a high-top area for drinks. And when it's time to raise a toast, the optional glass holder makes sure your wine glasses are just an arm's length away.



Check availability  
[www.extremis.com/portal](http://www.extremis.com/portal)



Bar add-on → p23  
 Glassholder → p23  
 Shades → p24  
 Accessories → p24

## BASE MODULE

Outer dimensions (l x w x h): 304 x 113 x 230 cm

Structured powder coated stainless steel A-frames + Structured powder coated aluminium top profile & tabletop + Galvanized steel footrest

		<b>BLACK</b> RAL9005	<b>€ 6290</b> AMA089
		<b>BEACH BEIGE</b> RAL1019	<b>€ 6290</b> AMA650
		<b>OFF WHITE</b> RAL9002	<b>€ 6290</b> AMA713
		<b>COPPER BROWN</b> RAL8004	<b>€ 6290</b> AMA090
		<b>COLOR ON REQUEST</b> Only RAL colors Startup fee € 300 (ex. VAT)	<b>€ 7185</b> AMA092



## Friends of the product

Captain's Chairs  
 high

→ p37



Tiki  
 bar stool

→ p138









**BASE MODULE WITH LIGHTING & CHARGING MODULE**

Outer dimensions (l x w x h): 304 x 113 x 230 cm

Structured powder coated stainless steel A-frames with aluminium top profile and Galvanized steel footrest

200 cm dimmable warm white LED light (3000 K) with a black powder coated cover plate (no other colors possible)

2 fast charging (60W) USB-C ports

		<p><b>BLACK</b> RAL9005</p>	<p><b>€ 7245</b> AMA809</p>
		<p><b>BEACH BEIGE</b> RAL1019</p>	<p><b>€ 7245</b> AMA810</p>
		<p><b>OFF WHITE</b> RAL9002</p>	<p><b>€ 7245</b> AMA811</p>
		<p><b>COPPER BROWN</b> RAL8004</p>	<p><b>€ 7245</b> AMA812</p>
		<p><b>COLOR ON REQUEST</b> Only RAL colors Startup fee € 300 (ex. VAT)</p>	<p><b>€ 8140</b> AMA813</p>

**POWER SUPPLY**

One power supply can power 2 AMAi modules

A plug will need to be fitted afterwards by qualified people







Up to max. 300 W

	<p>IP67 500 cm</p>	<p><b>€ 295</b> AMA785</p>
---	------------------------	--------------------------------

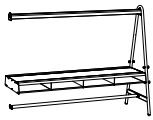
## EXTENSION MODULE

Outer dimensions (l x w x h): 298 x 113 x 230 cm

Structured powder coated stainless steel A-frame + Structured powder coated aluminium top profile & tabletop + Galvanized steel footrest

		<b>BLACK</b> RAL9005	<b>€ 5135</b> AMA093
		<b>BEACH BEIGE</b> RAL1019	<b>€ 5135</b> AMA655
		<b>OFF WHITE</b> RAL9002	<b>€ 5135</b> AMA715
		<b>COPPER BROWN</b> RAL8004	<b>€ 5135</b> AMA094
		<b>COLOR ON REQUEST</b> Only RAL colors Startup fee € 300 (ex. VAT)	<b>€ 5865</b> AMA096







## EXTENSION MODULE WITH LIGHTING & CHARGING MODULE

Outer dimensions (l x w x h): 298 x 113 x 230 cm

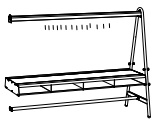
Structured powder coated stainless steel A-frame with aluminium top profile and Galvanized steel footrest

200 cm dimmable warm white LED light (3000 K) with a black powder coated cover plate (no other colors possible)

2 fast charging (60W) USB-C ports

		<b>BLACK</b> RAL9005	<b>€ 6090</b> AMA814
		<b>BEACH BEIGE</b> RAL1019	<b>€ 6090</b> AMA815
		<b>OFF WHITE</b> RAL9002	<b>€ 6090</b> AMA816
		<b>COPPER BROWN</b> RAL8004	<b>€ 6090</b> AMA817
		<b>COLOR ON REQUEST</b> Only RAL colors Startup fee € 300 (ex. VAT)	<b>€ 6820</b> AMA818

## POWER SUPPLY

One power supply can power 2 AMAi modules

A plug will need to be fitted afterwards by qualified people

Up to max. 300 W







	IP67 500 cm	<b>€ 295</b> AMA785
--	----------------	------------------------

**BAR ADD-ON**

Outer dimensions (l x w x h): 286 x 31 x 37 cm

Structured powder coated aluminium tabletop & supports

Only possible in combination with the AMAi catering station

		<b>BLACK</b> RAL9005	<b>€ 1560</b> AMA097
		<b>BEACH BEIGE</b> RAL1019	<b>€ 1560</b> AMA651
		<b>OFF WHITE</b> RAL9002	<b>€ 1560</b> AMA716
		<b>COPPER BROWN</b> RAL8004	<b>€ 1560</b> AMA098
		<b>COLOR ON REQUEST</b> Only RAL colors Startup fee € 300 (ex. VAT)	<b>€ 1635</b> AMA100

**GLASSHOLDER**

Outer dimensions (l x w x h): 72 x 13 x 7 cm

	Stainless steel	<b>€ 155</b> AMA101
---	-----------------	------------------------

**AMAI CATERING STATION**

The perfect height to cook or prepare delicious meals and drinks, with convenient storage accessible from all sides.

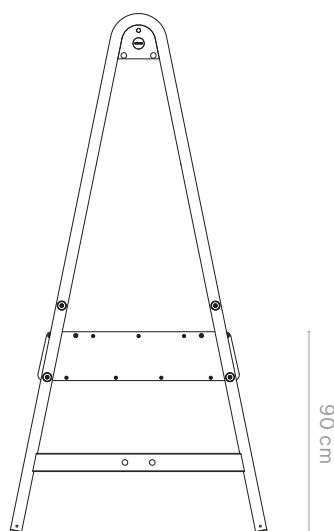

**AMAI CATERING STATION + BAR ADD-ON**

With the bar piece in place, you easily create a high apero corner to share delicious togetherness with friends while having the space to prepare more drinks and bites. Add the stackable Tiki bar stools for extra comfort.

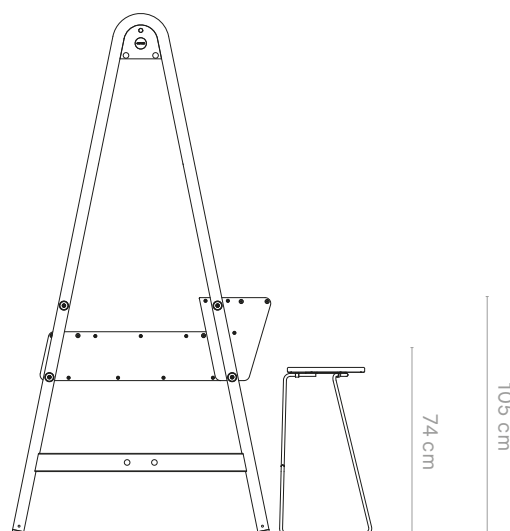







## SHADES

Outer dimensions (l x w (x h))

White high-tech polyester fabric + Galvanized steel tubes

Fixates underneath the top profile | Can not be combined with the galvanized steel A-frame

Includes an extra powder coated profile at both sides for water drainage







	 <b>SHADE</b> 282 x 301 cm	 <b>MARKET SHADE</b> 282 x 301 x 23 cm <i>Extra sun protection flap on both sides</i>
 <b>BLACK</b> Profiles RAL9005 & White fabric	<b>€ 1925</b> AMA124	<b>€ 2235</b> AMA127
 <b>BEACH BEIGE</b> Profiles RAL1019 & White fabric	<b>€ 1925</b> AMA130	<b>€ 2235</b> AMA133
 <b>OFF WHITE</b> Profiles RAL9002 & White fabric	<b>€ 1925</b> AMA131	<b>€ 2235</b> AMA132
 <b>COPPER BROWN</b> Profiles RAL8004 & White fabric	<b>€ 1925</b> AMA125	<b>€ 2235</b> AMA128
 <b>COLOR ON REQUEST</b> Only RAL-colors (Profiles) Startup fee € 300 (ex. VAT)	<b>€ 2210</b> AMA126	<b>€ 2570</b> AMA129

## ADD-ON TABLE

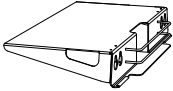
Outer dimensions (l x w): 87 x 40 cm

Structured powder coated aluminium

Can be used in both the standard & high position

	 <b>BLACK</b> RAL9005	<b>€ 805</b> AMA063
	 <b>BEACH BEIGE</b> RAL1019	<b>€ 805</b> AMA712
	 <b>OFF WHITE</b> RAL9002	<b>€ 805</b> AMA711
	 <b>COPPER BROWN</b> RAL8004	<b>€ 805</b> AMA064
	 <b>COLOR ON REQUEST</b> Only RAL colors Startup fee € 300 (ex. VAT)	<b>€ 925</b> AMA066



## MONITOR HOLDER

VESA connection for computer monitor, not for a television



Stainless steel

**€ 210**  
AMA068

## HANGING HOOK

Ideal to hang plants, cables, ...

Can not be combined with the galvanized steel top tube



Stainless steel

**€ 80**  
AMA106

## STANDARD FEET



Black  
1 set: 2 pieces

**€ incl.**

## LEVELING FEET

We advise to use these for uneven surfaces

You need 1 set for every A-frame



Black  
1 set: 2 pieces

**€ 80/set**  
AMA070

## FLOOR FASTENING FEET

Can also be added to the AMAi bench

You need 1 set for every A-frame | Height adjustable

Screws not included



Stainless steel  
1 set: 2 pieces

**€ 415/set**  
AMA069

## POWER SUPPLY

One power supply can power 2 AMAi modules

A plug will need to be fitted afterwards by qualified people

Up to max. 300 W



IP67  
500 cm

**€ 295**  
AMA785

# AMAi benches

© design by Dirk Wynants

Minimalistic and lightweight, yet sturdy and weatherproof, the AMAi benches match the unique design of the AMAi table, while also fitting a wide range of settings on their own. Opt for a fixed low bench or for a height-adjustable bench that follows the chosen table height of AMAi. Sit on the bench at traditional height or flip the backrest to the other side to create a high bench to lean against.









Check availability  
[www.extremis.com/portal](http://www.extremis.com/portal)

## BENCH

Outer dimensions (l x w x h): 249 x 40 x 46/51 cm

Structured powder coated stainless steel legs & Structured powder coated aluminium bench top  
 4 to 5 people

		<b>BLACK</b> RAL9005	<b>€ 1400</b> AMA071
		<b>BEACH BEIGE</b> RAL1019	<b>€ 1400</b> AMA662
		<b>OFF WHITE</b> RAL9002	<b>€ 1400</b> AMA718
		<b>COPPER BROWN</b> RAL8004	<b>€ 1400</b> AMA072
		<b>COLOR ON REQUEST</b> Only RAL colors Startup fee € 300 (ex. VAT)	<b>€ 1610</b> AMA074



### Friends of the product

AMAi  
galvanized



→ p12

AMAi  
powder coated









→ p14

## HILO BENCHES

Outer dimensions (l x w x h)

Structured powder coated stainless steel legs & Structured powder coated aluminium bench top & adjustable backrest









		 <b>SHORT</b> 117 x 40 x 46/75 cm 2 people	 <b>LONG</b> 249 x 40 x 46/75 cm 4 to 5 people
	<b>BLACK</b> RAL9005	€ 1845 AMA075	€ 2040 AMA102
	<b>BEACH BEIGE</b> RAL1019	€ 1845 AMA669	€ 2040 AMA734
	<b>OFF WHITE</b> RAL9002	€ 1845 AMA723	€ 2040 AMA730
	<b>COPPER BROWN</b> RAL8004	€ 1845 AMA076	€ 2040 AMA103
	<b>COLOR ON REQUEST</b> Only RAL colors Startup fee € 300 (ex. VAT)	€ 2120 AMA078	€ 2350 AMA105

## BACKREST CUSHIONS FOR HILO BENCHES

Outer dimensions (l x t)

Sunbrella upholstery for the backrest of the HiLo benches

Please store the cushions inside when not in use

		 <b>SHORT</b> 99 x 2 cm	 <b>LONG</b> 233 x 2 cm
	<b>GREY CHINÉ</b> Sunbrella® Natté	€ 170 AMA107	€ 365 AMA112
	<b>COCONUT</b> Sunbrella® Savane	€ 170 AMA671	€ 365 AMA748
	<b>MARBLE</b> Sunbrella® Lopi	€ 235 AMA108	€ 470 AMA113
	<b>COLOR ON REQUEST 1</b> Only for Sunbrella Natté, Solids, Savane & Heritage	€ 200 AMA109	€ 390 AMA114
	<b>COLOR ON REQUEST 2</b> Only for Sunbrella Chartres	€ 225 AMA110	€ 440 AMA115
	<b>COLOR ON REQUEST 3</b> Only for Sunbrella Lopi & Domino	€ 260 AMA111	€ 495 AMA116

# Anker

© design by Dirk Wynants

Anker is our answer to a growing need for optimal use of space. The compact 6-seater picnic table encourages one-on-one conversations, but its appearance invites people to come on board. Just slide in at the sides of the benches, without having to lift your leg. The solid frame is very robust and weather resistant. Configure Anker as you wish: choose galvanized steel or a powder coated finish, combined with Hellwood or Iroko hardwood tabletop and benches.



Check availability  
[www.extremis.com/portal](http://www.extremis.com/portal)



Charging module  
 → p178









ø35 mm

## GALVANIZED STEEL LEGS

Outer dimensions (ø x h): 217 x 74 cm

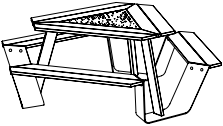
Powder coated centerplate

Hellwood = 100% PEFC

		  <b>HELLWOOD</b> <i>Thermally treated wood                      tabletop &amp; benches</i>	 <b>IROKO</b> <i>Tropical hardwood                      tabletop &amp; benches</i>	
		<b>GALVANIZED BL</b> & Black centerplate RAL9005	<b>€ 4320</b> ANK008	<b>€ 4595</b> ANK002
		<b>GALVANIZED EA</b> & Earth centerplate RGB 88 88 84	<b>€ 4320</b> ANK009	<b>€ 4595</b> ANK001
		<b>GALVANIZED OW</b> & Off white centerplate RAL9002	<b>€ 4320</b> ANK355	<b>€ 4595</b> ANK354
		<b>GALVANIZED VE</b> & Verdigris centerplate RGB 133 147 142	<b>€ 4320</b> ANK312	<b>€ 4595</b> ANK311



### Friends of the product

Inumbrina  
 medium

→ p73











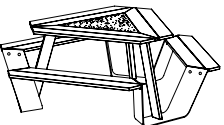

### POWDER COATED LEGS

Outer dimensions (ø x h): 217 x 74 cm

The centerplate is powder coated in the same color as the legs

Hellwood = 100% PEFC

		  <b>HELLWOOD</b> <i>Thermally treated wood tabletop &amp; benches</i>	 <b>IROKO</b> <i>Tropical hardwood tabletop &amp; benches</i>	
		<b>BLACK</b> RAL9005	<b>€ 4420</b> ANK011	<b>€ 4695</b> ANK004
		<b>EARTH</b> RGB 88 88 84	<b>€ 4420</b> ANK012	<b>€ 4695</b> ANK005
		<b>OFF WHITE</b> RAL9002	<b>€ 4420</b> ANK353	<b>€ 4695</b> ANK351
		<b>VERDIGRIS</b> RGB 133 147 142	<b>€ 4420</b> ANK310	<b>€ 4695</b> ANK308
		<b>COLOR ON REQUEST</b> Only RAL colors Startup fee € 300 (ex. VAT)	<b>€ 4665</b> ANK014	<b>€ 4940</b> ANK007

### FLOOR FASTENING

Anchoring plate (screws not included)

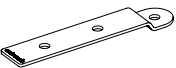
	Stainless steel 1 set: 3 pieces	<b>€ 150/set</b> ANK015
---	------------------------------------	----------------------------

### CONNECTION PIECE

To combine with Inumbrina medium

	Galvanized steel	<b>€ 120</b> ANK331
---	------------------	------------------------

# Bistroo

© design by Dirk Wynants

Bistroo is an innovative, practical, weatherproof two-seater dining set. The clever three-legged design makes it perfectly stable on any surface, and, what is more, it is easier to stack and lock away than individual tables and chairs. Structured, powder coated metals are combined with clever features and accessories. Bistroo is ideally suited for small spaces and feels right at home against the backdrop of a cozy, compact restaurant or on a small city balcony.



Check availability  
[www.extremis.com/portal](http://www.extremis.com/portal)



Charging module  
 → p178



Cushions → p31  
 Accessories → p31

Outer dimensions (l x w x h): 116 x 94 x 88 cm

Purse hanger & stacking spacer included

Structured powder coated aluminium tabletop, seats & backrests + stainless steel legs











		<b>OFF WHITE</b> RAL9002	<b>€ 1890</b> BIS408
		<b>VERDIGRIS</b> RGB 133 147 142	<b>€ 1890</b> BIS348
		<b>REED GREEN</b> RAL6013	<b>€ 1890</b> BIS349
		<b>COPPER BROWN</b> RAL8004	<b>€ 1890</b> BIS350
		<b>COSMIC CREAM</b> RAL1015	<b>€ 1890</b> BIS410
		<b>COBALT BLUE</b> RAL5013	<b>€ 2175</b> BIS352
		<b>SUN YELLOW</b> RAL1032	<b>€ 2175</b> BIS409
		<b>PISTACHE</b> RAL6021	<b>€ 2175</b> BIS407
		<b>COLOR ON REQUEST</b> Only RAL colors Startup fee € 300 (ex. VAT)	<b>€ 2175</b> BIS355

## CUSHIONS

Outer dimensions (ø x h): 34 x 1,5 cm - 1 piece

Please store the cushions inside when not in use

\* Leaving the collection. Available while supplies last

		<b>GREY CHINÉ</b> Sunbrella® Natté	<b>€ 100</b> VRS757
		<b>DARK TAUPE</b> Sunbrella® Natté	<b>€ 100</b> VRS758
		<b>MARBLE</b> Sunbrella® Lopi	<b>€ 120</b>  VRS756
		<b>CHARCOAL</b> Sunbrella® Lopi	<b>€ 120</b> VRS755
		<b>LEAF GREEN</b> Sunbrella® Heritage	<b>€ 100</b> VRS761
		<b>INDIGO *</b> Sunbrella® Heritage	<b>€ 100</b> VRS762
		<b>LOTO *</b> Sunbrella® Domino	<b>€ 120</b> VRS760
		<b>CRAPS *</b> Sunbrella® Domino	<b>€ 120</b> VRS759

## TABLE TRAY

Outer dimensions (l x w): 24 x 21 cm

It fits seamlessly in the crevice of the tabletop

	Oiled Bamboo	<b>€ 70</b>  BIS019
---	--------------	---

## FLOOR FASTENING

Screws not included

	Stainless steel 1 set: 3 pieces	<b>€ 100/set</b> BIS024
---	------------------------------------	----------------------------

## POPULAR FABRIC COMBINATIONS

Numerous color combinations are possible

To make life easier, we have created several color combinations, carefully composed following Extremis' color concepts.

Need any help finding the right color combination?

Go check our Biomes on page 169

### Forest & Fields

*A green and rural togetherness biome*



Bistroo

**Off white**

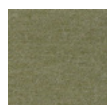

Cushions

**Leaf green**

### Forest & Fields

*A green and rural togetherness biome*



Bistroo

**Verdigris**



Cushions

**Marble**

### Forest & Fields

*A green and rural togetherness biome*



Bistroo

**Reed green**



Cushions

**Charcoal**

### A Lotta Terracotta

*A mediterranean togetherness biome*



Bistroo

**Copper brown**

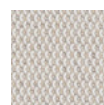

Cushions

**Marble**



## POPULAR FABRIC COMBINATIONS

Numerous color combinations are possible

To make life easier, we have created several color combinations, carefully composed following Extremis' color concepts.

Need any help finding the right color combination?

Go check our Biomes on page 169

### Out of the Fjordinary

*A boreal and montane togetherness biome*



Bistroo

Cobalt blue



Cushions

Charcoal

### Majestic Mirage

*A sandy and breezy togetherness biome*



Bistroo

Cosmic cream

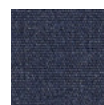

Cushions

Indigo

### Out of the Fjordinary

*A boreal and montane togetherness biome*



Bistroo

Pistache

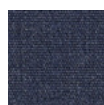

Cushions

Indigo

### Majestic Mirage

*A sandy and breezy togetherness biome*



Bistroo

Sun yellow



Cushions

Loto

# Captain's Chair

© design by Metrica

The Captain's Chair owes its name to its shape, which draws inspiration from yacht helm chairs. It's a shell chair offering unrivalled seating comfort. Thanks to this variety of frames, the chair can be used in all kinds of environments: public spaces, private homes, indoors, outdoors, etc. It is perfectly suited for terraces, patios, hotels, restaurants, pubs, offices, dining rooms, meeting rooms, bars and lounges, to name but a few possibilities.



Combine a shell + legs to compose your favorite Captain's Chair.

















Check availability  
[www.extremis.com/portal](http://www.extremis.com/portal)

## SHELL

Reinforced polypropylene shell

Legs not included, choose your legs on the next pages

\* Leaving the collection. Available while supplies last

		<b>BLACK</b> RAL9005	€ 170  CAP002
		<b>EARTH</b> RGB 88 88 84	€ 170  CAP271
		<b>BEACH BEIGE</b> RAL1019	€ 170  CAP348
		<b>OFF WHITE</b> RAL9002	€ 170  CAP347
		<b>PAPYRUS WHITE *</b> RAL9018	€ 170  CAP270
		<b>VERDIGRIS</b> RGB 133 147 142	€ 170  CAP269
		<b>REED GREEN</b> RAL6013	€ 170  CAP264



## Friends of the product

AMAI



→ p12

Hopper  
 combo (AA)



→ p48

Marina  
 combo



→ p88

Marina  
 double desk



→ p94

Marina  
 table



→ p96

Marina  
 high table



→ p98

Panigiri  
 combo & table



→ p102

Pantagruel  
 high table











→ p114

## CUSHIONS

Please store the cushions inside when not in use

\* Leaving the collection. Available while supplies last

		<b>GREY CHINÉ *</b> Sunbrella® Natté	<b>€ 150</b> CAP304
		<b>DARK TAUPE *</b> Sunbrella® Natté	<b>€ 150</b> CAP305
		<b>COCONUT</b> Sunbrella® Savane	<b>€ 150</b> CAP308
		<b>MARBLE</b> Sunbrella® Lopi	<b>€ 180</b>  CAP303
		<b>CHARCOAL</b> Sunbrella® Lopi	<b>€ 180</b> CAP302
		<b>LEAF GREEN *</b> Sunbrella® Heritage	<b>€ 150</b> CAP307
		<b>RUST *</b> Sunbrella® Heritage	<b>€ 150</b> CAP306

## QUILTED CUSHIONS







Please store the cushions inside when not in use

		<b>COCONUT</b> Sunbrella® Savane	<b>€ 325</b> CAP037
		<b>MARBLE</b> Sunbrella® Lopi	<b>€ 350</b>  CAP035
		<b>CHARCOAL</b> Sunbrella® Lopi	<b>€ 350</b> CAP036

## PIPE LEGS

Outer dimensions (l x w x h): 61 x 63 x 82 cm









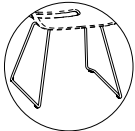

Structured powder coated stainless steel legs

		<b>BLACK</b> RAL9005	<b>€ 295</b> CAP030
		<b>EARTH</b> RGB 88 88 84	<b>€ 295</b>  CAP031
		<b>BEACH BEIGE</b> RAL1019	<b>€ 295</b> CAP032
		<b>OFF WHITE</b> RAL9002	<b>€ 295</b> CAP033

## SLIDING LEGS

Outer dimensions (l x w x h): 62 x 63 x 82 cm

Galvanized steel or Structured powder coated zinc steel legs







		<b>GALVANIZED STEEL</b>	<b>€ 215</b> CAP205
		<b>BLACK</b> RAL9005	<b>€ 230</b>  CAP230
		<b>EARTH</b> RGB 88 88 84	<b>€ 230</b> CAP276
		<b>BEACH BEIGE</b> RAL1019	<b>€ 230</b> CAP333
		<b>OFF WHITE</b> RAL9002	<b>€ 230</b>  CAP329
		<b>VERDIGRIS</b> RGB 133 147 142	<b>€ 230</b> CAP268
		<b>REED GREEN</b> RAL6013	<b>€ 230</b> CAP275
		<b>COPPER BROWN</b> RAL8004	<b>€ 230</b> CAP286

## HIGH SLIDING LEGS - BAR

Outer dimensions (l x w x h): 60 x 63 x 114 cm

Structured powder coated zinc steel legs

\* Leaving the collection. Available while supplies last

		<b>BLACK</b> RAL9005	<b>€ 335</b> CAP232
		<b>EARTH</b> RGB 88 88 84	<b>€ 335</b> CAP281
		<b>BEACH BEIGE</b> RAL1019	<b>€ 335</b> CAP048
		<b>OFF WHITE</b> RAL9002	<b>€ 335</b> CAP047
		<b>VERDIGRIS *</b> RGB 133 147 142	<b>€ 335</b> CAP279

## PROTECTION FEET WITH FELT

For delicate floors | Indoor use only



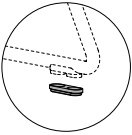

Only for Sliding, High sliding & Lounge legs

	1 set: 4 pieces	<b>€ 10/set</b> CAP245
--	-----------------	---------------------------

## LOUNGE LEGS

Outer dimensions (l x w x h): 64 x 63 x 68 cm

Structured powder coated zinc steel legs





		<b>EARTH</b> RGB 88 88 84	<b>€ 220</b>  CAP044
		<b>OFF WHITE</b> RAL9002	<b>€ 220</b> CAP038

## SIDEKICK

Outer dimensions (l x w): 29 x 21 cm - Table height: 41 cm - Width in combination with Lounge legs: 80 cm

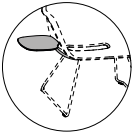
Structured powder coated zinc steel





Only compatible with the Captain's Lounge Chair legs - Can only be mounted on the right side

		<b>EARTH</b> RGB 88 88 84	<b>€ 195</b>  CAP045
		<b>OFF WHITE</b> RAL9002	<b>€ 195</b> CAP039

## FOOTREST

Outer dimensions (l x w x h): 47 x 38 x 27 cm

Structured powder coated zinc steel

		<b>EARTH</b> RGB 88 88 84	<b>€ 220</b>  CAP046
		<b>OFF WHITE</b> RAL9002	<b>€ 220</b> CAP040

## FOOTREST CUSHION

Please store the cushions inside when not in use

		<b>COCONUT</b> Sunbrella® Savane	<b>€ 100</b> CAP043
		<b>MARBLE</b> Sunbrella® Lopi	<b>€ 120</b>  CAP041
		<b>CHARCOAL</b> Sunbrella® Lopi	<b>€ 120</b> CAP042

### CAPTAIN'S LOUNGE CHAIR COMBINATION

Complete set (Off white)



CAP347 + CAP038 + CAP039 + CAP040

**€ 805**

### CAPTAIN'S LOUNGE CHAIR COMBINATION

Full option with quilted & footrest cushion

(Off white with Marble cushions)



CAP347 + CAP038 + CAP039 + CAP040  
+ CAP035 + CAP041

**€ 1275**

# Deco cushions

Combining two smaller sized deco cushions will upgrade your Extremis products. Besides adding extra comfort, they add coziness and a warm, homelike touch. Both available in a broad range of colors, that allows you to add a personal touch to your indoor or outdoor furniture setting. From a contrasting cheerful color combination to a more balanced ton-sur-ton look, whatever suits your personal style!













Check availability  
[www.extremis.com/portal](http://www.extremis.com/portal)

## LUMBAR- AND DECO CUSHIONS

Outer dimensions (l x w x t)

Please store the cushions inside when not in use

\* Leaving the collection. Available while supplies last

		 <b>LUMBAR CUSHION</b> 30 x 50 x 17 cm	 <b>DECO CUSHION</b> 50 x 50 x 17 cm
	<b>GREY CHINÉ</b> Sunbrella® Natté	€ 80 WAL440	€ 105 WAL123
	<b>DARK TAUPE</b> Sunbrella® Natté	€ 80 WAL410	€ 105 WAL122
	<b>COCONUT</b> Sunbrella® Savane	€ 80 WAL407	€ 105 WAL394
	<b>MARBLE</b> Sunbrella® Lopi	€ 100 WAL408	€ 125 WAL395
	<b>CHARCOAL</b> Sunbrella® Lopi	€ 100 WAL409	€ 125 WAL396
	<b>SOOTY *</b> Sunbrella® Chartres	/	€ 115 WAL132
	<b>LEAF GREEN</b> Sunbrella® Heritage	€ 80 WAL413	€ 105 WAL130
	<b>MOSS</b> Sunbrella® Heritage	€ 80 WAL415	€ 105 WAL400



### Friends of the product

Kosmos

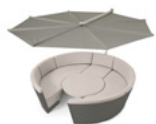

→ p76

Sol+Luna



→ p128

Walrus



→ p152





















## LUMBAR- AND DECO CUSHIONS

Outer dimensions (l x w x t)

Please store the cushions inside when not in use

\* Leaving the collection. Available while supplies last

		 <b>LUMBAR CUSHION</b> 30 x 50 x 17 cm	 <b>DECO CUSHION</b> 50 x 50 x 17 cm
	<b>ALPINE</b> Sunbrella® Heritage	<b>€ 80</b> WAL562	<b>€ 105</b> WAL569
	<b>LOTO *</b> Sunbrella® Domino	/	<b>€ 125</b>  WAL419
	<b>RUST</b> Sunbrella® Heritage	<b>€ 80</b>  WAL414	<b>€ 105</b>  WAL399
	<b>CRAPS *</b> Sunbrella® Domino	<b>€ 100</b> WAL404	/
	<b>BLUSH</b> Sunbrella® Solids	<b>€ 80</b>  WAL417	<b>€ 105</b> WAL128
	<b>BISCUIT *</b> Sunbrella® Lopi	<b>€ 100</b>  WAL564	/
	<b>COLOR ON REQUEST 1</b> Only for Sunbrella Natté, Solids, Savane & Heritage	<b>€ 105</b> WAL423	<b>€ 130</b> WAL133
	<b>COLOR ON REQUEST 2</b> Only for Sunbrella Chartres	<b>€ 115</b> WAL424	<b>€ 140</b> WAL426
	<b>COLOR ON REQUEST 3</b> Only for Sunbrella Lopi & Domino	<b>€ 125</b> WAL425	<b>€ 150</b> WAL427

# Gargantua

© design by Dirk Wynants

Gargantua is a large round outdoor picnic table that offers superior functionality. The bench height can be adjusted to suit social or family circumstances. Due to this adjustability, the benches can move when you take a seat. In the highest position the benches become a tabletop extension and provide space for 12 people.



 Check availability  
[www.extremis.com/portal](http://www.extremis.com/portal)

 Wheelchair accessible  
 → p175

 Charging module  
 → p178

 ø65 mm





Outer dimensions (ø x h): 231 x 75 cm

	<p><b>STANDARD</b>                  Iroko hardwood                  &amp; Galvanized steel legs</p>	<p>€ 5185                   GAR001</p>
--	---	---

## CUSHIONS

1 set: 4 pieces

Please store the cushions inside when not in use

		<p><b>GREY CHINÉ</b>                  Sunbrella® Natté</p>	<p>€ 940/set                  GAR133</p>
		<p><b>MARBLE</b>                  Sunbrella® Lopi</p>	<p>€ 1165/set                  GAR135</p>
		<p><b>COLOR ON REQUEST 1</b>                  Only for Sunbrella Natté, Solids, Savane &amp; Heritage</p>	<p>€ 965/set                  GAR031</p>
		<p><b>COLOR ON REQUEST 2</b>                  Only for Sunbrella Chartres</p>	<p>€ 1080/set                  GAR137</p>
		<p><b>COLOR ON REQUEST 3</b>                  Only for Sunbrella Lopi &amp; Domino</p>	<p>€ 1190/set                  GAR138</p>

## BACKRESTS

1 set: 2 pieces

	<p>Galvanized steel</p>	<p>€ 730/set                  GAR038</p>
--	-------------------------	--



### Friends of the product

Inumbra  
 medium / large

→ p68



Inumbra  
 large

→ p72



## FLOOR FASTENING

Anchoring plate (screws not included)

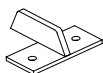

Galvanized steel  
1 set: 4 pieces

€ 150/set  
GAR049

## BENCH FASTENING

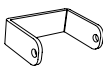

Galvanized steel  
1 set: 4 pieces

€ 135/set  
GAR092

## CONNECTION OPTIONS

To combine with Inumbra or Inumbrina



**CONNECTION PIECE INUMBRA**  
Inumbra medium - large

€ 250   
INU007



**CONNECTION PIECE INUMBRINA**  
Inumbrina large  
Inner ø5 cm

€ 190  
INI010

## GARGANTUA COMBINATION

With Inumbrina large (+ connection piece)



GAR001 + INI001 + INI010

€ 8370

## GARGANTUA COMBINATION

With Inumbra large (+ connection piece), cushions (Marble) & backrests



GAR001 + GAR135 + GAR038  
+ INU004 + INU007

€ 11640

# Hopper bench

© design by Dirk Wynants

In streetscapes and squares, gardens or balconies, Hopper bench suits any location. This multi-functional design can be used in more ways than a traditional city bench. The attached legs allow you to slide in from the sides and sit down with a backrest. And the top surface doubles as a tabletop when facing the opposite direction. The versatility of this design allows for a quick change of scenery while adding comfort along the way. If you prefer a mono-material bench, you can opt for Hopper bench AA, our All Aluminium version.



Check availability  
www.extremis.com/portal



Wheelchair accessible  
→ p173













## HOPPER BENCH 240

Outer dimensions (l x w x h): 238 x 68 x 74 cm - 3 people

Galvanized steel or Structured powder coated aluminium legs | Hellwood = 100% PEFC

The wooden Hopper benches are always with a galvanized steel frame

Always with two anchoring holes ø 1,2 cm

		 <b>AA</b> <i>All aluminium tabletop &amp; bench</i>	 <b>HELLWOOD</b> <i>Thermally treated wood tabletop &amp; bench</i>	 <b>IROKO</b> <i>Tropical hardwood tabletop &amp; bench</i>
	<b>GALVANIZED STEEL</b>	/	<b>€ 2760</b> HOW353	<b>€ 2950</b> HOW357
	<b>BLACK</b> RAL9005	<b>€ 3025</b> HOA382	<b>€ 3025</b> HOW512	<b>€ 3215</b> HOW520
	<b>EARTH</b> RGB 88 88 84	<b>€ 3025</b> HOA377	<b>€ 3025</b> HOW508	<b>€ 3215</b> HOW514
	<b>BEACH BEIGE</b> RAL1019	<b>€ 3025</b> HOA535	<b>€ 3025</b> HOW569	<b>€ 3215</b> HOW566
	<b>OFF WHITE</b> RAL9002	<b>€ 3025</b> HOA534	<b>€ 3025</b> HOW568	<b>€ 3215</b> HOW565
	<b>VERDIGRIS</b> RGB 133 147 142	<b>€ 3025</b> HOA380	<b>€ 3025</b> HOW510	<b>€ 3215</b> HOW518
	<b>REED GREEN</b> RAL6013	<b>€ 3025</b> HOA379	<b>€ 3025</b> HOW513	<b>€ 3215</b> HOW517
	<b>COPPER BROWN</b> RAL8004	<b>€ 3025</b> HOA536	<b>€ 3025</b> HOW570	<b>€ 3215</b> HOW567
	<b>COLOR ON REQUEST</b> Only RAL colors Startup fee € 300 (ex. VAT)	<b>€ 3480</b> HOA378	<b>€ 3250</b> HOW354	<b>€ 3440</b> HOW358



## HOPPER BENCH 300

Outer dimensions (l x w x h): 298 x 68 x 74 cm - 4 people

Galvanized steel or Structured powder coated aluminium legs | Hellwood = 100% PEFC

The wooden Hopper benches are always with a galvanized steel frame

Always with two anchoring holes ø 1,2 cm

	<b>AA</b> <i>All aluminium tabletop &amp; bench</i>	<b>HELLWOOD</b> <i>Thermally treated wood tabletop &amp; bench</i>	<b>IROKO</b> <i>Tropical hardwood tabletop &amp; bench</i>	
	<b>GALVANIZED STEEL</b>	/	<b>€ 3200</b> HOW355	<b>€ 3420</b> HOW359
	<b>BLACK</b> RAL9005	<b>€ 3465</b> HOA388	<b>€ 3465</b> HOW525	<b>€ 3685</b> HOW531
	<b>EARTH</b> RGB 88 88 84	<b>€ 3465</b> HOA383	<b>€ 3465</b> HOW521	<b>€ 3685</b> HOW532
	<b>BEACH BEIGE</b> RAL1019	<b>€ 3465</b> HOA548	<b>€ 3465</b> HOW575	<b>€ 3685</b> HOW572
	<b>OFF WHITE</b> RAL9002	<b>€ 3465</b> HOA547	<b>€ 3465</b> HOW574	<b>€ 3685</b> HOW571
	<b>VERDIGRIS</b> RGB 133 147 142	<b>€ 3465</b> HOA386	<b>€ 3465</b> HOW523	<b>€ 3685</b> HOW529
	<b>REED GREEN</b> RAL6013	<b>€ 3465</b> HOA385	<b>€ 3465</b> HOW526	<b>€ 3685</b> HOW528
	<b>COPPER BROWN</b> RAL8004	<b>€ 3465</b> HOA549	<b>€ 3465</b> HOW576	<b>€ 3685</b> HOW573
	<b>COLOR ON REQUEST</b> Only RAL colors Startup fee € 300 (ex. VAT)	<b>€ 3980</b> HOA384	<b>€ 3690</b> HOW356	<b>€ 3910</b> HOW360









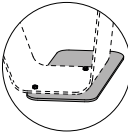

## STABILIZING SUPPORT

Outer dimensions (l x w x h): 52 x 26 x 0,8 cm

Galvanized steel or Structured powder coated zinc steel base plates

Not necessary when anchored to the floor

1 set: 2 pieces

		<b>GALVANIZED STEEL</b>	<b>€ 245/set</b> HOP105
		<b>BLACK</b> RAL9005	<b>€ 395/set</b> HOA371
		<b>EARTH</b> RGB 88 88 84	<b>€ 395/set</b> HOA372
		<b>BEACH BEIGE</b> RAL1019	<b>€ 395/set</b> HOA551
		<b>OFF WHITE</b> RAL9002	<b>€ 395/set</b> HOA550
		<b>VERDIGRIS</b> RGB 133 147 142	<b>€ 395/set</b> HOA373
		<b>REED GREEN</b> RAL6013	<b>€ 395/set</b> HOA374
		<b>COPPER BROWN</b> RAL8004	<b>€ 395/set</b> HOA552
		<b>COLOR ON REQUEST</b> Only RAL colors Startup fee € 300 (ex. VAT)	<b>€ 415/set</b> HOA376

## HOPPER BENCH APPLICATIONS

Where to place the Hopper bench?

Against a wall or balustrade

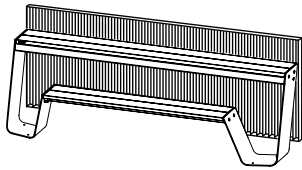

Freestanding, always anchored to the floor

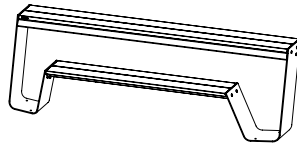

Freestanding with stabilizing support

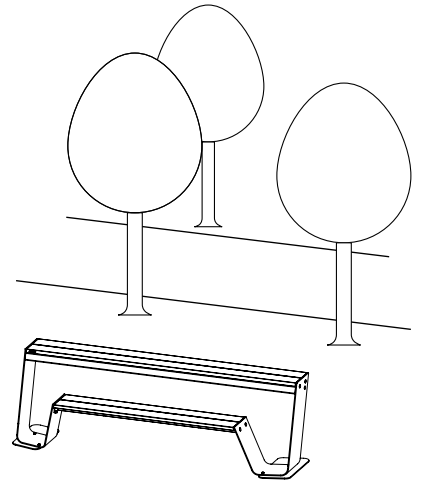



# Hopper combo 180

© design by Dirk Wynants

The Hopper combo combines the best of two worlds: a bench on one side and chairs on the other. Grab a few Captain's Chairs to add comfort. The attached benches allow you to slide in from the sides, without having to lift your legs. The open side offers flexibility and welcomes wheelchairs or child seats at any time.



 Check availability  
www.extremis.com/portal











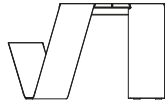

 Wheelchair accessible  
→ p173

 Charging module  
→ p178

 Cushions → p60  
Backrest → p62

## STANDARD LEGS

Outer dimensions (l x w x h): 178 x 123 x 74 cm - 4 people | Possible to fit 2 Captain's Chairs  
Structured powder coated aluminium legs | Hellwood = 100% PEFC  
Supported by a galvanized steel frame

	  <b>HELLWOOD</b> <i>Thermally treated wood tabletop &amp; bench</i>	 <b>IROKO</b> <i>Tropical hardwood tabletop &amp; bench</i>	
	<b>BLACK</b> RAL9005	<b>€ 4675</b> HOW129	<b>€ 4965</b> HOW157
	<b>EARTH</b> RGB 88 88 84	<b>€ 4675</b> HOW131	<b>€ 4965</b> HOW159
	<b>BEACH BEIGE</b> RAL1019	<b>€ 4675</b> HOW581	<b>€ 4965</b> HOW578
	<b>OFF WHITE</b> RAL9002	<b>€ 4675</b> HOW580	<b>€ 4965</b> HOW577
	<b>VERDIGRIS</b> RGB 133 147 142	<b>€ 4675</b> HOW134	<b>€ 4965</b> HOW162
	<b>REED GREEN</b> RAL6013	<b>€ 4675</b> HOW133	<b>€ 4965</b> HOW161
	<b>COPPER BROWN</b> RAL8004	<b>€ 4675</b> HOW582	<b>€ 4965</b> HOW579
	<b>COLOR ON REQUEST</b> Only RAL colors Startup fee € 300 (ex. VAT)	<b>€ 5020</b> HOW135	<b>€ 5310</b> HOW163



## Friends of the product

Captain's Chairs



→ p34

Sensu



→ p118



# Hopper combo 240

© design by Dirk Wynants

The Hopper combo combines the best of two worlds: a bench on one side and chairs on the other. Grab a few Captain's Chairs to add comfort. The attached benches allow you to slide in from the sides, without having to lift your legs. The open side offers flexibility and welcomes wheelchairs or child seats at any time. If you prefer a mono-material table, you can opt for Hopper AA, our All Aluminium version.



Check availability  
www.extremis.com/portal



Wheelchair accessible  
→ p173



Charging module  
→ p178

















Cushions → p60  
Backrest → p63

## STANDARD LEGS

Outer dimensions (l x w x h): 238 x 123 x 74 cm - 6 people | Possible to fit 3 Captain's Chairs

Structured powder coated aluminium legs | Hellwood = 100% PEFC

The wooden Hopper combo has a galvanized steel frame

		 <b>AA</b> <i>All aluminium tabletop &amp; bench</i>	  <b>HELLWOOD</b> <i>Thermally treated wood tabletop &amp; bench</i>	 <b>IROKO</b> <i>Tropical hardwood tabletop &amp; bench</i>
	<b>BLACK</b> RAL9005	€ 5390 HOA356	€ 5390  HOW136	€ 5740 HOW164
	<b>EARTH</b> RGB 88 88 84	€ 5390 HOA357	€ 5390 HOW138	€ 5740 HOW166
	<b>BEACH BEIGE</b> RAL1019	€ 5390 HOA568	€ 5390 HOW587	€ 5740 HOW584
	<b>OFF WHITE</b> RAL9002	€ 5390 HOA567	€ 5390  HOW586	€ 5740 HOW583
	<b>VERDIGRIS</b> RGB 133 147 142	€ 5390 HOA358	€ 5390 HOW141	€ 5740 HOW169
	<b>REED GREEN</b> RAL6013	€ 5390 HOA359	€ 5390 HOW140	€ 5740 HOW168
	<b>COPPER BROWN</b> RAL8004	€ 5390 HOA569	€ 5390 HOW588	€ 5740 HOW585
	<b>COLOR ON REQUEST</b> Only RAL colors Startup fee € 300 (ex. VAT)	€ 6205 HOA360	€ 5735 HOW142	€ 6085 HOW170



## Friends of the product

Captain's Chairs

→ p34



Sensu

→ p118





# Hopper combo 300

© design by Dirk Wynants

The Hopper combo combines the best of two worlds: a bench on one side and chairs on the other. Grab a few Captain's Chairs to add comfort. The attached benches allow you to slide in from the sides, without having to lift your legs. The open side offers flexibility and welcomes wheelchairs or child seats at any time. If you prefer a mono-material table, you can opt for Hopper AA, our All Aluminium version.



 Check availability  
www.extremis.com/portal

 Wheelchair accessible  
→ p173

 Charging module  
→ p178











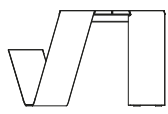



 Cushions → p60  
Backrest → p64

## STANDARD LEGS

Outer dimensions (l x w x h): 298 x 123 x 74 cm - 8 people | Possible to fit 4 Captain's Chairs

Structured powder coated aluminium legs | Hellwood = 100% PEFC

The wooden Hopper combo has a galvanized steel frame

	 <b>AA</b> <i>All aluminium tabletop &amp; bench</i>	 <b>HELLWOOD</b> <i>Thermally treated wood tabletop &amp; bench</i>	 <b>IROKO</b> <i>Tropical hardwood tabletop &amp; bench</i>
	<b>BLACK</b> RAL9005 € 6155 HOA362	€ 6155  HOW143	€ 6545 HOW171
	<b>EARTH</b> RGB 88 88 84 € 6155 HOA363	€ 6155 HOW145	€ 6545 HOW173
	<b>BEACH BEIGE</b> RAL1019 € 6155 HOA578	€ 6155 HOW593	€ 6545 HOW590
	<b>OFF WHITE</b> RAL9002 € 6155 HOA577	€ 6155  HOW592	€ 6545 HOW589
	<b>VERDIGRIS</b> RGB 133 147 142 € 6155 HOA316	€ 6155 HOW148	€ 6545 HOW176
	<b>REED GREEN</b> RAL6013 € 6155 HOA314	€ 6155 HOW147	€ 6545 HOW175
	<b>COPPER BROWN</b> RAL8004 € 6155 HOA579	€ 6155 HOW594	€ 6545 HOW591
	<b>COLOR ON REQUEST</b> Only RAL colors Startup fee € 300 (ex. VAT) € 7080 HOA364	€ 6500 HOW149	€ 6890 HOW177



## Friends of the product

Captain's Chairs



→ p34

Sensu



→ p118

# Hopper combo 360

© design by Dirk Wynants



The Hopper combo combines the best of two worlds: a bench on one side and chairs on the other. Grab a few Captain's Chairs to add comfort. The attached benches allow you to slide in from the sides, without having to lift your legs. The open side offers flexibility and welcomes wheelchairs or child seats at any time. If you prefer a mono-material table, you can opt for Hopper AA, our All Aluminium version.



Check availability  
www.extremis.com/portal



Wheelchair accessible  
→ p173



Charging module  
→ p178















Cushions → p60  
Backrest → p65

## STANDARD LEGS

Outer dimensions (l x w x h): 358 x 123 x 74 cm - 10 people | Possible to fit 5 Captain's Chairs

Structured powder coated aluminium legs | Hellwood = 100% PEFC

The wooden Hopper combo has a galvanized steel frame

		 <b>AA</b> <i>All aluminium tabletop &amp; bench</i>	  <b>HELLWOOD</b> <i>Thermally treated wood tabletop &amp; bench</i>	 <b>IROKO</b> <i>Tropical hardwood tabletop &amp; bench</i>
	<b>BLACK</b> RAL9005	€ 6965 HOA366	€ 6965 HOW150	€ 7390 HOW178
	<b>EARTH</b> RGB 88 88 84	€ 6965 HOA367	€ 6965 HOW152	€ 7390 HOW180
	<b>BEACH BEIGE</b> RAL1019	€ 6965 HOA592	€ 6965 HOW599	€ 7390 HOW596
	<b>OFF WHITE</b> RAL9002	€ 6965 HOA591	€ 6965 HOW598	€ 7390 HOW595
	<b>VERDIGRIS</b> RGB 133 147 142	€ 6965 HOA368	€ 6965 HOW155	€ 7390 HOW183
	<b>REED GREEN</b> RAL6013	€ 6965 HOA369	€ 6965 HOW154	€ 7390 HOW182
	<b>COPPER BROWN</b> RAL8004	€ 6965 HOA593	€ 6965 HOW600	€ 7390 HOW597
	<b>COLOR ON REQUEST</b> Only RAL colors Startup fee € 300 (ex. VAT)	€ 8015 HOA370	€ 7310 HOW156	€ 7735 HOW184



## Friends of the product

Captain's Chairs

→ p34



Sensu

→ p118



# Hopper picnic 180

© design by Dirk Wynants

Hopper is a more functional solution for a classic concept: the picnic table. The bent leg feature eliminates the awkward straddle of climbing over the benches. Aluminium or steel legs in combination with class I hardwoods ensure material longevity while the attached benches offer a clean aesthetic at all times.



Check availability  
[www.extremis.com/portal](http://www.extremis.com/portal)



Charging module  
→ p178



Legs options → p53  
Cushions → p60  
Backrest → p62

## STANDARD LEGS

Outer dimensions (l x w x h): 178 x 160 x 74 cm - 4 people

Galvanized steel or Structured powder coated aluminium legs | Hellwood = 100% PEFC

Supported by a galvanized steel frame

	 <b>HELLWOOD</b> <i>Thermally treated wood tabletop &amp; benches</i>	 <b>IROKO</b> <i>Tropical hardwood tabletop &amp; benches</i>	
	<b>GALVANIZED STEEL</b> Legs	<b>€ 4755</b> HOW004	<b>€ 5100</b> HOW036
	<b>GALVANIZED STEEL WITH ANCHORING HOLES</b> 2 holes per leg: ø 1,2 cm	<b>€ 4865</b> HOW005	<b>€ 5210</b> HOW037
	<b>BLACK</b> RAL9005	<b>€ 5345</b> HOW001	<b>€ 5690</b> HOW033
	<b>EARTH</b> RGB 88 88 84	<b>€ 5345</b> HOW003	<b>€ 5690</b> HOW035
	<b>BEACH BEIGE</b> RAL1019	<b>€ 5345</b> HOW605	<b>€ 5690</b> HOW602
	<b>OFF WHITE</b> RAL9002	<b>€ 5345</b> HOW604	<b>€ 5690</b> HOW601
	<b>VERDIGRIS</b> RGB 133 147 142	<b>€ 5345</b> HOW007	<b>€ 5690</b> HOW039
	<b>REED GREEN</b> RAL6013	<b>€ 5345</b> HOW006	<b>€ 5690</b> HOW038
	<b>COPPER BROWN</b> RAL8004	<b>€ 5345</b> HOW606	<b>€ 5690</b> HOW603
	<b>COLOR ON REQUEST</b> Only RAL colors Startup fee € 300 (ex. VAT)	<b>€ 5725</b> HOW015	<b>€ 6070</b> HOW040

### FLOOR FASTENING SET

Anchoring plate (screws not included)

Can not be combined with galvanized steel legs with anchoring holes

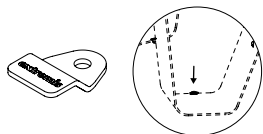

Stainless steel  
1 set: 4 pieces

**€ 140/set**  
HOP021

### PROTECTION FELT

For indoor use

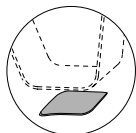

Anthracite felt  
1 set: 4 pieces

**€ 45/set**  
HOP022

# Hopper picnic 240

© design by Dirk Wynants

Hopper is a more functional solution for a classic concept: the picnic table. The bent leg feature eliminates the awkward straddle of climbing over the benches. Aluminium or steel legs in combination with class I hardwoods ensure material longevity while the attached benches offer a clean aesthetic at all times. If you prefer a mono-material picnic table, you can opt for Hopper AA, our All Aluminium version.



Check availability  
www.extremis.com/portal



Charging module  
→ p178

























Legs options → p53  
Cushions → p60  
Backrest → p63

## STANDARD LEGS

Outer dimensions (l x w x h): 238 x 160 x 74 cm - 6 people

Galvanized steel or Structured powder coated aluminium legs | Hellwood = 100% PEFC

The wooden Hopper picnic has a galvanized steel frame

	 <b>AA</b> All aluminium tabletop & benches	 <b>HELLWOOD</b> Thermally treated wood tabletop & benches	 <b>IROKO</b> Tropical hardwood tabletop & benches
 <b>GALVANIZED STEEL</b>	/	€ 5635 HOW011	€ 6020 HOW044
 <b>GALVANIZED STEEL WITH ANCHORING HOLES</b> 2 holes per leg: ø 1,2 cm	/	€ 5745 HOW012	€ 6130 HOW045
 <b>BLACK</b> RAL9005	€ 6225 HOA004	€ 6225  HOW008	€ 6610 HOW041
 <b>EARTH</b> RGB 88 88 84	€ 6225 HOA002	€ 6225  HOW010	€ 6610 HOW043
 <b>BEACH BEIGE</b> RAL1019	€ 6225 HOA597	€ 6225  HOW611	€ 6610 HOW607
 <b>OFF WHITE</b> RAL9002	€ 6225 HOA596	€ 6225  HOW610	€ 6610 HOW608
 <b>VERDIGRIS</b> RGB 133 147 142	€ 6225  HOA001	€ 6225  HOW014	€ 6610 HOW047
 <b>REED GREEN</b> RAL6013	€ 6225  HOA005	€ 6225  HOW013	€ 6610 HOW046
 <b>COPPER BROWN</b> RAL8004	€ 6225 HOA297	€ 6225  HOW612	€ 6610 HOW609
 <b>COLOR ON REQUEST</b> Only RAL colors Startup fee € 300 (ex. VAT)	€ 7160 HOA006	€ 6605 HOW016	€ 6990 HOW048











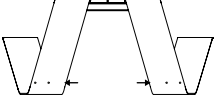



## LEGS WITH PARASOL HOLES

Outer dimensions (l x w x h): 238 x 160 x 74 cm - 6 people

Galvanized steel or Structured powder coated aluminium legs | Hellwood = 100% PEFC

The wooden Hopper picnic has a galvanized steel frame

Should always be combined with the Hopper shade connection option - assembly to Hopper legs (HSH014)

	 <p><b>AA</b> All aluminium tabletop &amp; benches</p>	 <p><b>HELLWOOD</b> Thermally treated wood tabletop &amp; benches</p>	 <p><b>IROKO</b> Tropical hardwood tabletop &amp; benches</p>
 <p><b>GALVANIZED STEEL</b></p>	/	<p>€ 5635 HOW076</p>	<p>€ 6020 HOW108</p>
 <p><b>GALVANIZED STEEL WITH ANCHORING HOLES</b> 2 holes per leg: ø 1,2 cm</p>	/	<p>€ 5890 HOW077</p>	<p>€ 6275 HOW109</p>
 <p><b>BLACK</b> RAL9005</p>	<p>€ 6225 HOA022</p>	<p>€ 6225 HOW073</p>	<p>€ 6610 HOW105</p>
 <p><b>EARTH</b> RGB 88 88 84</p>	<p>€ 6225 HOA020</p>	<p>€ 6225 HOW075</p>	<p>€ 6610 HOW107</p>
 <p><b>BEACH BEIGE</b> RAL1019</p>	<p>€ 6225 HOA599</p>	<p>€ 6225 HOW617</p>	<p>€ 6610 HOW614</p>
 <p><b>OFF WHITE</b> RAL9002</p>	<p>€ 6225 HOA598</p>	<p>€ 6225 HOW616</p>	<p>€ 6610 HOW613</p>
 <p><b>VERDIGRIS</b> RGB 133 147 142</p>	<p>€ 6225 HOA019</p>	<p>€ 6225 HOW079</p>	<p>€ 6610 HOW111</p>
 <p><b>REED GREEN</b> RAL6013</p>	<p>€ 6225 HOA023</p>	<p>€ 6225 HOW078</p>	<p>€ 6610 HOW110</p>
 <p><b>COPPER BROWN</b> RAL8004</p>	<p>€ 6225 HOA600</p>	<p>€ 6225 HOW618</p>	<p>€ 6610 HOW615</p>
 <p><b>COLOR ON REQUEST</b> Only RAL colors Startup fee € 300 (ex. VAT)</p>	<p>€ 7160 HOA024</p>	<p>€ 6605 HOW080</p>	<p>€ 6990 HOW112</p>



### Friends of the product

Hopper shade

→ p66





# Hopper picnic 300

© design by Dirk Wynants

Hopper is a more functional solution for a classic concept: the picnic table. The bent leg feature eliminates the awkward straddle of climbing over the benches. Aluminium or steel legs in combination with class I hardwoods ensure material longevity while the attached benches offer a clean aesthetic at all times. If you prefer a mono-material picnic table, you can opt for Hopper AA, our All Aluminium version.



 Check availability  
www.extremis.com/portal

 Wheelchair accessible  
→ p177

 Charging module  
→ p178











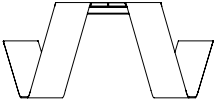













 Legs options → p53  
Cushions → p60  
Backrest → p64

## STANDARD LEGS

Outer dimensions (l x w x h): 298 x 160 x 74 cm - 8 people

Galvanized steel or Structured powder coated aluminium legs | Hellwood = 100% PEFC

The wooden Hopper picnic has a galvanized steel frame

	 <b>AA</b> All aluminium tabletop & benches	  <b>HELLWOOD</b> Thermally treated wood tabletop & benches	 <b>IROKO</b> Tropical hardwood tabletop & benches	
	<b>GALVANIZED STEEL</b>	/	<b>€ 6505</b> HOW020	<b>€ 6945</b> HOW052
	<b>GALVANIZED STEEL WITH ANCHORING HOLES</b> 2 holes per leg: ø 1,2 cm	/	<b>€ 6615</b> HOW021	<b>€ 7055</b> HOW053
	<b>BLACK</b> RAL9005	<b>€ 7095</b> HOA010	<b>€ 7095</b>  HOW017	<b>€ 7535</b> HOW049
	<b>EARTH</b> RGB 88 88 84	<b>€ 7095</b> HOA008	<b>€ 7095</b>  HOW019	<b>€ 7535</b> HOW051
	<b>BEACH BEIGE</b> RAL1019	<b>€ 7095</b> HOA602	<b>€ 7095</b>  HOW622	<b>€ 7535</b> HOW564
	<b>OFF WHITE</b> RAL9002	<b>€ 7095</b> HOA601	<b>€ 7095</b>  HOW621	<b>€ 7535</b> HOW619
	<b>VERDIGRIS</b> RGB 133 147 142	<b>€ 7095</b>  HOA007	<b>€ 7095</b>  HOW023	<b>€ 7535</b> HOW055
	<b>REED GREEN</b> RAL6013	<b>€ 7095</b>  HOA011	<b>€ 7095</b>  HOW022	<b>€ 7535</b> HOW054
	<b>COPPER BROWN</b> RAL8004	<b>€ 7095</b> HOA513	<b>€ 7095</b>  HOW620	<b>€ 7535</b> HOW553
	<b>COLOR ON REQUEST</b> Only RAL colors Startup fee € 300 (ex. VAT)	<b>€ 8160</b> HOA012	<b>€ 7475</b> HOW024	<b>€ 7915</b> HOW056













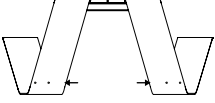



## LEGS WITH PARASOL HOLES

Outer dimensions (l x w x h): 298 x 160 x 74 cm - 8 people

Galvanized steel or Structured powder coated aluminium legs | Hellwood = 100% PEFC

The wooden Hopper picnic has a galvanized steel frame

Should always be combined with the Hopper shade connection option - assembly to Hopper legs (HSH014)

	 <p><b>AA</b> All aluminium tabletop &amp; benches</p>	 <p><b>HELLWOOD</b> Thermally treated wood tabletop &amp; benches</p>	 <p><b>IROKO</b> Tropical hardwood tabletop &amp; benches</p>
 <p><b>GALVANIZED STEEL</b></p>	/	<p><b>€ 6505</b> HOW084</p>	<p><b>€ 6945</b> HOW116</p>
 <p><b>GALVANIZED STEEL WITH ANCHORING HOLES</b> 2 holes per leg: ø 1,2 cm</p>	/	<p><b>€ 6760</b> HOW085</p>	<p><b>€ 7200</b> HOW117</p>
 <p><b>BLACK</b> RAL9005</p>	<p><b>€ 7095</b> HOA028</p>	<p><b>€ 7095</b> HOW081</p>	<p><b>€ 7535</b> HOW113</p>
 <p><b>EARTH</b> RGB 88 88 84</p>	<p><b>€ 7095</b> HOA026</p>	<p><b>€ 7095</b> HOW083</p>	<p><b>€ 7535</b> HOW115</p>
 <p><b>BEACH BEIGE</b> RAL1019</p>	<p><b>€ 7095</b> HOA606</p>	<p><b>€ 7095</b> HOW627</p>	<p><b>€ 7535</b> HOW624</p>
 <p><b>OFF WHITE</b> RAL9002</p>	<p><b>€ 7095</b> HOA605</p>	<p><b>€ 7095</b> HOW626</p>	<p><b>€ 7535</b> HOW623</p>
 <p><b>VERDIGRIS</b> RGB 133 147 142</p>	<p><b>€ 7095</b> HOA025</p>	<p><b>€ 7095</b> HOW087</p>	<p><b>€ 7535</b> HOW119</p>
 <p><b>REED GREEN</b> RAL6013</p>	<p><b>€ 7095</b> HOA029</p>	<p><b>€ 7095</b> HOW086</p>	<p><b>€ 7535</b> HOW118</p>
 <p><b>COPPER BROWN</b> RAL8004</p>	<p><b>€ 7095</b> HOA607</p>	<p><b>€ 7095</b> HOW628</p>	<p><b>€ 7535</b> HOW625</p>
 <p><b>COLOR ON REQUEST</b> Only RAL colors Startup fee € 300 (ex. VAT)</p>	<p><b>€ 8160</b> HOA030</p>	<p><b>€ 7475</b> HOW088</p>	<p><b>€ 7915</b> HOW120</p>



### Friends of the product

Hopper shade

→ p66





# Hopper picnic 360

© design by Dirk Wynants

Hopper is a more functional solution for a classic concept: the picnic table. The bent leg feature eliminates the awkward straddle of climbing over the benches. Aluminium or steel legs in combination with class I hardwoods ensure material longevity while the attached benches offer a clean aesthetic at all times. If you prefer a mono-material picnic table, you can opt for Hopper AA, our All Aluminium version.



 Check availability  
www.extremis.com/portal

 Wheelchair accessible  
→ p177

 Charging module  
→ p178











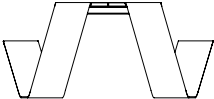



 Legs options → p53  
Cushions → p60  
Backrest → p65

## STANDARD LEGS

Outer dimensions (l x w x h): 358 x 160 x 74 cm - 10 people

Galvanized steel or Structured powder coated aluminium legs | Hellwood = 100% PEFC

The wooden Hopper picnic has a galvanized steel frame

	 <b>AA</b> All aluminium tabletop & benches	 <b>HELLWOOD</b> Thermally treated wood tabletop & benches	 <b>IROKO</b> Tropical hardwood tabletop & benches	
	<b>GALVANIZED STEEL</b>	/	<b>€ 7530</b> HOW028	<b>€ 8025</b> HOW060
	<b>GALVANIZED STEEL WITH ANCHORING HOLES</b> 2 holes per leg: ø 1,2 cm	/	<b>€ 7640</b> HOW029	<b>€ 8135</b> HOW061
	<b>BLACK</b> RAL9005	<b>€ 8120</b> HOA016	<b>€ 8120</b> HOW025	<b>€ 8615</b> HOW057
	<b>EARTH</b> RGB 88 88 84	<b>€ 8120</b> HOA014	<b>€ 8120</b> HOW027	<b>€ 8615</b> HOW059
	<b>BEACH BEIGE</b> RAL1019	<b>€ 8120</b> HOA609	<b>€ 8120</b> HOW633	<b>€ 8615</b> HOW630
	<b>OFF WHITE</b> RAL9002	<b>€ 8120</b> HOA608	<b>€ 8120</b> HOW632	<b>€ 8615</b> HOW629
	<b>VERDIGRIS</b> RGB 133 147 142	<b>€ 8120</b> HOA013	<b>€ 8120</b> HOW031	<b>€ 8615</b> HOW063
	<b>REED GREEN</b> RAL6013	<b>€ 8120</b> HOA017	<b>€ 8120</b> HOW030	<b>€ 8615</b> HOW062
	<b>COPPER BROWN</b> RAL8004	<b>€ 8120</b> HOA610	<b>€ 8120</b> HOW634	<b>€ 8615</b> HOW631
	<b>COLOR ON REQUEST</b> Only RAL colors Startup fee € 300 (ex. VAT)	<b>€ 9340</b> HOA018	<b>€ 8500</b> HOW032	<b>€ 8995</b> HOW064











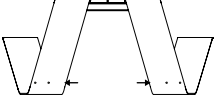



## LEGS WITH PARASOL HOLES

Outer dimensions (l x w x h): 358 x 160 x 74 cm - 10 people

Galvanized steel or Structured powder coated aluminium legs | Hellwood = 100% PEFC

The wooden Hopper picnic has a galvanized steel frame

Should always be combined with the Hopper shade connection option - assembly to Hopper legs (HSH014)

	 <p><b>AA</b> All aluminium tabletop &amp; benches</p>	 <p><b>HELLWOOD</b> Thermally treated wood tabletop &amp; benches</p>	 <p><b>IROKO</b> Tropical hardwood tabletop &amp; benches</p>
 <p><b>GALVANIZED STEEL</b></p>	/	<p><b>€ 7530</b> HOW092</p>	<p><b>€ 8025</b> HOW124</p>
 <p><b>GALVANIZED STEEL WITH ANCHORING HOLES</b> 2 holes per leg: ø 1,2 cm</p>	/	<p><b>€ 7785</b> HOW093</p>	<p><b>€ 8280</b> HOW125</p>
 <p><b>BLACK</b> RAL9005</p>	<p><b>€ 8120</b> HOA034</p>	<p><b>€ 8120</b> HOW089</p>	<p><b>€ 8615</b> HOW121</p>
 <p><b>EARTH</b> RGB 88 88 84</p>	<p><b>€ 8120</b> HOA032</p>	<p><b>€ 8120</b> HOW091</p>	<p><b>€ 8615</b> HOW123</p>
 <p><b>BEACH BEIGE</b> RAL1019</p>	<p><b>€ 8120</b> HOA614</p>	<p><b>€ 8120</b> HOW639</p>	<p><b>€ 8615</b> HOW636</p>
 <p><b>OFF WHITE</b> RAL9002</p>	<p><b>€ 8120</b> HOA613</p>	<p><b>€ 8120</b> HOW638</p>	<p><b>€ 8615</b> HOW635</p>
 <p><b>VERDIGRIS</b> RGB 133 147 142</p>	<p><b>€ 8120</b> HOA031</p>	<p><b>€ 8120</b> HOW095</p>	<p><b>€ 8615</b> HOW127</p>
 <p><b>REED GREEN</b> RAL6013</p>	<p><b>€ 8120</b> HOA035</p>	<p><b>€ 8120</b> HOW094</p>	<p><b>€ 8615</b> HOW126</p>
 <p><b>COPPER BROWN</b> RAL8004</p>	<p><b>€ 8120</b> HOA615</p>	<p><b>€ 8120</b> HOW640</p>	<p><b>€ 8615</b> HOW637</p>
 <p><b>COLOR ON REQUEST</b> Only RAL colors Startup fee € 300 (ex. VAT)</p>	<p><b>€ 9340</b> HOA036</p>	<p><b>€ 8500</b> HOW096</p>	<p><b>€ 8995</b> HOW128</p>



### Friends of the product

Hopper shade

→ p66













## CUSHIONS

Outer dimensions (l x w x t) - 1 piece

You need 1 piece for every bench

Please store the cushions inside when not in use

		<b>180</b> <i>For Hopper 180</i> <i>97 x 27 x 3 cm</i>	<b>240</b> <i>For Hopper 240</i> <i>157 x 27 x 3 cm</i>	<b>300</b> <i>For Hopper 300</i> <i>217 x 27 x 3 cm</i>	<b>360</b> <i>For Hopper 360</i> <i>277 x 27 x 3 cm</i>
	<b>GREY CHINÉ</b> Sunbrella® Natté	€ 295 HOP942	€ 360 HOP943	€ 480 HOP658	€ 595 HOP944
	<b>DARK TAUPE</b> Sunbrella® Natté	€ 295 HOP945	€ 360 HOP758	€ 480 HOP643	€ 595 HOP657
	<b>COCONUT</b> Sunbrella® Savane	€ 295 HOP970	€ 360 HOP974	€ 480 HOP941	€ 595 HOP935
	<b>MARBLE</b> Sunbrella® Lopi	€ 340 HOP946	€ 455  HOP928	€ 585  HOP947	€ 695 HOP948
	<b>CHARCOAL</b> Sunbrella® Lopi	€ 340 HOP949	€ 455 HOP950	€ 585 HOP951	€ 695 HOP952
	<b>LEAF GREEN</b> Sunbrella® Heritage	€ 295 HOP953	€ 360 HOP954	€ 480 HOP955	€ 595 HOP956
	<b>RUST</b> Sunbrella® Heritage	€ 295 HOP957	€ 360 HOP958	€ 480 HOP959	€ 595 HOP960





## CUSHIONS

Outer dimensions (l x w x t) - 1 piece

You need 1 piece for every bench

Please store the cushions inside when not in use













	<b>180</b> <i>For Hopper 180</i> 97 x 27 x 3 cm	<b>240</b> <i>For Hopper 240</i> 157 x 27 x 3 cm	<b>300</b> <i>For Hopper 300</i> 217 x 27 x 3 cm	<b>360</b> <i>For Hopper 360</i> 277 x 27 x 3 cm
 <p><b>COLOR ON REQUEST 1</b> Only for Sunbrella Natté, Solids, Savane &amp; Heritage</p>	<b>€ 320</b> HOP961	<b>€ 385</b> HOP964	<b>€ 505</b> HOP967	<b>€ 620</b> HOP971
 <p><b>COLOR ON REQUEST 2</b> Only for Sunbrella Chartres</p>	<b>€ 345</b> HOP962	<b>€ 430</b> HOP965	<b>€ 560</b> HOP968	<b>€ 670</b> HOP972
 <p><b>COLOR ON REQUEST 3</b> Only for Sunbrella Lopi &amp; Domino</p>	<b>€ 365</b> HOP963	<b>€ 485</b> HOP966	<b>€ 615</b> HOP969	<b>€ 720</b> HOP973



**BACKREST FOR HOPPER 180**

105 cm - 1 piece

Galvanized steel or Structured powder coated aluminium backrest supports | Hellwood = 100% PEFC











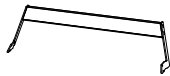



	 <b>HELLWOOD</b> <i>Thermally treated wood</i> <i>Backrest</i>	 <b>IROKO</b> <i>Tropical hardwood</i> <i>Backrest</i>
 <b>GALVANIZED STEEL</b>	<b>€ 520</b> HOW431	<b>€ 555</b> HOW424
 <b>BLACK</b> RAL9005	<b>€ 610</b> HOW432	<b>€ 645</b> HOW425
 <b>EARTH</b> RGB 88 88 84	<b>€ 610</b> HOW433	<b>€ 645</b> HOW426
 <b>BEACH BEIGE</b> RAL1019	<b>€ 610</b> HOW654	<b>€ 645</b> HOW651
 <b>OFF WHITE</b> RAL9002	<b>€ 610</b> HOW653	<b>€ 645</b> HOW650
 <b>VERDIGRIS</b> RGB 133 147 142	<b>€ 610</b> HOW435	<b>€ 645</b> HOW428
 <b>REED GREEN</b> RAL6013	<b>€ 610</b> HOW436	<b>€ 645</b> HOW429
 <b>COPPER BROWN</b> RAL8004	<b>€ 610</b> HOW655	<b>€ 645</b> HOW652
 <b>COLOR ON REQUEST</b> Only RAL colors Startup fee € 300 (ex. VAT)	<b>€ 705</b> HOW437	<b>€ 740</b> HOW430



## BACKREST FOR HOPPER 240

165 cm - 1 piece

Galvanized steel or Structured powder coated aluminium backrest supports | Hellwood = 100% PEFC











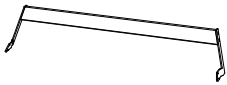



	 <p><b>AA</b> <i>All aluminium Backrest</i></p>	 <p><b>HELLWOOD</b> <i>Thermally treated wood Backrest</i></p>	 <p><b>IROKO</b> <i>Tropical hardwood Backrest</i></p>
 <p><b>GALVANIZED STEEL</b></p>	/	<p><b>€ 550</b> HOW445</p>	<p><b>€ 585</b> HOW438</p>
 <p><b>BLACK</b> RAL9005</p>	<p><b>€ 640</b> HOA318</p>	<p><b>€ 640</b>  HOW446</p>	<p><b>€ 675</b> HOW439</p>
 <p><b>EARTH</b> RGB 88 88 84</p>	<p><b>€ 640</b> HOA319</p>	<p><b>€ 640</b> HOW447</p>	<p><b>€ 675</b> HOW440</p>
 <p><b>BEACH BEIGE</b> RAL1019</p>	<p><b>€ 640</b> HOA617</p>	<p><b>€ 640</b> HOW660</p>	<p><b>€ 675</b> HOW657</p>
 <p><b>OFF WHITE</b> RAL9002</p>	<p><b>€ 640</b> HOA616</p>	<p><b>€ 640</b> HOW659</p>	<p><b>€ 675</b> HOW656</p>
 <p><b>VERDIGRIS</b> RGB 133 147 142</p>	<p><b>€ 640</b> HOA320</p>	<p><b>€ 640</b> HOW449</p>	<p><b>€ 675</b> HOW442</p>
 <p><b>REED GREEN</b> RAL6013</p>	<p><b>€ 640</b> HOA321</p>	<p><b>€ 640</b> HOW450</p>	<p><b>€ 675</b> HOW443</p>
 <p><b>COPPER BROWN</b> RAL8004</p>	<p><b>€ 640</b> HOA618</p>	<p><b>€ 640</b> HOW661</p>	<p><b>€ 675</b> HOW658</p>
 <p><b>COLOR ON REQUEST</b> Only RAL colors Startup fee € 300 (ex. VAT)</p>	<p><b>€ 735</b> HOA323</p>	<p><b>€ 735</b> HOW451</p>	<p><b>€ 770</b> HOW444</p>



## BACKREST FOR HOPPER 300

225 cm - 1 piece

Galvanized steel or Structured powder coated aluminium backrest supports | Hellwood = 100% PEFC

	 <p><b>AA</b> All aluminium Backrest</p>	  <p><b>HELLWOOD</b> Thermally treated wood Backrest</p>	 <p><b>IROKO</b> Tropical hardwood Backrest</p>
 <p><b>GALVANIZED STEEL</b></p>	/	<p><b>€ 620</b> HOW459</p>	<p><b>€ 660</b> HOW452</p>
 <p><b>BLACK</b> RAL9005</p>	<p><b>€ 710</b> HOA325</p>	<p><b>€ 710</b>  HOW460</p>	<p><b>€ 750</b> HOW453</p>
 <p><b>EARTH</b> RGB 88 88 84</p>	<p><b>€ 710</b> HOA326</p>	<p><b>€ 710</b> HOW461</p>	<p><b>€ 750</b> HOW454</p>
 <p><b>BEACH BEIGE</b> RAL1019</p>	<p><b>€ 710</b> HOA620</p>	<p><b>€ 710</b> HOW672</p>	<p><b>€ 750</b> HOW669</p>
 <p><b>OFF WHITE</b> RAL9002</p>	<p><b>€ 710</b> HOA619</p>	<p><b>€ 710</b> HOW671</p>	<p><b>€ 750</b> HOW668</p>
 <p><b>VERDIGRIS</b> RGB 133 147 142</p>	<p><b>€ 710</b> HOA327</p>	<p><b>€ 710</b> HOW480</p>	<p><b>€ 750</b> HOW456</p>
 <p><b>REED GREEN</b> RAL6013</p>	<p><b>€ 710</b> HOA328</p>	<p><b>€ 710</b> HOW463</p>	<p><b>€ 750</b> HOW457</p>
 <p><b>COPPER BROWN</b> RAL8004</p>	<p><b>€ 710</b> HOA621</p>	<p><b>€ 710</b> HOW673</p>	<p><b>€ 750</b> HOW670</p>
 <p><b>COLOR ON REQUEST</b> Only RAL colors Startup fee € 300 (ex. VAT)</p>	<p><b>€ 805</b> HOA330</p>	<p><b>€ 805</b> HOW464</p>	<p><b>€ 845</b> HOW458</p>











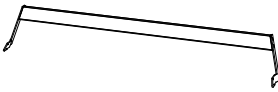





## BACKREST FOR HOPPER 360

285 cm - 1 piece

Galvanized steel or Structured powder coated aluminium backrest supports | Hellwood = 100% PEFC

	 <p><b>AA</b> <i>All aluminium Backrest</i></p>	 <p><b>HELLWOOD</b> <i>Thermally treated wood Backrest</i></p>	 <p><b>IROKO</b> <i>Tropical hardwood Backrest</i></p>
 <p><b>GALVANIZED STEEL</b></p>	/	<p><b>€ 790</b> HOW472</p>	<p><b>€ 850</b> HOW465</p>
 <p><b>BLACK</b> RAL9005</p>	<p><b>€ 880</b> HOA331</p>	<p><b>€ 880</b> HOW473</p>	<p><b>€ 940</b> HOW466</p>
 <p><b>EARTH</b> RGB 88 88 84</p>	<p><b>€ 880</b> HOA332</p>	<p><b>€ 880</b> HOW474</p>	<p><b>€ 940</b> HOW467</p>
 <p><b>BEACH BEIGE</b> RAL1019</p>	<p><b>€ 880</b> HOA623</p>	<p><b>€ 880</b> HOW666</p>	<p><b>€ 940</b> HOW663</p>
 <p><b>OFF WHITE</b> RAL9002</p>	<p><b>€ 880</b> HOA622</p>	<p><b>€ 880</b> HOW665</p>	<p><b>€ 940</b> HOW662</p>
 <p><b>VERDIGRIS</b> RGB 133 147 142</p>	<p><b>€ 880</b> HOA333</p>	<p><b>€ 880</b> HOW481</p>	<p><b>€ 940</b> HOW469</p>
 <p><b>REED GREEN</b> RAL6013</p>	<p><b>€ 880</b> HOA334</p>	<p><b>€ 880</b> HOW476</p>	<p><b>€ 940</b> HOW470</p>
 <p><b>COPPER BROWN</b> RAL8004</p>	<p><b>€ 880</b> HOA624</p>	<p><b>€ 880</b> HOW667</p>	<p><b>€ 940</b> HOW664</p>
 <p><b>COLOR ON REQUEST</b> Only RAL colors Startup fee € 300 (ex. VAT)</p>	<p><b>€ 975</b> HOA336</p>	<p><b>€ 975</b> HOW477</p>	<p><b>€ 1035</b> HOW471</p>

# Hopper shade

© design by Dirk Wynants

In the opened and closed positions, Hopper shade echoes the lines of the Hopper design. It opens and closes effortlessly, thanks to an internal spring mechanism that takes up no extra space beside the table. This foldable canopy creates ample shade for everyone in a simple, aesthetically pleasing way.







Check availability  
[www.extremis.com/portal](http://www.extremis.com/portal)

Outer dimensions (l x w x h)

High-tech polyester fabric + Stainless steel poles AISI 316

Always combine with one of the connection options on the next page

Cover included

		 <b>WHITE</b> <i>Fabric</i>	 <b>GREY TAUPE</b> <i>Fabric</i>
	<p><b>240</b> 241 x 268 x 211 cm</p>	<p><b>€ 4140</b> HSH007</p>	<p><b>€ 4140</b> HSH008</p>
	<p><b>300</b> 301 x 268 x 211 cm</p>	<p><b>€ 4335</b> HSH009</p>	<p><b>€ 4335</b> HSH010</p>
	<p><b>360</b> 361 x 268 x 211 cm</p>	<p><b>€ 4695</b> HSH011</p>	<p><b>€ 4695</b> HSH012</p>



## Friends of the product

Hopper  
picnic

→ p54



Hopper  
picnic AA

→ p54



### ASSEMBLY UNDER HOPPER PICNIC

You need 1 set for every Hopper shade  
(fig. 1)

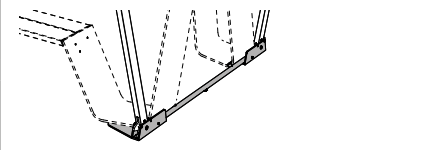
	<p>Only to combine with Hopper picnic 240/300/360 Can not be combined with galvanized steel legs with anchoring holes</p>	<p><b>€ 1290/set</b> HSH013</p>
--	---	-------------------------------------

### ASSEMBLY TO HOPPER LEGS

You need 1 set for every Hopper shade  
(fig. 2)

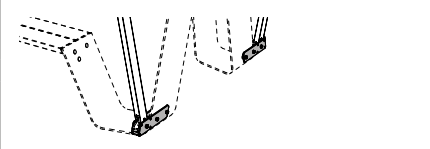
	<p>Attach to Hopper picnic legs (with holes) Only to combine with Hopper picnic 240/300/360 Not possible to add afterwards</p>	<p><b>€ 820/set</b> HSH014</p>
--	--	------------------------------------

### FLOOR FASTENING

You need 1 set for every Hopper shade  
(fig. 3)

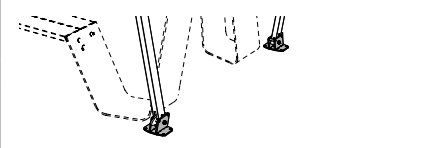
	<p>Combine with any table Screws not included</p>	<p><b>€ 605/set</b> HSH015</p>
--	---	------------------------------------

### CONCRETE BASE

You need 1 set for every Hopper shade - 120 kg  
(fig. 4)

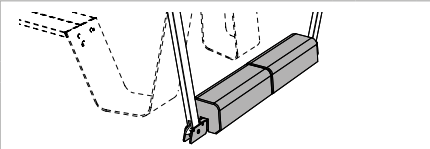
	<p>Combine with any table In combination with Hopper choose the shade 1 size larger, otherwise the table won't fit</p>	<p><b>€ 1260/set</b> HSH016</p>
--	--	-------------------------------------

(fig. 1)

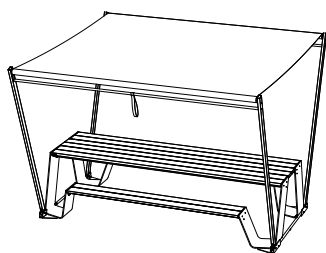

(fig. 2)

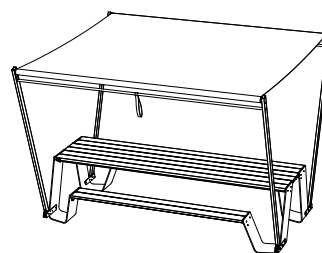

(fig. 3)

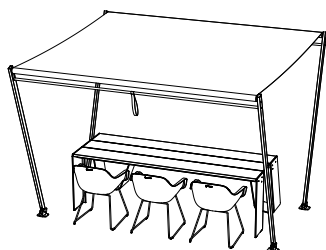

(fig. 4)

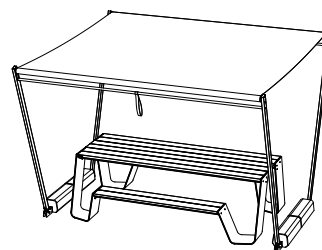

# Inumbra

© design by Dirk Wynants

Inumbra is unique because of its pure aesthetics. The mechanical parts of this umbrella are positioned at the top, resulting in a flat canopy that catches less wind than typical convex shapes. Tests in a windtunnel have shown that the shade withstands wind speeds up to 8 on the Beaufort scale (74 km/h) when anchored to the floor. Still, we strongly advise to close it sooner (from 6 on the Beaufort scale (49 km/h)). When paired with Gargantua or Pantagruel picnic, the umbrella pole is fastened to the tabletop. This looks clean and is also practical, as no legroom is lost under the table. The combination makes it the sturdiest terrace set you have ever seen.



Check availability  
[www.extremis.com/portal](http://www.extremis.com/portal)









ø63,5 mm

## INUMBRA MEDIUM

Outer dimensions (ø): 350 cm

High-tech polyester fabric + Stainless steel pole

Cover included

				
		<b>WHITE</b> <i>Fabric</i>	<b>TAUPE</b> <i>Fabric</i>	<b>BLACK</b> <i>Fabric</i>
		<b>STAINLESS STEEL</b> € 4045  INU001	€ 4045 INU002	€ 4045 INU003
		<b>COLOR ON REQUEST</b> Only RAL colors Startup fee € 300 (ex. VAT)	€ 4650 INU014	€ 4650 INU015



### Friends of the product

Gargantua



→ p42

Pantagruel picnic



→ p108

Pantagruel table



→ p112

Pantagruel high table















→ p114

## INUMBRA LARGE

Outer dimensions (ø): 400 cm

High-tech polyester fabric + Stainless steel or Structured powder coated stainless steel pole

Cover included

		 <b>WHITE</b> <i>Fabric</i>	 <b>TAUPE</b> <i>Fabric</i>	 <b>BLACK</b> <i>Fabric</i>
	 <b>STAINLESS STEEL</b>	<b>€ 4310</b> INU004	<b>€ 4310</b> INU005	<b>€ 4310</b> INU006
	 <b>BLACK</b> RAL9005	/	<b>€ 4625</b>  INU265	<b>€ 4625</b> INU247
	 <b>EARTH</b> RGB 88 88 84	/	<b>€ 4625</b> INU022	/
	 <b>BEACH BEIGE</b> RAL1019	/	<b>€ 4625</b>  INU021	/
	 <b>OFF WHITE</b> RAL9002	<b>€ 4625</b> INU020	/	/
	 <b>COLOR ON REQUEST</b> Only RAL colors Startup fee € 300 (ex. VAT)	<b>€ 4935</b> INU017	<b>€ 4935</b> INU018	<b>€ 4935</b> INU019

## CONNECTION PIECE



Stainless steel  
To combine with Gargantua or Pantagruel



€ 250   
INU007

## FLOOR FASTENING - PARASOL BASE

Outer dimensions (ø x h)

Stainless steel or Structured powder coated stainless steel parasol base



Screws not included

			LOW 25 x 60 cm	HIGH 25 x 70 cm
		<b>STAINLESS STEEL</b>	€ 690 INU009	€ 715 INU010
		<b>COLOR ON REQUEST</b> Only RAL colors Startup fee € 300 (ex. VAT)	€ 795 INU023	€ 820 INU024

## CONCRETE BASE

Outer dimensions (l x w x h)

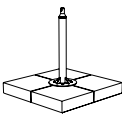
Including stainless steel or Structured powder coated stainless steel parasol base

			LOW 125 kg - 76 x 76 x 71 cm	HIGH 126 kg - 76 x 76 x 81 cm
		<b>STAINLESS STEEL</b>	€ 1120 INU011	€ 1145 INU012
		<b>COLOR ON REQUEST</b> Only RAL colors Startup fee € 300 (ex. VAT)	€ 1225 INU025	€ 1250 INU026

## CONCRETE WHEEL BASE

Outer dimensions (l x w x h): 82 x 82 x 78 cm - 140 kg

Including stainless steel or Structured powder coated stainless steel parasol base

		<b>STAINLESS STEEL</b>	€ 1770 INU013
		<b>COLOR ON REQUEST</b> Only RAL colors Startup fee € 300 (ex. VAT)	€ 1875 INU027

**INUMBRA MEDIUM COMBINATION**

With Gargantua (+ connection piece)



GAR001 + INU001 + INU007

**€ 9480**

**INUMBRA MEDIUM COMBINATION**

With Pantagruel picnic (Hellwood + Off white) (+ connection piece)



PAN626 + INU001 + INU007

**€ 11495**

**INUMBRA LARGE COMBINATION**

With Gargantua (+ connection piece)



GAR001 + INU004 + INU007

**€ 9745**

**INUMBRA LARGE COMBINATION**

With Pantagruel picnic (Hellwood + Earth / Earth + Taupe) (+ connection piece)



PAN002 + INU022 + INU007

**€ 12075**

# Inumbrina

© design by Dirk Wynants

The major difference between Inumbra and Inumbrina lies in how they are operated. Opening and closing the parasol with a rope turns out to be really easy, and even faster! Although the parasol can withstand wind speeds of up to 8 on the Beaufort scale, it is advisable to close it sooner (from wind speed 6 as a rule of thumb).



Check availability  
www.extremis.com/portal







ø48 mm (large)  
ø35 mm (medium)



## INUMBRINA LARGE

Outer dimensions (ø x h): ø380 x 279 cm

High-tech polyester fabric + Stainless steel pole | Cover included

		 <b>WHITE</b> <i>Fabric</i>	 <b>TAUPE</b> <i>Fabric</i>	 <b>BLACK</b> <i>Fabric</i>
	<b>LARGE</b>	<b>€ 2995</b> INI001	<b>€ 2995</b> INI002	<b>€ 2995</b> INI003

## CONNECTION OPTIONS FOR INUMBRINA LARGE

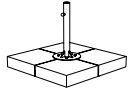
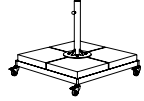
	<b>CONNECTION PIECE</b> Stainless steel To combine with Gargantua or Pantagruel	<b>€ 190</b> INI010
	<b>FLOOR FASTENING</b> Stainless steel parasol base Screws not included	<b>€ 445</b> INI011
	<b>CONCRETE BASE</b> Including stainless steel parasol base 125 kg - 76 x 76 x 60 cm	<b>€ 875</b> INI012
	<b>CONCRETE WHEEL BASE</b> Including stainless steel parasol base 140 kg - 82 x 82 x 68 cm	<b>€ 1525</b> INI013



## Friends of the product

Gargantua

→ p42



Pantagruel  
picnic

→ p108



Pantagruel  
table

→ p112











## INUMBRINA MEDIUM

Outer dimensions (ø x h): ø320 x 251 cm



High-tech polyester fabric + Stainless steel pole | Cover included



				
		<b>WHITE</b> <i>Fabric</i>	<b>TAUPE</b> <i>Fabric</i>	<b>BLACK</b> <i>Fabric</i>
	<b>MEDIUM</b>	<b>€ 2505</b> INI007	<b>€ 2505</b> INI008	<b>€ 2505</b> INI009

## CONNECTION OPTIONS FOR INUMBRINA MEDIUM

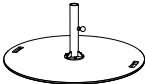
	<b>CONNECTION PIECE</b> Galvanized steel To combine with Anker	<b>€ 120</b> ANK331
---	--	------------------------

	<b>FLOOR FASTENING</b> Stainless steel parasol base Screws not included	<b>€ 325</b> INI014
---	---	------------------------

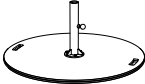
		<b>PARASOL BASE STANDARD</b> Stainless steel parasol base & 1 galvanized steel base plate 27 kg - ø 73 x 29 cm	<b>€ 650</b> INI222
---	---	---	------------------------

		<b>PARASOL BASE HEAVY DUTY</b> Stainless steel parasol base & 2 galvanized steel base plates 52 kg - ø 73 x 30 cm	<b>€ 975</b> INI237
---	---	--	------------------------



## Friends of the product

**Anker**  
(medium)

→ p28



## INUMBRA COMBINATIONS

Gargantua - Pantagruel - stand alone

Inumbra large +  
connection piece & Gargantua

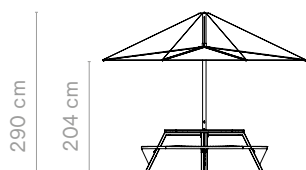

Inumbra large +  
connection piece & Pantagruel picnic

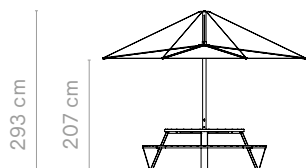

Inumbra large +  
parasol base for floor fastening 60/70

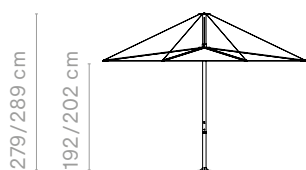

Inumbra large +  
concrete base 71/81

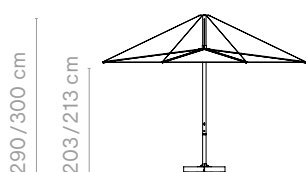

Inumbra large +  
concrete wheel base

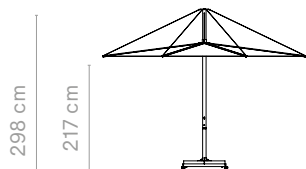

Inumbra medium +  
connection piece & Gargantua

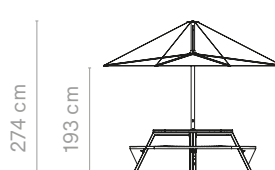

Inumbra medium +  
connection piece & Pantagruel picnic

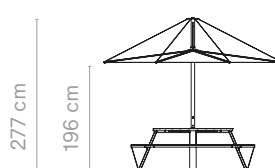

Inumbra medium +  
parasol base for floor fastening 60/70



Inumbra medium +  
concrete base 71/81



Inumbra medium +  
concrete wheel base



# INUMBRINA COMBINATIONS

Gargantua - Pantagruel - Anker - stand alone

Inumbrina large +  
connection piece & Gargantua

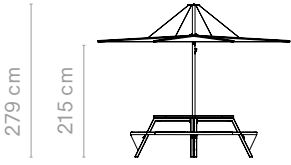

Inumbrina large +  
connection piece & Pantagruel picnic

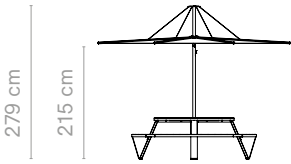

Inumbrina large +  
parasol base for floor fastening

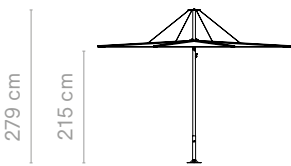

Inumbrina large +  
concrete base



Inumbrina large +  
concrete wheel base



Inumbrina medium +  
Anker

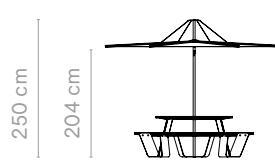

Inumbrina medium +  
parasol base for floor fastening



Inumbrina medium +  
parasol base standard/heavy duty



This table-seat-lounge combination makes efficient use of the space available by combining functionalities such as sofa, meeting spot, dining table and lounge bed. Convert the Kosmos sofa into a lounge bed by setting the adjustable table to its lowest position and adding a cushion.

Combine a base + cushions to compose your favorite Kosmos. Add a deco and lumbar cushion for extra comfort.

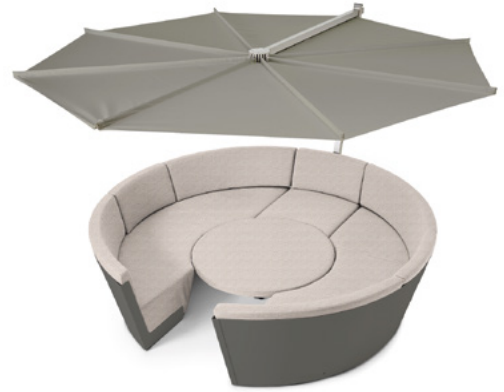

Check availability  
[www.extremis.com/portal](http://www.extremis.com/portal)





## 8-SEATER - BASE | NO PARASOL HOLES

Outer dimensions (ø x h): ø260 x 74 cm

Can not be combined with Kosmos shade

Structured powder coated aluminium shell with matching tabletop color | No cushions included

(Color on request - Startup fee € 300 (ex. VAT))

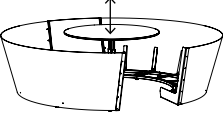
	 <b>BLACK</b> RAL9005	 <b>EARTH</b> RGB 88 88 84	 <b>OFF WHITE</b> RAL9002	 <b>ON REQUEST</b> Only RAL-colors	
	<b>SHELL + FIXED TABLE</b>	€ 7855 KOS604	€ 7855 KOS605	€ 7855 KOS805	€ 8235 KOS008
	<b>SHELL + ADJUSTABLE TABLE</b>	€ 8430 KOS422	€ 8430 KOS609	€ 8430 KOS808	€ 8845 KOS006





## 8-SEATER - BASE | PARASOL READY, WITH HOLES

Outer dimensions (ø x h): ø260 x 74 cm

The back of the shell had a recess to combine with Kosmos shade

Structured powder coated aluminium shell with matching tabletop color | No cushions included

(Color on request - Startup fee € 300 (ex. VAT))

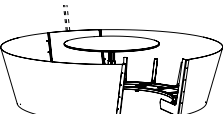
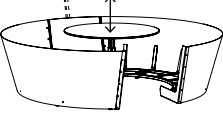
	 <b>BLACK</b> RAL9005	 <b>EARTH</b> RGB 88 88 84	 <b>OFF WHITE</b> RAL9002	 <b>ON REQUEST</b> Only RAL-colors	
	<b>SHELL + FIXED TABLE</b>	€ 7890 KOS606	€ 7890 KOS607	€ 7890 KOS810	€ 8280 KOS004
	<b>SHELL + ADJUSTABLE TABLE</b>	€ 8455 KOS610	€ 8455 KOS597	€ 8455 KOS813	€ 8870 KOS002



### Friends of the product

Deco cushions

→ p40







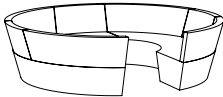

Kosmos shade

→ p80





## 8-SEATER - CUSHIONS

		<b>GREY CHINÉ</b> Sunbrella® Natté	<b>€ 6045</b> KOS335
		<b>DARK TAUPE</b> Sunbrella® Natté	<b>€ 6045</b> KOS014
		<b>MARBLE</b> Sunbrella® Lopi	<b>€ 7290</b> KOS627
		<b>COLOR ON REQUEST 1</b> Only for Sunbrella Natté, Solids, Savane & Heritage	<b>€ 6340</b> KOS015
		<b>COLOR ON REQUEST 2</b> Only for Sunbrella Chartres	<b>€ 7025</b> KOS655
		<b>COLOR ON REQUEST 3</b> Only for Sunbrella Lopi & Domino	<b>€ 7645</b> KOS659

## 8-SEATER - COVER

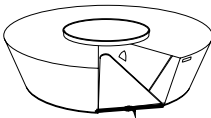
Use a cover if you intend to leave Kosmos outdoors

		<b>WHITE</b> Pvc coated polyester	<b>€ 1180</b> KOS016
---	---	--------------------------------------	-------------------------

## SEATING PLACES

How many people can sit on a Kosmos?

Kosmos 8-seater

8 to 9 people sitting up straight  
 3 to 4 people lying down

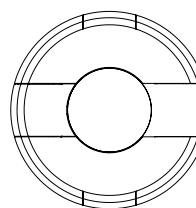





### 3-SEATER - BASE







Outer dimensions (l x w x h): 251 x 95 x 74 cm

Structured powder coated aluminium shell | No cushions included

(Color on request - Startup fee € 300 (ex. VAT))



				
	<b>BLACK</b> RAL9005	<b>EARTH</b> RGB 88 88 84	<b>OFF WHITE</b> RAL9002	<b>ON REQUEST</b> Only RAL-colors
	<b>SHELL</b>	<b>€ 2435</b> KOS368	<b>€ 2435</b> KOS452	<b>€ 2435</b> KOS839
		<b>€ 2805</b> KOS033		

### 3-SEATER - CUSHIONS

		<b>GREY CHINÉ</b> Sunbrella® Natté	<b>€ 2470</b> KOS038
		<b>DARK TAUPE</b> Sunbrella® Natté	<b>€ 2470</b> KOS338
	<b>MARBLE</b> Sunbrella® Lopi	<b>€ 2980</b> KOS635	
	<b>COLOR ON REQUEST 1</b> Only for Sunbrella Natté, Solids, Savane & Heritage	<b>€ 2590</b> KOS040	
	<b>COLOR ON REQUEST 2</b> Only for Sunbrella Chartres	<b>€ 2870</b> KOS654	
	<b>COLOR ON REQUEST 3</b> Only for Sunbrella Lopi & Domino	<b>€ 3125</b> KOS658	

### 3-SEATER - COVER

Use a cover if you intend to leave Kosmos outdoors

		<b>WHITE</b> Pvc coated polyester	<b>€ 620</b> KOS041
---	---	--------------------------------------	------------------------

## SEATING PLACES

How many people can sit on a Kosmos?

Kosmos 3-seater

3 to 4 people

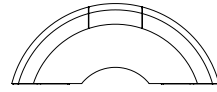

# Kosmos shade

© design by Dirk Wynants

The Kosmos shade has an ingenious design and opens horizontally like a fan. Tests in a windtunnel have shown that the shade withstands wind speeds up to 6 on the Beaufort scale (49 km/h) when anchored to the floor. Still, we strongly advise to close it sooner (from 4 on the Beaufort scale (28 km/h)). This designer shade hangs low enough to provide plenty of shade, and is perfect for placing next to the Kosmos table and seat combination or any other furniture. Two hidden magnets keep the parasol open.





Check availability  
[www.extremis.com/portal](http://www.extremis.com/portal)

## ROUND SHADE

Outer dimensions (ø x h)

High-tech polyester fabric + Stainless steel pole AISI 316 | Cover included

Shade + LED: In countries where this type of plug is not used, a different plug will need to be fitted (cable = 10 meter)

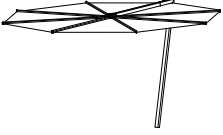
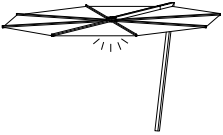
		 <b>WHITE</b> <i>Fabric</i>	 <b>TAUPE</b> <i>Fabric</i>	 <b>BLACK</b> <i>Fabric</i>
	<b>STANDARD</b> ø325 x 200 cm	<b>€ 3765</b> KSH001	<b>€ 3765</b> KSH002	<b>€ 3765</b> KSH003
	<b>HIGH</b> 15 cm extra height ø325 x 215 cm	<b>€ 3900</b> KSH004	<b>€ 3900</b> KSH005	<b>€ 3900</b> KSH006
	<b>STANDARD + LED LIGHT</b> IP65 - 3000K ø325 x 200 cm	<b>€ 4310</b> KSH007	<b>€ 4310</b> KSH008	<b>€ 4310</b> KSH009
	<b>HIGH + LED LIGHT</b> IP65 - 3000K   15 cm extra height ø325 x 215 cm	<b>€ 4440</b> KSH010	<b>€ 4440</b> KSH011	<b>€ 4440</b> KSH012



### Friends of the product

Kosmos

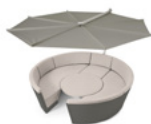

→ p76

Walrus



→ p152





## SQUARE SHADE

Outer dimensions (l x w x h)

High-tech polyester fabric + Stainless steel pole AISI 316 | Cover included

Shade + LED: In countries where this type of plug is not used, a different plug will need to be fitted (cable = 10 meter)

\* Leaving the collection. Available while supplies last

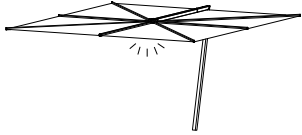
		 <b>WHITE</b> <i>Fabric</i>
	<b>STANDARD *</b> 325 x 325 x 200 cm	<b>€ 4110</b> KSH013
	<b>HIGH *</b> 15 cm extra height 325 x 325 x 215 cm	<b>€ 4225</b> KSH016
	<b>STANDARD + LED LIGHT *</b> IP65 - 3000K 325 x 325 x 200 cm	<b>€ 4665</b> KSH019
	<b>HIGH + LED LIGHT *</b> IP65 - 3000K   15 cm extra height 325 x 325 x 215 cm	<b>€ 4790</b> KSH022

## CONNECTION OPTIONS

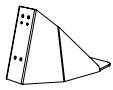
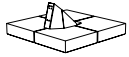
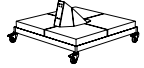
	<b>FLOOR FASTENING</b> Stainless steel parasol base Screws not included	<b>€ 405</b> KSH025
	<b>CONCRETE BASE</b> Including parasol base 125 kg - 76 x 76 x 32,5 cm	<b>€ 835</b> KSH026
	<b>CONCRETE WHEEL BASE</b> Including parasol base 140 kg - 82 x 82 x 40 cm	<b>€ 1485</b> KSH027

# KOSMOS SHADE ROUND COMBINATIONS

Stand alone - Kosmos 8-seater

Kosmos shade round +  
floor fastening

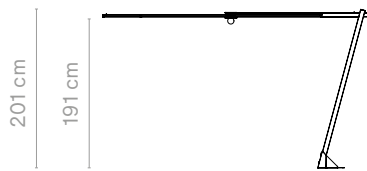

Kosmos shade round high +  
floor fastening

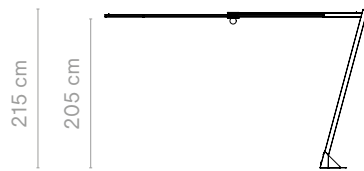

Kosmos shade round +  
concrete base

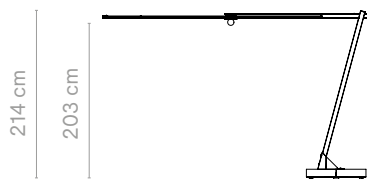

Kosmos shade round high +  
concrete base

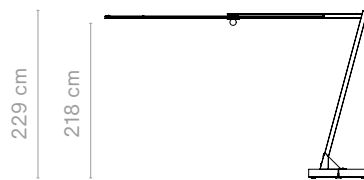

Kosmos shade round +  
concrete wheel base

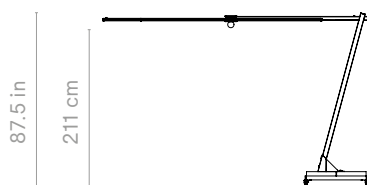

Kosmos shade round high +  
concrete wheel base

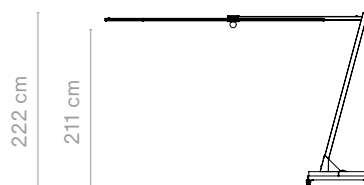

Kosmos shade round +  
Kosmos 8-seater

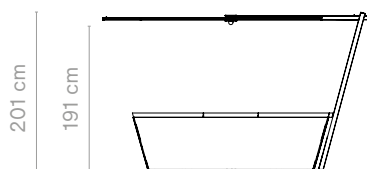

Kosmos shade round high +  
Kosmos 8-seater

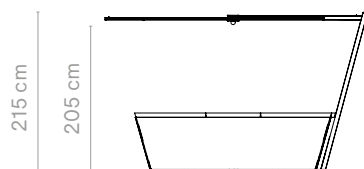

# KOSMOS SHADE SQUARE COMBINATIONS

Stand alone

Kosmos shade square +  
floor fastening

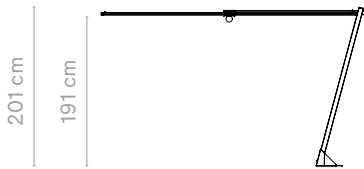

Kosmos shade square high +  
floor fastening

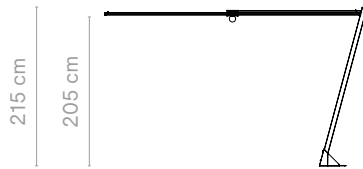

Kosmos shade square +  
concrete base



Kosmos shade square high +  
concrete base

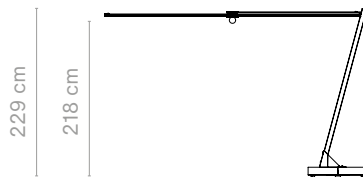

Kosmos shade square +  
concrete wheel base



Kosmos shade square high +  
concrete wheel base

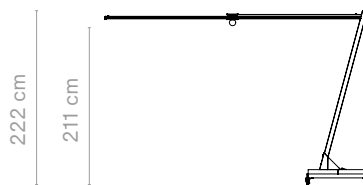

# Manille

© design by Dirk Wynants

Designed as a table with bench formation, this picnic table comfortably accommodates up to four people on the benches while the head of the table is reserved for wheelchair users - making Manille an inclusive and accessible table for everyone; a true tool for togetherness. What makes this picnic table stand out is its versatility. Extend the table in length by connecting multiple tables together. Thanks to a simple connection piece, you can join as many tables as you want. The shade creates an intimate cocoon whenever you need it.



 Check availability  
www.extremis.com/portal

 Wheelchair accessible  
→ p175

 Shades → p85  
Coupling → p86

## MANILLE

Outer dimensions (l x w x h): 144 x 177 x 74 cm - 4 people

Structured powder coated stainless steel legs + Galvanized steel frame + Hellwood tabletop & benches

Hellwood = 100% PEFC



		<b>EARTH</b> RGB 88 88 84	<b>€ 3850</b> MNL001
		<b>COPPER BROWN</b> RAL8004	<b>€ 3850</b> MNL002
		<b>COSMIC CREAM</b> RAL1015	<b>€ 3850</b>  MNL003
		<b>PISTACHE</b> RAL6021	<b>€ 4085</b> MNL004
		<b>COLOR ON REQUEST</b> Only RAL colors Startup fee € 300 (ex. VAT)	<b>€ 4145</b> MNL005

## FLOOR FASTENING

Anchoring plate (screws not included)

	Stainless steel 1 set: 2 pieces	<b>€ 60/set</b> MNL008
---	------------------------------------	---------------------------

### SOFT SHADE

Outer dimensions (l x w x h): 171 x 245 x 187 cm

Stainless steel poles + High-tech polyester fabric

Only compatible with the Manille | Storage bag for canopy included

		<b>WHITE</b>	<b>€ 1150</b>  MNL006
---	---	--------------	---

### FIXED SHADE





Outer dimensions (l x w x h): 172 x 241 x 216 cm

Structured powder coated stainless steel poles + Structured powder coated aluminium top structure + Glamping tent fabric Light Ivory RAL1015

Only compatible with the Manille

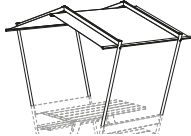
If you combine Manille with the Fixed shade, floor fastening is necessary

The floor fastening plate is supplied (screws not included)

		<b>EARTH</b> RGB 88 88 84	<b>€ 2350</b> MNL009
		<b>COPPER BROWN</b> RAL8004	<b>€ 2350</b> MNL010
		<b>COSMIC CREAM</b> RAL1015	<b>€ 2350</b> MNL011
		<b>PISTACHE</b> RAL6021	<b>€ 2620</b> MNL012
		<b>COLOR ON REQUEST</b> Only RAL colors Startup fee € 300 (ex. VAT)	<b>€ 2680</b> MNL013

## COUPLING - WOOD

Outer dimensions tabletop (l x w): 71 x 28 cm

Hellwood tabletop + Galvanized steel frame

Hellwood = 100% PEFC



		<b>HELLWOOD</b>	<b>€ 515</b> MNL007
--	--	-----------------	------------------------

## COUPLING - POWDER COATED

Outer dimensions tabletop (l x w): 71 x 28 cm

Structured powder coated ZnAlMg tabletop

		<b>EARTH</b> RGB 88 88 84	<b>€ 295</b> MNL014
		<b>COPPER BROWN</b> RAL8004	<b>€ 295</b> MNL015
		<b>COSMIC CREAM</b> RAL1015	<b>€ 295</b> MNL016
		<b>PISTACHE</b> RAL6021	<b>€ 340</b> MNL017
		<b>COLOR ON REQUEST</b> Only RAL colors Startup fee € 300 (ex. VAT)	<b>€ 340</b> MNL018

## MANILLE

How many people can sit on a Manille?

144 cm  
4 people

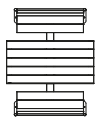

317 cm  
8 people

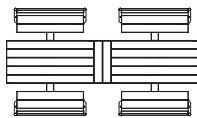

490 cm  
12 people

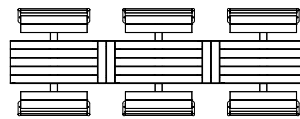

663 cm  
16 people

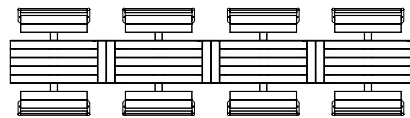

**MANILLE COMBINATION**  
Manille (Earth) with soft shade



MNL001 + MNL006

€ 5000

**MANILLE COMBINATION**  
Manille (Earth) with two soft shades & one coupling piece (wood)



MNL001 (x2) + MNL006 (x2) + MNL007

€ 10515

**MANILLE COMBINATION**  
Manille (Pistache) with fixed shade (floor fastening incl.)



MNL004 + MNL012

€ 6845

**MANILLE COMBINATION**  
Three Manilles (Pistache) with & two powder coated coupling pieces



MNL004 (x3) + MNL017 (x2)

€ 12935





# Marina combo

© design by Metrica

A combination of chairs and benches is what makes this range really unique. You can have a frequent use zone with Captain's Chairs that offer high comfort, and still have plenty of visitors over, offering seats on the benches.

Other combinations on request. If the length of the table exceeds 6m, special transport surcharges might be applicable.



-  Check availability  
[www.extremis.com/portal](http://www.extremis.com/portal)
-  Wheelchair accessible  
 → p174
-  Charging module  
 → p178
-  Cushions → p93  
 Floor fastening → p91

## HOW DO I GET THE CORRECT PRODUCT CODE?

Complement the dots with the correct color code mentioned below

 <b>OFF WHITE</b> <i>RAL9002</i>	 <b>VERDIGRIS</b> <i>RGB 133 147 142</i>	 <b>REED GREEN</b> <i>RAL6013</i>	 <b>COPPER BROWN</b> <i>RAL8004</i>	 <b>ON REQUEST</b> <i>Only RAL colors</i> <i>Startup fee € 300 (ex. VAT)</i>
MAO...	MAV...	MAG...	MAC...	MAQ... + 15% surcharge per piece

## 3 LEGS

Outer dimensions 5 profiles (l x w x h): L x 155 x 75 cm | Outer dimensions 6 profiles (l x w x h): L x 170 x 75 cm

Structured powder coated zinced steel legs + coated fiberglass reinforced polyester tabletop & benches

	5 PROFILES <i>Tabletop width 72 cm</i>	6 PROFILES <i>Tabletop width 87 cm</i>	
	<b>L 360 CM</b> Bench length 165 cm	<b>€ 5085</b> ...003	<b>€ 5710</b> ...004
	<b>L 415 CM</b> Bench length 220 cm	<b>€ 5900</b> ...005	<b>€ 6640</b> ...006
	<b>L 470 CM</b> Bench length 275 cm	<b>€ 6715</b> ...007	<b>€ 7530</b> ...008
	<b>L 485 CM</b> Bench length 220 cm	<b>€ 6515</b> ...009	<b>€ 7345</b> ...010
	<b>L 595 CM</b> Bench length 330 cm	<b>€ 7725</b> ...011	<b>€ 8705</b> ...012



### Friends of the product

Captain's Chair



→ p34

Sensu



→ p118



### 4 LEGS

Outer dimensions 5 profiles (l x w x h): L x 155 x 75 cm | Outer dimensions 6 profiles (l x w x h): L x 170 x 75 cm  
 Structured powder coated zinced steel legs + coated fiberglass reinforced polyester tabletop & benches

		<b>5 PROFILES</b> <i>Tabletop width 72 cm</i>	<b>6 PROFILES</b> <i>Tabletop width 87 cm</i>
	<b>L 595 CM</b> Bench length 165 cm   165 cm	<b>€ 8450</b> ...013	<b>€ 9445</b> ...014

### 5 LEGS

Outer dimensions 5 profiles (l x w x h): L x 155 x 75 cm | Outer dimensions 6 profiles (l x w x h): L x 170 x 75 cm  
 Structured powder coated zinced steel legs + coated fiberglass reinforced polyester tabletop & benches

		<b>5 PROFILES</b> <i>Tabletop width 72 cm</i>	<b>6 PROFILES</b> <i>Tabletop width 87 cm</i>
	<b>L 665 CM</b> Bench length 165 cm   165 cm	<b>€ 9450</b> ...015	<b>€ 10610</b> ...016

### MARINA COMBO + CAPTAIN'S CHAIRS

How many people can sit on a Marina combo?

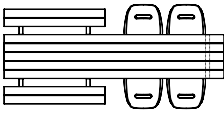
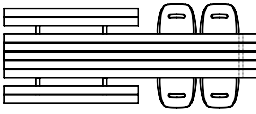
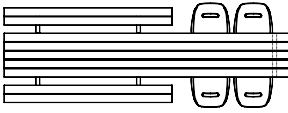
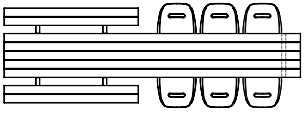
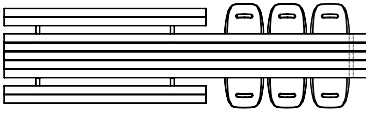
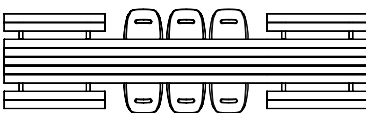
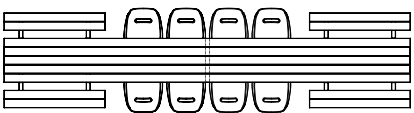
3 legs	<b>360 cm</b> 10 people (4 Captain's Chairs)	
	<b>415 cm</b> 12 people (4 Captain's Chairs)	
	<b>470 cm</b> 14 people (4 Captain's Chairs)	
	<b>485 cm</b> 14 people (6 Captain's Chairs)	
	<b>595 cm</b> 18 people (6 Captain's Chairs)	
4 legs	<b>595 cm</b> 18 people (6 Captain's Chairs)	
5 legs	<b>665 cm</b> 20 people (8 Captain's Chairs)	

# Marina picnic

© design by Metrica

The marvel of the Marina picnic design is that the tabletop is one seamless piece, creating a calm and uninterrupted aesthetic. With benches on both sides, this piece is a perfect example of the Extremis 'Tools for Togetherness' philosophy, bringing up to 26 people together at standard lengths of up to 7,15 meters. If the length of the table exceeds 6m, special transport surcharges might be applicable.



 Check availability  
www.extremis.com/portal

 Wheelchair accessible  
→ p174

 Charging module  
→ p178

 Cushions → p93  
Floor fastening → p91

## HOW DO I GET THE CORRECT PRODUCT CODE?

Complement the dots with the correct color code mentioned below

 <b>OFF WHITE</b> RAL9002	 <b>VERDIGRIS</b> RGB 133 147 142	 <b>REED GREEN</b> RAL6013	 <b>COPPER BROWN</b> RAL8004	 <b>ON REQUEST</b> Only RAL colors Startup fee € 300 (ex. VAT)
MAO...	MAV...	MAG...	MAC...	MAQ... + 15% surcharge per piece

## 2 LEGS

Outer dimensions 5 profiles (l x w x h): L x 155 x 75 cm | Outer dimensions 6 profiles (l x w x h): L x 170 x 75 cm

Structured powder coated zinc steel legs + coated fiberglass reinforced polyester tabletop & benches | 55 cm/person

		<b>5 PROFILES</b> Tabletop width 72 cm	<b>6 PROFILES</b> Tabletop width 87 cm
	<b>L 165 CM</b>	€ 3315 ...021	€ 3580 ...022
	<b>L 220 CM</b>	€ 4125 ...023	€ 4480 ...024
	<b>L 275 CM</b>	€ 4905 ...025	€ 5360 ...026
	<b>L 330 CM</b>	€ 5640 ...001	€ 5980 ...027



### Friends of the product

Sensu



→ p118

### 3 LEGS

Outer dimensions 5 profiles (l x w x h): L x 155 x 75 cm | Outer dimensions 6 profiles (l x w x h): L x 170 x 75 cm

Structured powder coated zinc coated steel legs + coated fiberglass reinforced polyester tabletop & benches | 55 cm/person

	<b>5 PROFILES</b> <i>Tabletop width 72 cm</i>	<b>6 PROFILES</b> <i>Tabletop width 87 cm</i>
	<b>L 385 CM</b> ...028	<b>€ 6775</b> ...029
	<b>L 440 CM</b> ...030	<b>€ 7615</b> ...031
	<b>L 495 CM</b> ...032	<b>€ 8410</b> ...033
	<b>L 550 CM</b> ...034	<b>€ 8635</b> ...035

### 4 LEGS

Outer dimensions 5 profiles (l x w x h): L x 155 x 75 cm | Outer dimensions 6 profiles (l x w x h): L x 170 x 75 cm

Structured powder coated zinc coated steel legs + coated fiberglass reinforced polyester tabletop & benches | 55 cm/person

	<b>5 PROFILES</b> <i>Tabletop width 72 cm</i>	<b>6 PROFILES</b> <i>Tabletop width 87 cm</i>
	<b>L 605 CM</b> ...036	<b>€ 9740</b> ...037
	<b>L 660 CM</b> ...038	<b>€ 10505</b> ...039
	<b>L 715 CM</b> ...040	<b>€ 11240</b> ...041

### FLOOR FASTENING SET

	Bolts included Not for Marina Bistro 1 set: 2 pieces	<b>€ 80/set</b> MAR121
---	--	---------------------------

## MARINA PICNIC

How many people can sit on a Marina picnic?

These are all available standard sizes

Legs	Length (cm)	Capacity (people)	Legs	Length (cm)	Capacity (people)
2 legs	165 cm	6 people	4 legs	605 cm	22 people
	220 cm	8 people		660 cm	24 people
	275 cm	10 people		715 cm	26 people
	330 cm	12 people			
3 legs	385 cm	14 people			
	440 cm	16 people			
	495 cm	18 people			
	550 cm	20 people			

## MARINA PICNIC - MADE TO MEASURE

Formulas for calculating the price of the tables with non standard sizes up to 660 cm

	<b>PRICE OF CUSTOM LENGTH (5 PROFILES)</b> Price of the table of the next standard length	<b>+ € 200</b>
	<b>PRICE OF CUSTOM LENGTH (6 PROFILES)</b> Price of the table of the next standard length	<b>+ € 220</b>

### Examples

	<b>CUSTOM LENGTH: 250 X 154 X 75 CM</b> € 4905 (Price MAV025) + € 200	<b>+ € 5105</b>
	<b>CUSTOM LENGTH: 250 X 170 X 75 CM</b> € 5360 (Price MAV026) + € 220	<b>+ € 5580</b>











## CUSHIONS

Outer dimensions (l x w x t) - 1 piece

Pick the cushion according to the length of your bench

Please store the cushions inside when not in use

	<b>165 CM</b> <i>165 x 29 x 3 cm</i>	<b>220 CM</b> <i>220 x 29 x 3 cm</i>	<b>275 CM</b> <i>275 x 29 x 3 cm</i>	
	<b>GREY CHINÉ</b> Sunbrella® Natté	<b>€ 370</b> MAR789	<b>€ 485</b> MAR791	<b>€ 580</b> MAR793
	<b>DARK TAUPE</b> Sunbrella® Natté	<b>€ 370</b> MAR803	<b>€ 485</b> MAR804	<b>€ 580</b> MAR805
	<b>MARBLE</b> Sunbrella® Lopi	<b>€ 470</b> MAR776	<b>€ 575</b> MAR790	<b>€ 685</b> MAR792
	<b>LEAF GREEN</b> Sunbrella® Heritage	<b>€ 370</b> MAR809	<b>€ 485</b> MAR810	<b>€ 580</b> MAR811
	<b>RUST</b> Sunbrella® Heritage	<b>€ 370</b> MAR812	<b>€ 485</b> MAR813	<b>€ 580</b> MAR814
	<b>COLOR ON REQUEST 1</b> Only for Sunbrella Natté, Solids, Savane & Heritage	<b>€ 395</b> MAR794	<b>€ 510</b> MAR797	<b>€ 610</b> MAR800
	<b>COLOR ON REQUEST 2</b> Only for Sunbrella Chartres	<b>€ 440</b> MAR795	<b>€ 565</b> MAR798	<b>€ 650</b> MAR801
	<b>COLOR ON REQUEST 3</b> Only for Sunbrella Lopi & Domino	<b>€ 495</b> MAR796	<b>€ 605</b> MAR799	<b>€ 710</b> MAR802

# Marina double desk

© design by Metrica

The Marina double desk is perfect for office environments. The desk has two tabletops with only one set of legs, an ideal solution for open-plan offices. The fiberglass tabletop is very strong, yet it feels as pleasant as wood. In between the desk, there's a space for plugs and cables or extra accessories.

Other lengths and accessories on request. If the length of the table exceeds 6m, special transport surcharges might be applicable.



Check availability  
www.extremis.com/portal



Wheelchair accessible  
→ p174



Charging module  
→ p178

## HOW DO I GET THE CORRECT PRODUCT CODE?

Complement the dots with the correct color code mentioned below

 <b>OFF WHITE</b> RAL9002	 <b>VERDIGRIS</b> RGB 133 147 142	 <b>REED GREEN</b> RAL6013	 <b>COPPER BROWN</b> RAL8004	 <b>ON REQUEST</b> Only RAL colors Startup fee € 300 (ex. VAT)
MAO...	MAV...	MAG...	MAC...	MAQ... + 15% surcharge per piece

## 2 LEGS

Outer dimensions 2 x 5 profiles (l x w x h): L x 149 x 75 cm | Outer dimensions 2 x 6 profiles (l x w x h): L x 178 x 75 cm  
 Structured powder coated zinc steel legs + coated fiberglass reinforced polyester tabletop | 70 cm/Captain's Chair

	<b>2 X 5 PROFILES</b> Tabletop width 149 cm	<b>2 X 6 PROFILES</b> Tabletop width 178 cm
	<b>L 405 CM</b>	<b>€ 7270</b> ...122
		<b>€ 8650</b> ...123

## MONITOR HOLDER

	Stainless steel 316	<b>€ 370</b> MAR770
---	---------------------	------------------------



### Friends of the product

Captain's Chair



→ p34

Sensu



→ p118

## MARINA DOUBLE DESK - MADE TO MEASURE

Formulas for calculating the price of the tables with non standard sizes up to 660 cm



### PRICE OF CUSTOM LENGTH (5 OR 6 PROFILES)

2 x price of table of the next standard length - (number of legs x € 50)

### Examples



### CUSTOM LENGTH: 500 X 72 X 75 CM

2 x € 5145 (Price MAV069) - (3 x € 50)

**+ € 10440**

# Marina tables

© design by Metrica

The Marina table set is available without the attached seating benches to create a free-standing table. Marina table is not only unlimited in length, you can also extend the long architectural lines from the terrace through to the dining room, from the office workspace through to the office canteen. Boundaries blur between work and play, indoors and outdoors. If the length of the table exceeds 6m, special transport surcharges might be applicable.



 Check availability  
www.extremis.com/portal

 Wheelchair accessible  
→ p174

 Charging module  
→ p178

## HOW DO I GET THE CORRECT PRODUCT CODE?

Complement the dots with the correct color code mentioned below

 <b>OFF WHITE</b> RAL9002	 <b>VERDIGRIS</b> RGB 133 147 142	 <b>REED GREEN</b> RAL6013	 <b>COPPER BROWN</b> RAL8004	 <b>ON REQUEST</b> Only RAL colors Startup fee € 300 (ex. VAT)
MAO...	MAV...	MAG...	MAC...	MAQ... + 15% surcharge per piece

## TABLE - 2 LEGS

Outer dimensions 5 profiles (l x w x h): L x 72 x 75 cm | Outer dimensions 6 profiles (l x w x h): L x 87 x 75 cm

Structured powder coated zinced steel legs + coated fiberglass reinforced polyester tabletop | 70 cm/Captain's Chair

		5 PROFILES Tabletop width 72 cm	6 PROFILES Tabletop width 87 cm
	L 195 CM	€ 2280 ...060	€ 2640 ...061
	L 265 CM	€ 2860 ...062	€ 3330 ...063
	L 335 CM	€ 3460 ...064	€ 4065 ...065
	L 405 CM	€ 3800 ...066	€ 4485 ...067



### Friends of the product

Captain's Chair



→ p34

Sensu



→ p118



**TABLE - 3 LEGS**

Outer dimensions 5 profiles (l x w x h): L x 72 x 75 cm | Outer dimensions 6 profiles (l x w x h): L x 87 x 75 cm

Structured powder coated zinc steel legs + coated fiberglass reinforced polyester tabletop | 70 cm/Captain's Chair

		<b>5 PROFILES</b> <i>Tabletop width 72 cm</i>	<b>6 PROFILES</b> <i>Tabletop width 87 cm</i>
	<b>L 475 CM</b>	<b>€ 4590</b> ...068	<b>€ 5370</b> ...002
	<b>L 545 CM</b>	<b>€ 5145</b> ...069	<b>€ 6055</b> ...070
	<b>L 615 CM</b>	<b>€ 5740</b> ...071	<b>€ 6760</b> ...072
	<b>L 685 CM</b>	<b>€ 6270</b> ...073	<b>€ 7400</b> ...074

**FLOOR FASTENING SET**

	<p>Bolts included Not for Marina Bistro 1 set: 2 pieces</p>	<p><b>€ 80/set</b> MAR121</p>
--	---	-----------------------------------

# Marina high table

© design by Metrica

The Marina table is also available in a high version, 105 cm to be precise. Extend the architectural lines of the table from your terrace to your dining room and from your office workspace to your office canteen. Whether indoors or outdoors, these tables blur the boundaries between work and play and turn an individual space into a shared one. If the length of the table exceeds 6m, special transport surcharges might be applicable.



 Check availability  
www.extremis.com/portal

 Charging module  
→ p178

## HOW DO I GET THE CORRECT PRODUCT CODE?

Complement the dots with the correct color code mentioned below

 <b>OFF WHITE</b> RAL9002	 <b>VERDIGRIS</b> RGB 133 147 142	 <b>REED GREEN</b> RAL6013	 <b>COPPER BROWN</b> RAL8004	 <b>ON REQUEST</b> <i>Only RAL colors</i> <i>Startup fee € 300 (ex. VAT)</i>
MAO...	MAV...	MAG...	MAC...	MAQ... + 15% surcharge per piece

## HIGH TABLE - 2 LEGS

Outer dimensions 5 profiles (l x w x h): L x 72 x 105 cm | Outer dimensions 6 profiles (l x w x h): L x 87 x 105 cm

Structured powder coated zinced steel legs + coated fiberglass reinforced polyester tabletop | 70cm/Captain's Chair

		5 PROFILES <i>Tabletop width 72 cm</i>	6 PROFILES <i>Tabletop width 87 cm</i>
	L 195 CM	<b>€ 2400</b> ...091	<b>€ 2740</b> ...092
	L 265 CM	<b>€ 2980</b> ...093	<b>€ 3430</b> ...094
	L 335 CM	<b>€ 3580</b> ...095	<b>€ 4165</b> ...096
	L 405 CM	<b>€ 3920</b> ...097	<b>€ 4585</b> ...098



### Friends of the product

Captain's Chair  
high



→ p37

Sensu



→ p118

Tiki  
bar stool



→ p138

### HIGH TABLE - 3 LEGS

Outer dimensions 5 profiles (l x w x h): L x 72 x 105 cm | Outer dimensions 6 profiles (l x w x h): L x 87 x 105 cm

Structured powder coated zinced steel legs + coated fiberglass reinforced polyester tabletop | 70cm/Captain's Chair

		<b>5 PROFILES</b> <i>Tabletop width 72 cm</i>	<b>6 PROFILES</b> <i>Tabletop width 87 cm</i>
	<b>L 475 CM</b>	<b>€ 4770</b> ...099	<b>€ 5520</b> ...100
	<b>L 545 CM</b>	<b>€ 5325</b> ...101	<b>€ 6205</b> ...102
	<b>L 615 CM</b>	<b>€ 5920</b> ...103	<b>€ 6910</b> ...104
	<b>L 685 CM</b>	<b>€ 6450</b> ...105	<b>€ 7550</b> ...106

### FLOOR FASTENING SET

	Bolts included Not for Marina Bistro 1 set: 2 pieces	<b>€ 80/set</b> MAR121
--	--	---------------------------

## MARINA (HIGH) TABLE - MADE TO MEASURE

Formulas for calculating the price of the tables with non standard sizes up to 660 cm

	<b>PRICE OF CUSTOM LENGTH (5 PROFILES)</b> Price of the table of the next standard length	<b>+ € 135</b>
	<b>PRICE OF CUSTOM LENGTH (6 PROFILES)</b> Price of the table of the next standard length	<b>+ € 150</b>

### Examples

	<b>CUSTOM LENGTH: 250 X 72 X 75 CM</b> € 2860 (Price MAV062) + € 135	<b>€ 2995</b>
	<b>CUSTOM LENGTH: 250 X 87 X 75 CM</b> € 3330 (Price MAV063) + € 150	<b>€ 3480</b>

# MARINA (HIGH) TABLE & DOUBLE DESK + CAPTAIN'S CHAIRS

How many people can sit on a Marina (high) table & Marina double desk?

Legs	Length (cm)	Number of Chairs	Notes
2 legs	195 cm	4 Captain's Chairs	
	265 cm	6 Captain's Chairs	
	335 cm	8 Captain's Chairs	
	405 cm	10 Captain's Chairs	
	475 cm	12 Captain's Chairs	
3 legs	545 cm	14 Captain's Chairs	Position of the legs is asymmetrical
	615 cm	16 Captain's Chairs	
	685 cm	18 Captain's Chairs	Position of the legs is asymmetrical

# Panigiri

© design by Dirk Wynants

'Pan giri' in Greek stands for 'gathering all,' and that's what this design is all about. Choose between a table with chairs, a picnic table, or a combination of both. The smart position of the benches allow easy entry without lifting your leg. Experience optimal comfort with BYOS (Bring Your Own Seat) and convenient slide-on cushions. The new Captain's Chairs Pipe Legs perfectly complement the organic, round shapes of this table.



The modular design of Panigiri offers you the freedom to add extra modules at a later time, to extend togetherness.



Check availability  
www.extremis.com/portal



Wheelchair accessible  
→ p175



Cushions → p103







## BASE MODULES

Outer dimensions (l x w x h) - Tabletop width 100 cm

Structured powder coated stainless steel legs + Galvanized steel frame + Hellwood tabletop (& benches)

Hellwood = 100% PEFC



			
	<b>COMBO</b> 326 x 180 x 74 cm - 8 people Possible to fit 4 to 6 chairs	<b>PICNIC</b> 326 x 180 x 74 cm - 8 people Possible to fit 2 chairs	<b>TABLE</b> 326 x 100 x 74 cm Possible to fit 8 to 10 chairs
	<b>BLACK</b> RAL9005 € 7275 PNG001	<b>€ 8790</b> PNG006	<b>€ 5760</b> PNG011
	<b>EARTH</b> RGB 88 88 84 € 7275  PNG002	<b>€ 8790</b>  PNG007	<b>€ 5760</b>  PNG012
	<b>BEACH BEIGE</b> RAL1019 € 7275 PNG003	<b>€ 8790</b> PNG008	<b>€ 5760</b> PNG013
	<b>OFF WHITE</b> RAL9002 € 7275 PNG004	<b>€ 8790</b> PNG009	<b>€ 5760</b> PNG014
	<b>ON REQUEST</b> Only RAL colors Startup fee € 300 (ex. VAT) € 7720 PNG005	<b>€ 9320</b> PNG010	<b>€ 6120</b> PNG015



## Friends of the product

Captain's Chair  
pipe legs



→ p36

Sensu  
tilted



→ p119







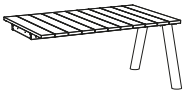

## ADDITIONAL MODULES

Outer dimensions (l x w x h) - Tabletop width 100 cm

Structured powder coated stainless steel legs + Galvanized steel frame + Hellwood tabletop (& benches)

Hellwood = 100% PEFC



	 <b>PICNIC MODULE</b> 156 x 180 x 74 cm Adds 4 people	 <b>TABLE MODULE</b> 156 x 100 x 74 cm Adds 4 people
 <b>BLACK</b> RAL9005	<b>€ 4325</b> PNG016	<b>€ 2810</b> PNG021
 <b>EARTH</b> RGB 88 88 84	<b>€ 4325</b>  PNG017	<b>€ 2810</b>  PNG022
 <b>BEACH BEIGE</b> RAL1019	<b>€ 4325</b> PNG018	<b>€ 2810</b> PNG023
 <b>OFF WHITE</b> RAL9002	<b>€ 4325</b> PNG019	<b>€ 2810</b> PNG024
 <b>ON REQUEST</b> Only RAL colors Startup fee € 300 (ex. VAT)	<b>€ 4590</b> PNG020	<b>€ 2990</b> PNG025

## BYOS

Outer dimensions (l x w x h): 50 x 46 x 46 cm

Earth structured powder coated steel frame + Sunbrella fabric + Taupe polypropylene yarn

Please store the BYOS inside when not in use

Only compatible with Panigiri

1 set: 2 pieces

		<b>COCONUT</b> Sunbrella® Savane	<b>€ 990/set</b> PNG175
		<b>MARBLE</b> Sunbrella® Lopi	<b>€ 1030/set</b>  PNG176

## SLIDE-ON CUSHION

Outer dimensions (l x w x h): 50 x 25 x 3 cm

Sunbrella fabric

This cushion effortlessly slides between the planks of the bench, ensuring it remains securely in place and won't blow away

Please store the cushions inside when not in use

Only compatible with Panigiri

		<b>COCONUT</b> Sunbrella® Savane	<b>€ 140</b> PNG029
		<b>MARBLE</b> Sunbrella® Lopi	<b>€ 155</b>  PNG028

**PANIGIRI COMBO + ADDITIONAL PICNIC MODULE**

Outer dimensions (l x w x h): 482 x 180 x 74 cm - 12 people | Possible to fit 4 to 6 Captain's Chairs

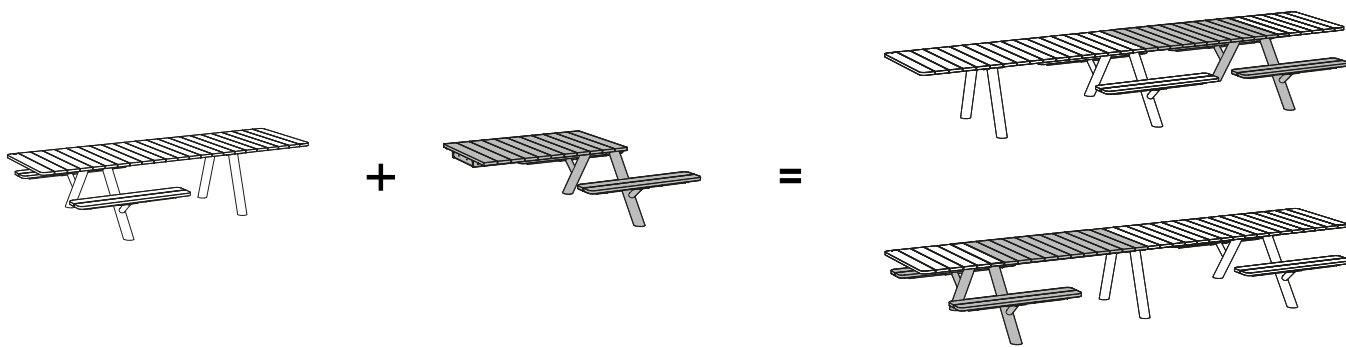

**PANIGIRI COMBO + ADDITIONAL TABLE MODULE**

Outer dimensions (l x w x h): 482 x 180 x 74 cm - 12 people | Possible to fit 8 to 10 Captain's Chairs

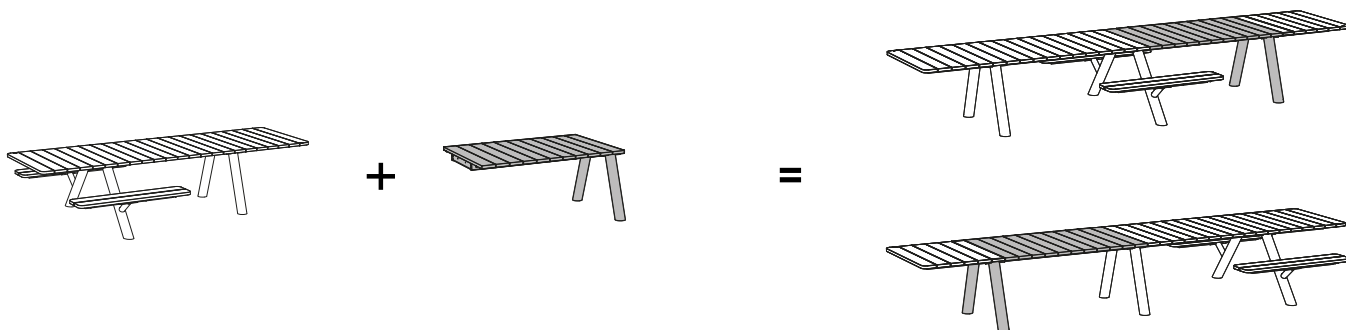

**PANIGIRI PICNIC + ADDITIONAL PICNIC MODULE**

Outer dimensions (l x w x h): 482 x 180 x 74 cm - 12 people

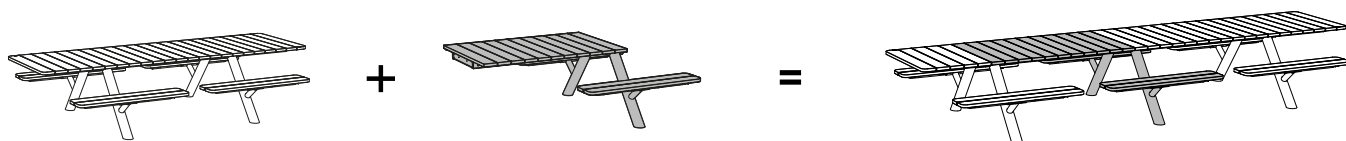

**PANIGIRI TABLE + ADDITIONAL TABLE MODULE**

Outer dimensions (l x w x h): 482 x 100 x 74 cm - Possible to fit 12 to 14 Captain's Chairs

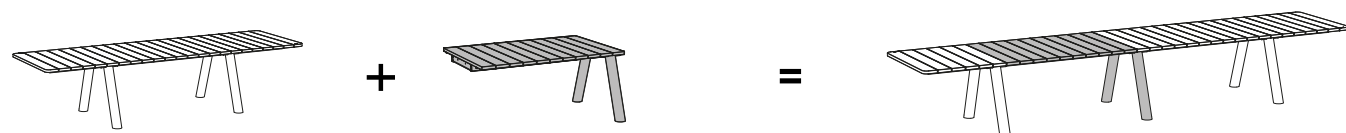



### PANIGIRI COMBO + CAPTAIN'S CHAIRS

How many people can sit on a Panigiri combo?

**326 cm**  
8 people  
(4 to 6 Captain's Chairs)

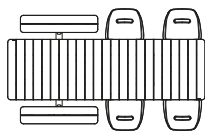

**482 cm**  
12 people  
(4 to 6 Captain's Chairs)

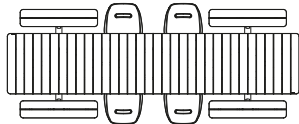

**482 cm**  
12 people  
(4 to 6 Captain's Chairs)

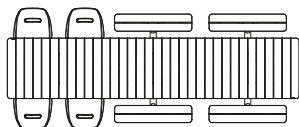

**638 cm**  
16 people  
(4 to 6 Captain's Chairs)

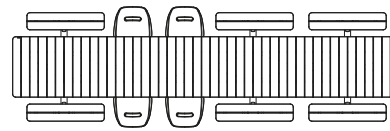

**638 cm**  
16 people  
(8 to 10 Captain's Chairs)

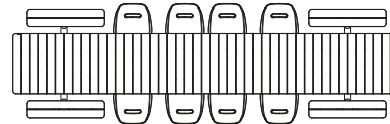

**794 cm**  
20 people  
(8 to 10 Captain's Chairs)

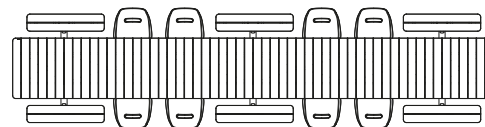

### PANIGIRI PICNIC

How many people can sit on a Panigiri picnic?

**326 cm**  
8 people

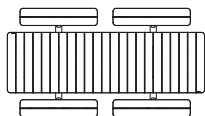

**482 cm**  
12 people

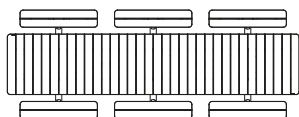

**638 cm**  
16 people

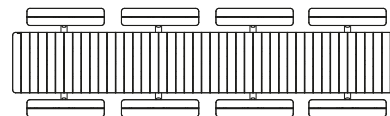

**794 cm**  
20 people

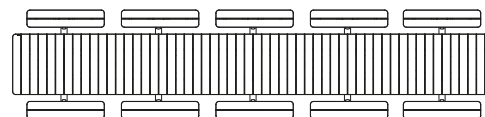

### PANIGIRI TABLE + CAPTAIN'S CHAIRS

How many people can sit on a Panigiri table?

**326 cm**  
(8 to 10 Captain's Chairs)

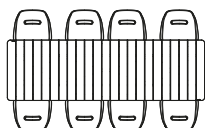

**482 cm**  
(12 to 14 Captain's Chairs)

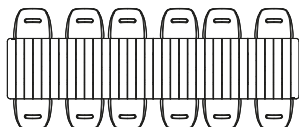

**638 cm**  
(16 to 18 Captain's Chairs)

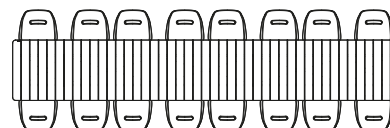

**794 cm**  
(20 to 22 Captain's Chairs)

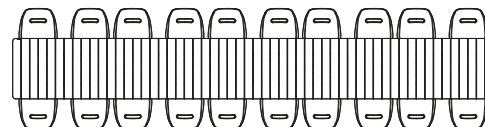

## PANIGIRI COMBINATIONS

Some predefined combinations

### PANIGIRI COMBO + SENSU TILTED + CAPTAIN'S CHAIRS

Panigiri combo base module (Earth) + 4 x Captain's Pipe Chairs (Earth) + Sensu single square tilted with wheel base (Earth/White) + Weights

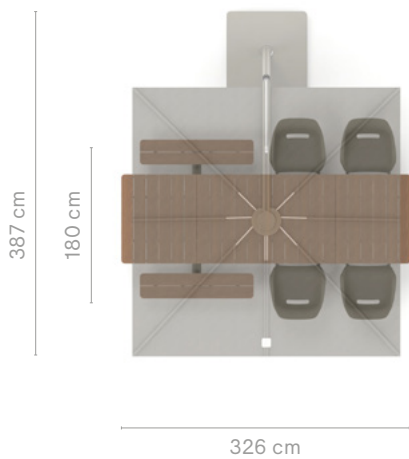

PNG002 + CAP271 (x4) + CAP031 (x4)  
+ SEN184 + SEN069 + SEN191

€ 14590

### PANIGIRI TABLE + CAPTAIN'S CHAIRS

Panigiri table base module (Earth) + 8 x Captain's Pipe chairs (Earth)

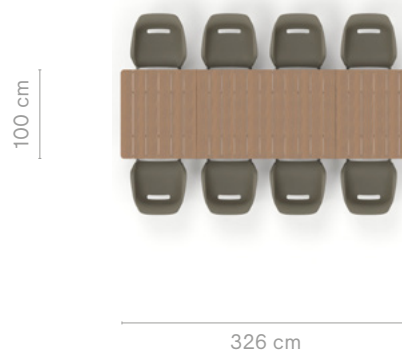

PNG012 + CAP271 (x8) + CAP031 (x8)

€ 7620

## PANIGIRI COMBINATIONS

Some predefined combinations

### PANIGIRI COMBINATION + CHAIRS

Panigiri combo base module (Earth) + Panigiri additional picnic module (Earth) + 8 x Slide-on cushions (Coconut) + 4 x Captain's Pipe Chairs (Earth legs & shell)



PNG002 + PNG017 + PNG029 (x8) +  
CAP271 (x4) + CAP031 (x4)

€ 14580

### PANIGIRI COMBINATION + SENSU TILTED + CHAIRS

Panigiri picnic base module (Earth) + Panigiri additional table module (Earth) + 4 x Captain's Pipe Chairs (Earth) + 2 x Sensu single square tilted with wheel base (Earth/White) + 2 x Weights

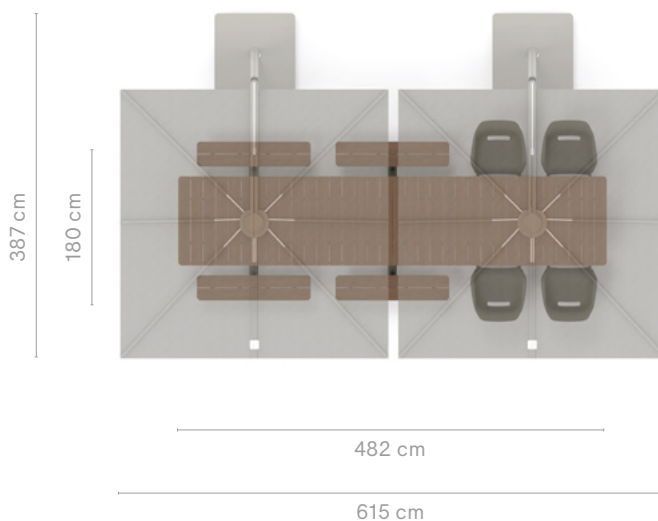

PNG007 + PNG022 + CAP271 (x4) + CAP031 (x4) +  
SEN184 (x2) + SEN069 (x2) + SEN191 (x2)

€ 24370

# Pantagruel picnic

© design by Dirk Wynants

The Pantagruel round picnic table seats eight. The frame is available in a powder coated or galvanized finish. When combined with the wood used for the tabletop and benches it forms a durable outdoor picnic set. Pantagruel also features a Lazy Susan, to take the hard work out of passing food and drinks around.



Check availability  
[www.extremis.com/portal](http://www.extremis.com/portal)



Charging module  
→ p178











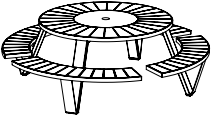

ø65 mm

Outer dimensions (ø x h): 227 x 75 cm

Galvanized steel legs & frame OR Structured powder coated stainless steel legs + structured powder coated zinc steel tabletop- and bench frame + HPL Lazy Susan (in the same color as the legs)

Hellwood = 100% PEFC

		  <b>HELLWOOD</b> <i>Thermally treated wood tabletop &amp; benches</i>	 <b>IROKO</b> <i>Tropical hardwood tabletop &amp; benches</i>	
		<b>GALVANIZED STEEL</b> & Off white HPL Lazy Susan	<b>€ 6590</b> PAN004	<b>€ 7015</b> PAN009
		<b>BLACK</b> RAL9005	<b>€ 7200</b>  PAN003	<b>€ 7640</b> PAN008
		<b>EARTH</b> RGB 88 88 84	<b>€ 7200</b> PAN002	<b>€ 7640</b> PAN007
		<b>BEACH BEIGE</b> RAL1019	<b>€ 7200</b>  PAN628	<b>€ 7640</b> PAN624
		<b>OFF WHITE</b> RAL9002	<b>€ 7200</b> PAN626	<b>€ 7640</b> PAN617
		<b>COLOR ON REQUEST</b> Only RAL colors Startup fee € 300 (ex. VAT)	<b>€ 8290</b> PAN005	<b>€ 8795</b> PAN010



## Friends of the product

Inumbra  
medium / large

→ p68



Inumbra  
large









→ p72

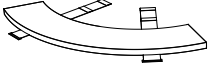

## CUSHIONS

1 set: 4 pieces









Please store the cushions inside when not in use

		<b>GREY CHINÉ</b> Sunbrella® Natté	<b>€ 930/set</b> PAN489
		<b>DARK TAUPE</b> Sunbrella® Natté	<b>€ 930/set</b> PAN634
		<b>COCONUT</b> Sunbrella® Savane	<b>€ 930/set</b> PAN635
		<b>MARBLE</b> Sunbrella® Lopi	<b>€ 1255/set</b>  PAN507
		<b>COLOR ON REQUEST 1</b> Only for Sunbrella Natté, Solids, Savane & Heritage	<b>€ 955/set</b> PAN018
		<b>COLOR ON REQUEST 2</b> Only for Sunbrella Chartres	<b>€ 1070/set</b> PAN521
		<b>COLOR ON REQUEST 3</b> Only for Sunbrella Lopi & Domino	<b>€ 1280/set</b> PAN522

## BACKRESTS

Galvanized steel or Structured powder coated zinc steel

1 set: 2 pieces

		<b>GALVANIZED STEEL</b>	<b>€ 745/set</b> PAN011
		<b>BLACK</b> RAL9005	<b>€ 1005/set</b>  PAN012
		<b>EARTH</b> RGB 88 88 84	<b>€ 1005/set</b> PAN013
		<b>BEACH BEIGE</b> RAL1019	<b>€ 1005/set</b>  PAN632
		<b>OFF WHITE</b> RAL9002	<b>€ 1005/set</b> PAN630
		<b>COLOR ON REQUEST</b> Only RAL colors Startup fee € 300 (ex. VAT)	<b>€ 1060/set</b> PAN015

## OPTIONS

1 set: 4 pieces



**FLOOR FASTENING**  
Galvanized steel  
Anchoring plate (screws not included)

**€ 115/set**  
PAN019

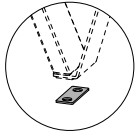

**PROTECTION FELT FOR INDOOR USE**  
Anthracite felt

**€ 45/set**  
PAN020

## CONNECTION OPTIONS

To combine with Inumbra or Inumbrina



**CONNECTION PIECE INUMBRA**  
Inumbra medium - large  
Stainless steel

**€ 250**   
INU007



**CONNECTION PIECE INUMBRINA**  
Inumbrina large  
Stainless steel  
Inner ø5 cm

**€ 190**  
INI010

## PANTAGRUEL PICNIC COMBINATION

With Inumbrina large (+ connection piece)



PAN626 + INI001 + INI010

€ 10385

## PANTAGRUEL PICNIC COMBINATION

With Inumbra large (+ connection piece) & 1 set backrests



PAN003 + PAN012  
+ INU247 + INU007

€ 13080

# Pantagrue table

© design by Dirk Wynants

The Pantagrue table easily seats eight. With several color and material options, it fits in any indoor or outdoor space. The round shape allows everyone to take part in the conversation and have eye contact, which makes it ideal for a round table meeting. The Lazy Susan in the center makes sharing easy with others around the table.



We recommend using floor fastening when combined with Inumbra.



Check availability  
www.extremis.com/portal



Charging module  
→ p178











ø65 mm

Outer dimensions (ø x h): 146 x 75 cm

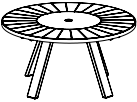
Galvanized steel legs & tabletop frame OR Structured powder coated stainless steel legs + structured powder coated zinc plated steel tabletop frame + HPL

Lazy Susan (in the same color as the legs)

Hellwood = 100% PEFC

		  <b>HELLWOOD</b> <i>Thermally treated wood tabletop</i>	 <b>IROKO</b> <i>Tropical hardwood tabletop</i>	
		<b>BLACK</b> RAL9005	<b>€ 4215</b> PAN027	<b>€ 4485</b> PAN022
		<b>EARTH</b> RGB 88 88 84	<b>€ 4215</b> PAN028	<b>€ 4485</b> PAN023
		<b>BEACH BEIGE</b> RAL1019	<b>€ 4215</b> PAN600	<b>€ 4485</b> PAN602
		<b>OFF WHITE</b> RAL9002	<b>€ 4215</b> PAN596	<b>€ 4485</b> PAN604
		<b>COLOR ON REQUEST</b> Only RAL colors Startup fee € 300 (ex. VAT)	<b>€ 4850</b> PAN030	<b>€ 5155</b> PAN025



## Friends of the product

Captain's Chair

→ p34



Inumbra  
medium / large

→ p68



Inumbra  
large

→ p72





## OPTIONS

1 set: 4 pieces



### FLOOR FASTENING

Galvanized steel  
Anchoring plate (screws not included)

€ 115/set

PAN019

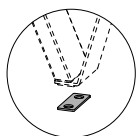

### PROTECTION FELT FOR INDOOR USE

Anthracite felt

€ 45/set

PAN020

## CONNECTION OPTIONS

To combine with Inumbra or Inumbrina

We recommend using floor fastening when combined with Inumbra



### CONNECTION PIECE INUMBRA

Inumbra medium - large  
Stainless steel

€ 250 

INU007



### CONNECTION PIECE INUMBRINA

Inumbrina large  
Stainless steel  
Inner ø5 cm

€ 190

INI010

# Pantagrue high table

© design by Dirk Wynants



Looking for a cocktail table with the refined yet sturdy Pantagrue look? Behold the Pantagrue high table. Eight chairs and even more stools fit around the extra-large tabletop. In the center you will find an HPL Lazy Susan, with which to easily pass things around. The light design uses highly durable, outdoor-resistant materials.

We recommend using floor fastening when combined with Inumbra. Can not be combined with Inumbra large.



Check availability  
[www.extremis.com/portal](http://www.extremis.com/portal)



Charging module  
 → p178









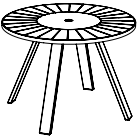

ø65 mm

Outer dimensions (ø x h): 146 x 105 cm

Galvanized steel legs & tabletop frame OR Structured powder coated stainless steel legs + structured powder coated zinc coated steel tabletop frame + HPL Lazy Susan (in the same color as the legs)

Hellwood = 100% PEFC

		  <b>HELLWOOD</b> <i>Thermally treated wood tabletop</i>	 <b>IROKO</b> <i>Tropical hardwood tabletop</i>	
		<b>BLACK</b> RAL9005	<b>€ 4550</b> PAN037	<b>€ 4820</b> PAN032
		<b>EARTH</b> RGB 88 88 84	<b>€ 4550</b> PAN038	<b>€ 4820</b> PAN033
		<b>BEACH BEIGE</b> RAL1019	<b>€ 4550</b> PAN612	<b>€ 4820</b> PAN607
		<b>OFF WHITE</b> RAL9002	<b>€ 4550</b> PAN614	<b>€ 4820</b> PAN610
		<b>COLOR ON REQUEST</b> Only RAL colors Startup fee € 300 (ex. VAT)	<b>€ 5235</b> PAN040	<b>€ 5540</b> PAN035



## Friends of the product

Captain's Chair  
 high



→ p37

Inumbra  
 medium / large



→ p68

Tiki  
 bar stool



→ p138

## OPTIONS

1 set: 4 pieces

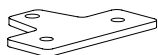

**FLOOR FASTENING**  
Galvanized steel  
Anchoring plate (screws not included)

**€ 115/set**  
PAN019

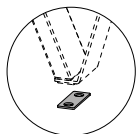

**PROTECTION FELT FOR INDOOR USE**  
Anthracite felt

**€ 45/set**  
PAN020

## CONNECTION OPTIONS

To combine with Inumbra

We recommend using floor fastening when combined with Inumbra



**CONNECTION PIECE INUMBRA**  
Inumbra medium - large  
Stainless steel

**€ 250**   
INU007

Picnik is made from a single sheet of aluminum, cut and bent to shape with zero waste. The form seats two people comfortably at the tabletop and withstands the harshest of the elements outdoors. A perfect example of 'form follows function', Picnik is a true design classic in the Extremis collection.



Check availability  
[www.extremis.com/portal](http://www.extremis.com/portal)











Wheelchair accessible  
 → p175

## STANDARD FEET

Outer dimensions (l x w x h): 147 x 95 x 75 cm

Structured powder coated aluminium + Stainless steel feet (6 pcs)









		<b>OFF WHITE</b> RAL9002	<b>€ 4795</b> PIC272
		<b>VERDIGRIS</b> RGB 133 147 142	<b>€ 4795</b> PIC003
		<b>COPPER BROWN</b> RAL8004	<b>€ 4795</b>  PIC004
		<b>COBALT BLUE</b> RAL5013	<b>€ 5515</b> PIC005
		<b>SUN YELLOW</b> RAL1032	<b>€ 5515</b> PIC270
		<b>PISTACHE</b> RAL6021	<b>€ 5515</b> PIC274
		<b>ON REQUEST</b> Only RAL colors Startup fee € 300 (ex. VAT)	<b>€ 5515</b> PIC007

## FLOOR FASTENING FEET

Outer dimensions (l x w x h): 147 x 95 x 75 cm

Structured powder coated aluminium + Stainless steel feet (4 pcs)









Screws not included

		<b>OFF WHITE</b> RAL9002	<b>€ 4990</b> PIC276
		<b>VERDIGRIS</b> RGB 133 147 142	<b>€ 4990</b> PIC022
		<b>COPPER BROWN</b> RAL8004	<b>€ 4990</b> PIC023
		<b>COBALT BLUE</b> RAL5013	<b>€ 5490</b> PIC024
		<b>SUN YELLOW</b> RAL1032	<b>€ 5490</b> PIC275
		<b>PISTACHE</b> RAL6021	<b>€ 5490</b> PIC277
		<b>ON REQUEST</b> Only RAL colors Startup fee € 300 (ex. VAT)	<b>€ 5490</b> PIC026

## PROTECTION FEET WITH FELT

Outer dimensions (l x w x h): 147 x 95 x 75 cm

Structured powder coated aluminium + Stainless steel feet with felt for delicate floors (6 pcs)

		<b>OFF WHITE</b> RAL9002	<b>€ 5045</b> PIC279
		<b>VERDIGRIS</b> RGB 133 147 142	<b>€ 5045</b> PIC030
		<b>COPPER BROWN</b> RAL8004	<b>€ 5045</b> PIC031
		<b>COBALT BLUE</b> RAL5013	<b>€ 5550</b> PIC032
		<b>SUN YELLOW</b> RAL1032	<b>€ 5550</b> PIC278
		<b>PISTACHE</b> RAL6021	<b>€ 5550</b> PIC280
		<b>ON REQUEST</b> Only RAL colors Startup fee € 300 (ex. VAT)	<b>€ 5550</b> PIC034

# Sensu

© design by Dirk Wynants

This freestanding shade opens horizontally like a hand fan and does not take up any space on your precious table. Thanks to its flat surface, Sensu offers excellent wind resistance while also keeping any technical parts out of sight. This floating shade opens and closes effortlessly while by cantilevering Sensu, you optimally cast the shade. The modular central pole can hold one, two, or even four shades for a maximum shade surface. Sensu is the perfect tool for enjoying a cool moment with friends and/or colleagues on a sunny day.









Check availability  
[www.extremis.com/portal](http://www.extremis.com/portal)

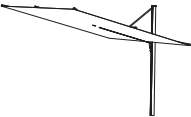

Base options → p122

## SINGLE SQUARE - STRAIGHT

Outer dimensions (l x w x h): 323 x 300 x 250 cm | The shade itself is 300 x 300 cm  
 Acrylic fabric (cover included) + Structured powder coated aluminium pole (ø88 mm)  
 Always combine with one of the connection options on page 122/123  
 360 degree rotating system included

		 <b>WHITE</b> <i>Fabric</i>	 <b>TAUPE</b> <i>Fabric</i>	 <b>BLACK</b> <i>Fabric</i>
	 <b>OFF WHITE</b> RAL9002	<b>€ 3925</b> SEN178	<b>€ 3925</b> SEN179	<b>€ 3925</b> SEN180
	 <b>EARTH</b> RGB 88 88 84	<b>€ 3925</b> SEN006	<b>€ 3925</b> SEN005	<b>€ 3925</b> SEN004
	 <b>BLACK</b> RAL9005	<b>€ 3925</b> SEN007	<b>€ 3925</b> SEN008	<b>€ 3925</b> SEN009



### Friends of the product

**Hopper  
 combo**



→ p48

**Hopper  
 combo AA**



→ p49

**Marina  
 combo**



→ p88

**Marina  
 picnic**



→ p90

**Marina  
 table**



→ p96

**Marina  
 high table**



→ p98

**Panigiri combo,  
 picnic, table**



→ p102

**Walrus**



→ p152









### SINGLE SQUARE - TILTED

Outer dimensions (l x w x h): 347 x 300 x 250 cm | The shade itself is 300 x 300 cm

Acrylic fabric (cover included) + Structured powder coated aluminium pole (ø88 mm)

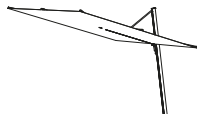
Always combine with one of the connection options on page 122/123

360 degree rotating system included - The pole of the shade is leaning forward

		 <b>WHITE</b> <i>Fabric</i>	 <b>TAUPE</b> <i>Fabric</i>	 <b>BLACK</b> <i>Fabric</i>	
		<b>OFF WHITE</b> RAL9002	€ 3925 SEN181	€ 3925 SEN182	€ 3925 SEN183
		<b>EARTH</b> RGB 88 88 84	€ 3925 SEN184	€ 3925  SEN185	€ 3925 SEN186
		<b>BLACK</b> RAL9005	€ 3925 SEN187	€ 3925 SEN188	€ 3925 SEN189

### STRAIGHT

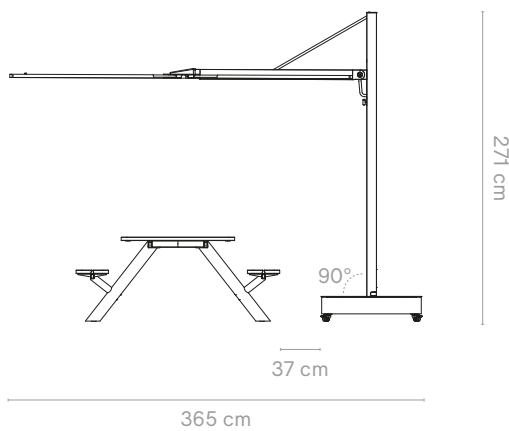

### TILTED

Creates more space between the base & table

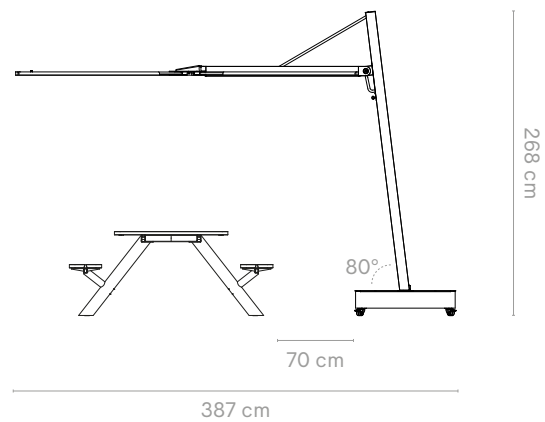

### Friends of the product

Panigiri  
combo



→ p102

Panigiri  
picnic



→ p102

Panigiri  
table



→ p102

## DUO SQUARE

Outer dimensions (l x w x h): 640 x 300 x 250 cm | The shades itself are 300 x 300 cm  
Acrylic fabric (cover included) + Structured powder coated aluminium pole (Pole ø114 mm)  
Always combine with one of the connection options on page 122/123

		<b>OFF WHITE</b> RAL9002 White fabric	<b>€ 6735</b> SEN229
		<b>EARTH</b> RGB 88 88 84 Taupe fabric	<b>€ 6735</b> SEN020
		<b>BLACK</b> RAL9005 Black fabric	<b>€ 6735</b> SEN024



## DUO DIAMOND

Outer dimensions (l x w x h): 526 x 270 x 250 cm | The shades itself are 250 x 250 cm  
Acrylic fabric (cover included) + Structured powder coated aluminium pole (Pole ø114 mm)  
Always combine with one of the connection options on page 122/123

		<b>OFF WHITE</b> RAL9002 White fabric	<b>€ 6315</b> SEN231
		<b>EARTH</b> RGB 88 88 84 Taupe fabric	<b>€ 6315</b> SEN035
		<b>BLACK</b> RAL9005 Black fabric	<b>€ 6315</b> SEN039

## QUATTRO DIAMOND

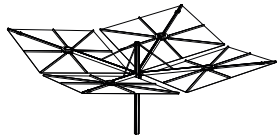
Outer dimensions (l x w x h): 526 x 526 x 250 cm | The shades itself are 250 x 250 cm  
Acrylic fabric (cover included) + Structured powder coated aluminium pole (Pole ø114 mm)  
Always combine with one of the connection options on page 122/123











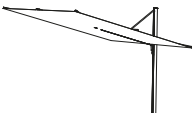



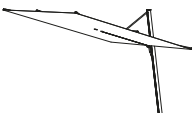



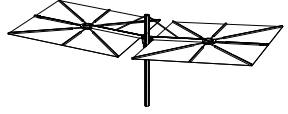

		<b>OFF WHITE</b> RAL9002 White fabric	<b>€ 11775</b> SEN233
		<b>EARTH</b> RGB 88 88 84 Taupe fabric	<b>€ 11775</b> SEN050
		<b>BLACK</b> RAL9005 Black fabric	<b>€ 11775</b> SEN054

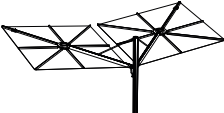

**FIXATION OPTIONS**

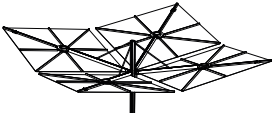
Start by identifying the ground type, as this will guide your choice of fixation:

- **For solid ground** (f.i. tiled or concrete areas): you can chose between a wheel base (for mobility), a feet base or floor fastening
- **For soft ground** (f.i. a lawn): we recommend concrete anchoring

Parasol type	Pole color	CHOOSE YOUR FIXATION				Pole extension Recommended for floor fastening and concrete anchoring
		Wheel base Movable	Feet base Stationary	Floor fastening Drilling required	Concrete anchoring Digging required	
 <b>SINGLE STRAIGHT</b>		SEN190	SEN190 + SEN240			SEN193
		SEN069	SEN069 + SEN240	SEN239	SEN100	SEN106
		SEN067	SEN067 + SEN240			SEN107
 <b>SINGLE TILTED</b>		SEN190	SEN190 + SEN240			SEN194
		SEN069	SEN069 + SEN240	SEN239	SEN100	SEN195
		SEN067	SEN067 + SEN240			SEN196
 <b>DUO SQUARE</b> Pole is in the center		SEN190	SEN190 + SEN240			SEN234
		SEN069	SEN069 + SEN240	SEN237	SEN100	SEN109
		SEN067	SEN067 + SEN240			SEN110
 <b>DUO DIAMOND</b> Pole is out of the center		SEN190	SEN190 + SEN240			SEN234
		SEN069	SEN069 + SEN240	SEN237	SEN100	SEN109
		SEN067	SEN067 + SEN240			SEN110
 <b>QUATTRO DIAMOND</b> Pole is in the center		SEN190	SEN190 + SEN240			SEN234
		SEN069	SEN069 + SEN240	SEN237	SEN100	SEN109
		SEN067	SEN067 + SEN240			SEN110

**Weights**







SEN191  
(or add your own weights min. 153 kg)

## WHEEL BASE

Outer dimensions (l x w x h): 88 x 88 x 22 cm

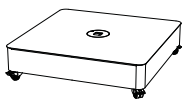
Structured powder coated aluminium (wheels are included)

Weights not included - Do not use without any weight (minimum 153 kg)

		<b>OFF WHITE</b> RAL9002	<b>€ 1275</b> SEN190
		<b>EARTH</b> RGB 88 88 84	<b>€ 1275</b>  SEN069
		<b>BLACK</b> RAL9005	<b>€ 1275</b> SEN067



## BASE FEET

1 set: 4 pieces

	Rubber	<b>€ 60/set</b> SEN240
---	--------	---------------------------

## WEIGHTS

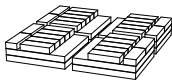
Tile set of concrete blocks for the base

	Concrete blocks 153 kg	<b>€ 255</b>  SEN191
--	---------------------------	---

## PERMANENT FIXATION

To fix in soft ground | Insert in concrete foundation

When using the permanent fixation, it is highly recommended to order a pole extension to increase the height by 15 cm to ensure head clearance

	Galvanized steel Screws not included	<b>€ 285</b> SEN100
---	---	------------------------



## FLOOR FASTENING - SINGLE STRAIGHT & TILTED

Outer dimensions (ø x h): ø16 x 2,5 cm

To fix on solid ground

When using this, it is highly recommended to order a pole extension to increase the height by 15 cm to ensure head clearance

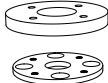
Only compatible with Sensu Single square straight & tilted

	HDPE - High density polyethylene spacer plate with galvanized steel floor fastening plate Screws not included	<b>€ 170</b>  SEN239
---	---	--

## FLOOR FASTENING - DUO & QUATTRO

Outer dimensions (ø x h): ø14 x 0,8 cm

To fix on solid ground

When using the floor fastening, it is highly recommended to order a pole extension to increase the height by 15 cm to ensure head clearance

Only compatible with Sensu Duo Square, Duo Diamond & Quattro Diamond

	Galvanized steel Screws not included	<b>€ 60</b> SEN237
---	---	-----------------------





### POLE EXTENSION - SINGLE STRAIGHT

Extends the pole of the shade with 15 cm

Galvanized steel connection piece with structured powder coated aluminium pole extension

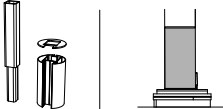
When using the floor fastening with spacer plate (SEN239) or permanent fixation (SEN100), it is highly recommended to order a pole extension to increase the height by 15 cm to ensure head clearance

Only compatible with Sensu Single square straight

		<b>OFF WHITE</b> RAL9002	<b>€ 145</b> SEN193
		<b>EARTH</b> RGB 88 88 84	<b>€ 145</b> SEN106
		<b>BLACK</b> RAL9005	<b>€ 145</b> SEN107





### POLE EXTENSION - SINGLE TILTED

Extends the pole of the shade with 15 cm

Galvanized steel connection piece with structured powder coated aluminium pole extension

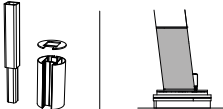
When using the floor fastening with spacer plate (SEN239) or permanent fixation (SEN100), it is highly recommended to order a pole extension to increase the height by 15 cm to ensure head clearance

Only compatible with Sensu Single square tilted





		<b>OFF WHITE</b> RAL9002	<b>€ 145</b> SEN194
		<b>EARTH</b> RGB 88 88 84	<b>€ 145</b>  SEN195
		<b>BLACK</b> RAL9005	<b>€ 145</b> SEN196

### POLE EXTENSION - DUO & QUATTRO

Extends the pole of the shade with 15 cm

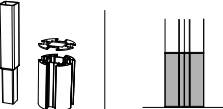
Galvanized steel connection piece with structured powder coated aluminium pole extension | When using the permanent fixation (SEN100) or floor fastening (SEN237), it is highly recommended to order a pole extension to increase the height by 15 cm to ensure head clearance

Only compatible with Sensu Duo square, Duo diamond & Quattro diamond

		<b>OFF WHITE</b> RAL9002	<b>€ 200</b> SEN234
		<b>EARTH</b> RGB 88 88 84	<b>€ 200</b> SEN109
		<b>BLACK</b> RAL9005	<b>€ 200</b> SEN110

**SENSU COMBINATION**

Sensu single straight (Earth/Taupe) + wheel base (Earth)  
(No weights)



SEN005 + SEN069

€ 5200

**SENSU COMBINATION**

Sensu duo square (Earth/Taupe) + wheel base (Earth)  
(No weights)



SEN020 + SEN069

€ 8010

**SENSU COMBINATION**

Sensu single tilted (Earth/White) + wheel base (Earth)  
(No weights)



SEN185 + SEN069

€ 5200

**SENSU COMBINATION**

Sensu duo diamond (Earth/Taupe) + wheel base (Earth)  
(No weights)



SEN035 + SEN069

€ 7590

Single square

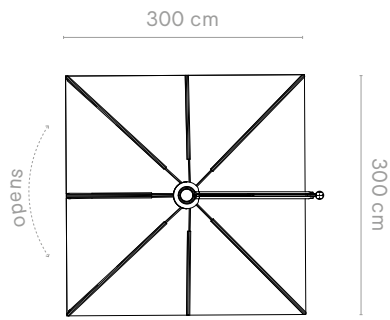

Duo square

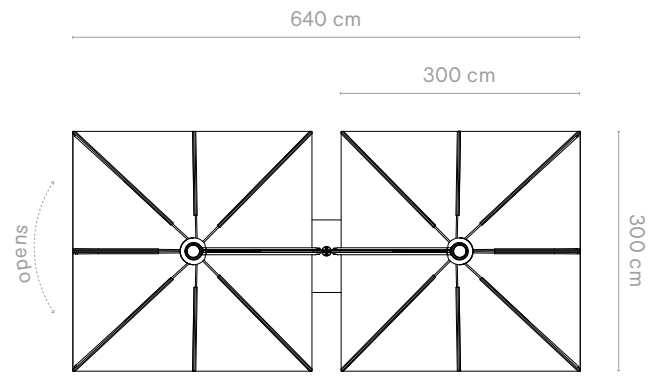

Duo diamond

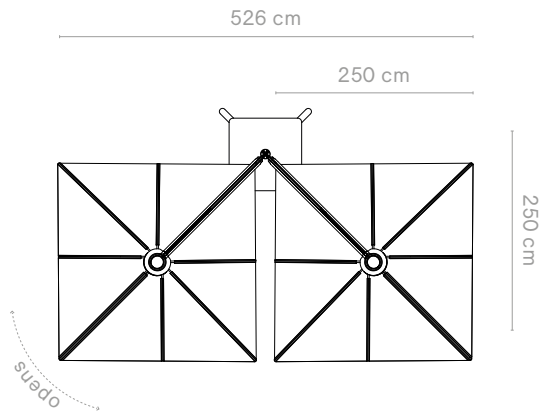

Quattro diamond

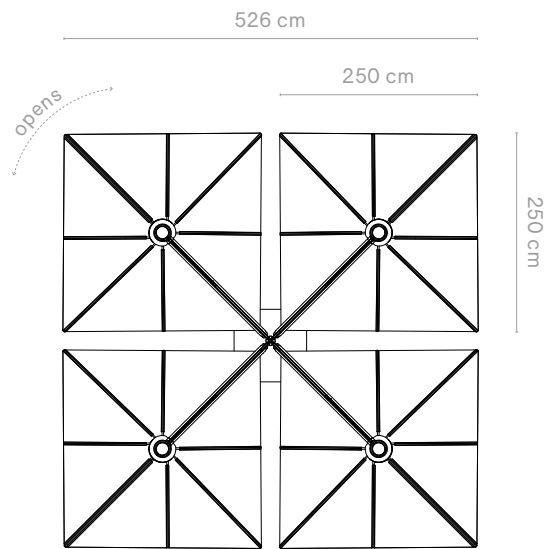

## SENSU COMBINATIONS

Single square straight - Single square tilted

Sensu single square straight +  
wheel base

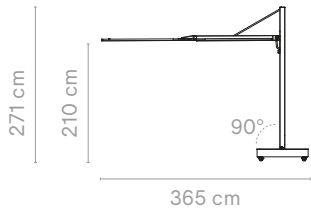

Sensu single square straight +  
permanent fixation

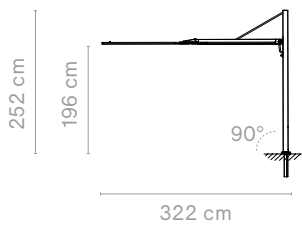

Sensu single square straight +  
permanent fixation & pole extension

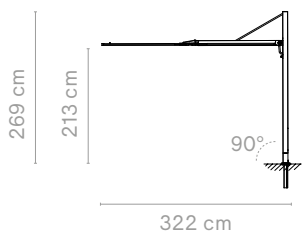

Sensu single square straight +  
floor fastening spacer plate & pole extension

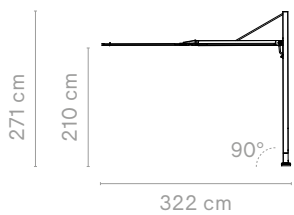

Sensu single square tilted +  
wheel base

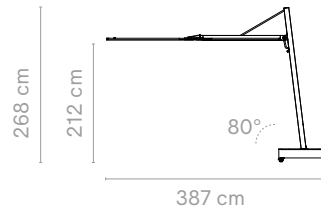

Sensu single square tilted +  
permanent fixation

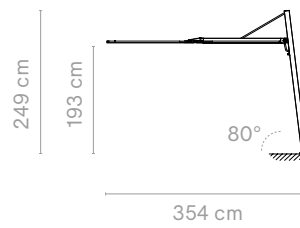

Sensu single square tilted +  
permanent fixation & pole extension

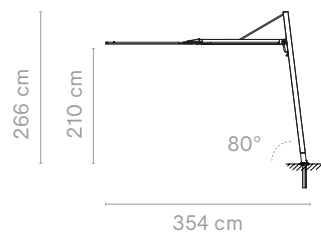

Sensu single square tilted +  
floor fastening spacer plate & pole extension

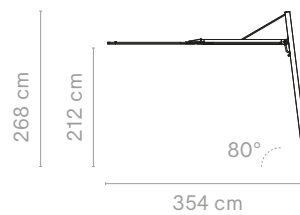

## SENSU COMBINATIONS

Duo square - Duo diamond - Quattro diamond

Sensu duo square +  
wheel base

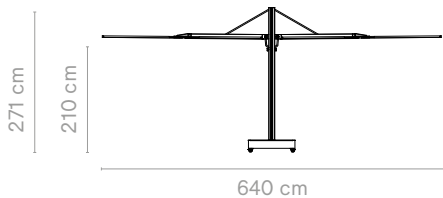

Sensu duo diamond +  
wheel base

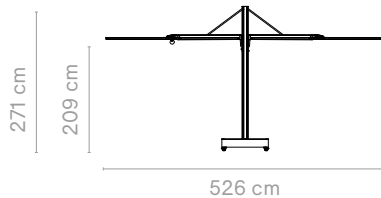

Sensu quattro diamond +  
wheel base

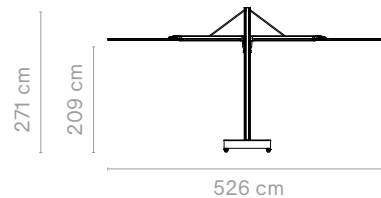

Sensu duo square +  
permanent fixation

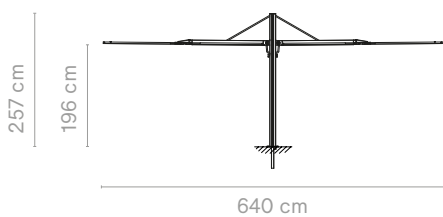

Sensu duo diamond +  
permanent fixation

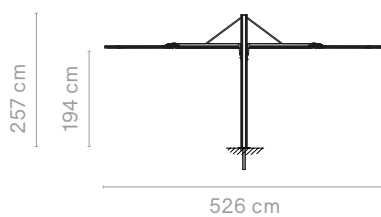

Sensu quattro diamond +  
permanent fixation

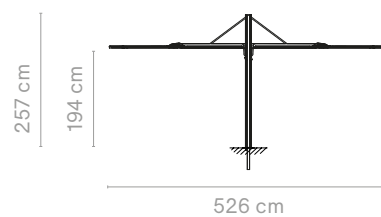

Sensu duo square +  
permanent fixation & pole extension

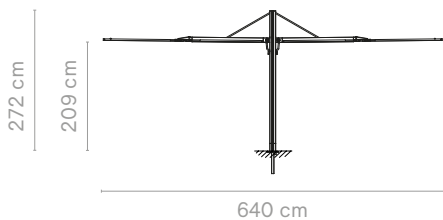

Sensu duo diamond +  
permanent fixation & pole extension

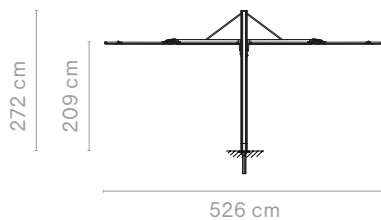

Sensu quattro diamond +  
permanent fixation & pole extension

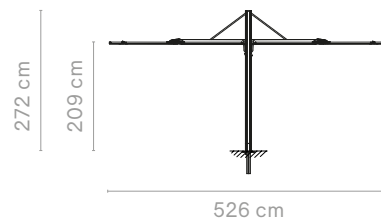

Sensu duo square +  
floor fastening

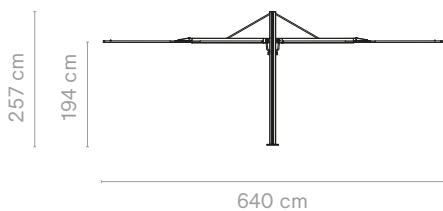

Sensu duo diamond +  
floor fastening

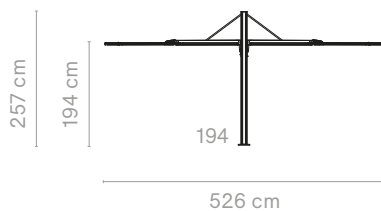

Sensu quattro diamond +  
floor fastening

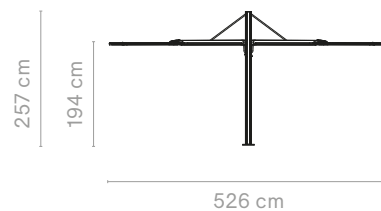

Sensu duo square +  
floor fastening & pole extension

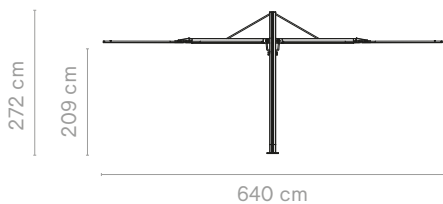

Sensu duo diamond +  
floor fastening & pole extension

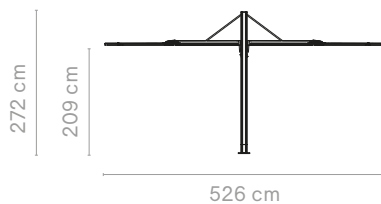

Sensu quattro diamond +  
floor fastening & pole extension

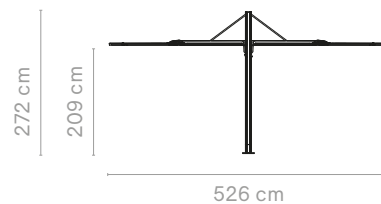

It's not a sunbed, it's not a sofa, it's both. Transform the comfortable outdoor lounge sofa into a sunbed. This multifunctionality makes Sol+Luna the perfect space-saving solution for balconies or patios. The slender sculptural frame and clean, architectural lines match the aesthetic of modern buildings, urban environments and boutique hotels. Accessories can be used to create shade, add lighting and provide surfaces for drinks. Storage accessories keep valuables safe while taking a dip in the pool.



Check availability  
www.extremis.com/portal









Shades → p129  
Recliner cush. → p129  
Comfort cush. → p130  
Bolster cushion → p131  
Wheels → p132  
Accessories → p132

## SOFA SUNBED

Outer dimensions (l x w x h): 210 x 77 x 60,5 / 35 cm

Structured powder coated aluminium frame & backrest + structured powder coated stainless steel legs + Batyline mesh

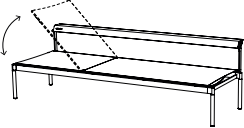
No cushions included



	 <b>BLACK</b> RAL9005 <i>Batyline: Ebony</i>	 <b>EARTH</b> RGB 88 88 84 <i>Batyline: Onyx</i>	 <b>BEACH BEIGE</b> RAL1019 <i>Batyline: Snow</i>	 <b>OFF WHITE</b> RAL9002 <i>Batyline: Snow</i>
	€ 2610 SOL006	€ 2610  SOL374	€ 2610 SOL452	€ 2610 SOL440

## TAPA TABLE

Outer dimensions (ø): 33 cm

HPL tabletop & Stainless steel support

Only compatible with the Sol+Luna plug-in system

		<b>OFF WHITE</b>	€ 300 SOL066
		<b>EARTH</b>	€ 300  SOL393
		<b>BLACK</b>	€ 300 SOL010



### Friends of the product

Deco cushions

→ p40







## PLUG-IN SHADES

High tech polyester fabric + stainless steel tube + anodized aluminium handles | Fully adjustable

Only compatible with the Sol+Luna plug-in system | Cover included

Shade + Led: In countries where this type of plug is not used, a different plug will need to be fitted

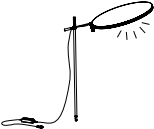
		<b>FLAT SHADE</b> ø 75 cm	<b>€ 720</b> SOL017
---	---	------------------------------	------------------------









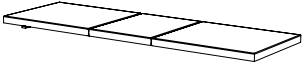

		<b>SHADE + COOL WHITE LED</b> A type E / IP67 - 4500K / ø 70 cm	<b>€ 995</b> SOL477
		<b>SHADE + WARM WHITE LED</b> A type E / IP67 - 3000K / ø 70 cm	<b>€ 995</b> SOL479

## RECLINER + SEATING CUSHIONS

Outer dimensions (l x w x t): 200 x 63 x 5 cm

Please store the cushions inside when not in use

\* Leaving the collection. Available while supplies last









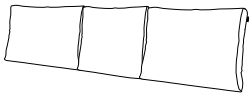

		<b>GREY CHINÉ</b> Sunbrella® Natté	<b>€ 435</b> SOL021
		<b>DARK TAUPE</b> Sunbrella® Natté	<b>€ 435</b> SOL020
		<b>COCONUT</b> Sunbrella® Savane	<b>€ 435</b> SOL403
		<b>MARBLE</b> Sunbrella® Lopi	<b>€ 560</b>  SOL338
		<b>SOOTY *</b> Sunbrella® Chartres	<b>€ 505</b> SOL024
		<b>MOSS</b> Sunbrella® Heritage	<b>€ 435</b> SOL454
		<b>COLOR ON REQUEST 1</b> Only for Sunbrella Natté, Solids, Savane & Heritage	<b>€ 465</b> SOL025
		<b>COLOR ON REQUEST 2</b> Only for Sunbrella Chartres	<b>€ 530</b> SOL346
		<b>COLOR ON REQUEST 3</b> Only for Sunbrella Lopi & Domino	<b>€ 585</b> SOL347

## COMFORT CUSHIONS

Outer dimensions (l x h x t)

Please store the cushions inside when not in use

\* Leaving the collection. Available while supplies last

		 <b>SET OF 3 SEPARATE COMFORT CUSHIONS</b> 50 x 37 x 10 cm	 <b>CONNECTED COMFORT CUSHIONS FOR 3 PEOPLE</b> 162 x 37 x 10 cm
	<b>GREY CHINÉ</b> Sunbrella® Natté	<b>€ 455</b> SOL027	<b>€ 455</b> SOL033
	<b>DARK TAUPE</b> Sunbrella® Natté	<b>€ 455</b> SOL026	<b>€ 455</b> SOL032
	<b>COCONUT</b> Sunbrella® Savane	<b>€ 470</b> SOL404	<b>€ 455</b> SOL441
	<b>MARBLE</b> Sunbrella® Lopi	<b>€ 600</b>  SOL341	<b>€ 600</b> SOL343
	<b>SOOTY *</b> Sunbrella® Chartres	<b>€ 545</b> SOL030	<b>€ 545</b> SOL036
	<b>MOSS</b> Sunbrella® Heritage	<b>€ 455</b> SOL456	<b>€ 455</b> SOL455
	<b>COLOR ON REQUEST 1</b> Only for Sunbrella Natté, Solids, Savane & Heritage	<b>€ 485</b> SOL031	<b>€ 485</b> SOL037
	<b>COLOR ON REQUEST 2</b> Only for Sunbrella Chartres	<b>€ 570</b> SOL348	<b>€ 570</b> SOL350
	<b>COLOR ON REQUEST 3</b> Only for Sunbrella Lopi & Domino	<b>€ 625</b> SOL349	<b>€ 625</b> SOL351











## BOLSTER PILLOW SET

Outer dimensions: 55 x ø 13,5 cm

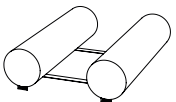
Can be connected to each other with a button



Please store the cushions inside when not in use

\* Leaving the collection. Available while supplies last

		<b>GREY CHINÉ</b> Sunbrella® Natté	<b>€ 290/set</b> SOL047
		<b>DARK TAUPE</b> Sunbrella® Natté	<b>€ 290/set</b> SOL046
		<b>COCONUT</b> Sunbrella® Savane	<b>€ 290/set</b> SOL405
		<b>MARBLE</b> Sunbrella® Lopi	<b>€ 375/set</b>  SOL344
		<b>SOOTY *</b> Sunbrella® Chartres	<b>€ 340/set</b> SOL050
		<b>MOSS</b> Sunbrella® Heritage	<b>€ 290/set</b> SOL457
		<b>COLOR ON REQUEST 1</b> Only for Sunbrella Natté, Solids, Savane & Heritage	<b>€ 315/set</b> SOL051
		<b>COLOR ON REQUEST 2</b> Only for Sunbrella Chartres	<b>€ 365/set</b> SOL352
		<b>COLOR ON REQUEST 3</b> Only for Sunbrella Lopi & Domino	<b>€ 400/set</b> SOL353

## WHEELS

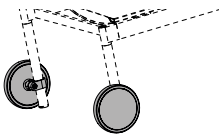
PU & powder coated aluminium cover plate

		<b>OFF WHITE</b> RAL9002	<b>€ 255/set</b> SOL065
		<b>BLACK</b> RAL9005	<b>€ 255/set</b> SOL053

## STORAGE OPTIONS

Outer dimensions (l x w)



Batyline mesh

			
		<b>STORAGE NET</b> 75 x 41 cm	<b>LOCKER</b> 36 x 32 cm
	<b>WHITE</b>	<b>€ 105</b> SOL013	<b>€ 140</b> SOL015
	<b>EARTH</b>	<b>€ 105</b> SOL378	<b>€ 140</b> SOL379
	<b>BLACK</b>	<b>€ 105</b> SOL014	<b>€ 140</b> SOL016

## COVER FOR SOFA SUNBED

When not used for a long time - for instance during winter - we recommend storing the Sol+Luna with the cover and completely dry

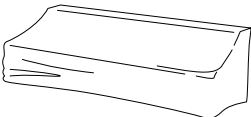
Suited for 2 stacked sofa sunbeds

	Grey PU coated polyester	<b>€ 335</b>  SOL007
---	--------------------------	--

## POOL TOWEL

Use the bright yellow Extremis pool towel on your Sol+Luna sofa sunbed, it feels very soft.

No more sliding towels, thanks to the flap that you can put over the headrest.

		<b>SUNNY YELLOW</b> 200 x 63 cm	<b>€ 50</b> SOL045
---	---	------------------------------------	-----------------------

**POPULAR FABRIC COMBINATIONS**

Numerous color combinations are possible  
 To make life easier, we have created several color combinations,  
 carefully composed following Extremis' color concepts.

Need any help finding the right color combination?  
 Go check our Biomes on page 169

**Out of the Fjordinary**  
*A boreal and montane togetherness biome*



Sol+Luna — **Black**



**Forest & Fields**  
*A green and rural togetherness biome*



Sol+Luna — **Off white**

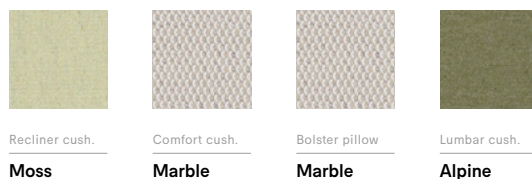

**A Lotta Terracotta** 🌿  
*A mediterranean togetherness biome*



Sol+Luna — **Earth**

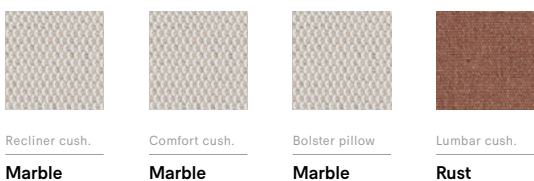

**Majestic Mirage**  
*A sandy and breezy togetherness biome*



Sol+Luna — **Beach beige**

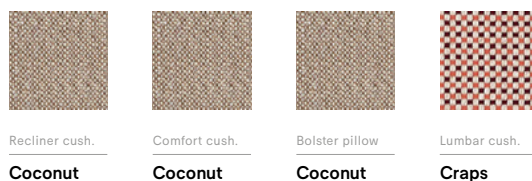

# Sticks

© design by Hsu-Li Teo & Stefan Kaiser

This space divider is ideal for creating a feeling of privacy in a garden or on a balcony without losing the sense of freedom typical of open spaces. Use Sticks indoors to adapt the look of a room or office arrangement entirely to your own taste. You can also choose which and how many rods you use and create various degrees of transparency, color combinations or differences in length. Delivered with optional feet for delicate floors. Rubber can cause stains on delicate surfaces. We recommend to use the feet if placed indoors. Use a wooden base on carpet floor.



Combine a base + rods to compose your favorite sticks.







Check availability  
[www.extremis.com/portal](http://www.extremis.com/portal)

## STANDARD BASES

Outer dimensions (l x w x h): 60 x 30 x 5 cm

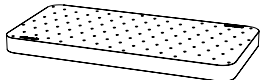

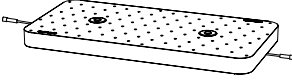
Choose rubber for outdoors/indoors or wood for indoors | Rods not included, choose rods on the next pages

		 RUBBER	 NATURAL WOOD	 DARK WOOD
	<b>STANDARD</b>	€ 180  STI076	€ 275 STI061	€ 335 STI043
	<b>COOL WHITE LEDS</b> IP65 - 6500K	€ 420 STI087	€ 515 STI075	€ 565 STI060
	<b>WARM WHITE LEDS</b> IP65 - 3000K	€ 420 STI085	€ 515 STI073	€ 565 STI058

## SHARP CURVED BASES

Outer dimensions (l x w x h): 65 x 33 x 5 cm - inner ø 2 m

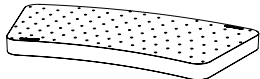
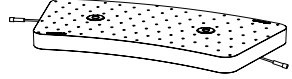

Choose rubber for outdoors/indoors or wood for indoors | Rods not included, choose rods on the next pages

		 RUBBER	 NATURAL WOOD	 DARK WOOD
	<b>STANDARD</b>	€ 215 STI077	€ 320 STI063	€ 375 STI046
	<b>COOL WHITE LEDS</b> IP65 - 6500K	€ 445 STI080	€ 550 STI067	€ 605 STI051
	<b>WARM WHITE LEDS</b> IP65 - 3000K	€ 445 STI078	€ 550 STI065	€ 605 STI048

## WIDE CURVED BASES

Outer dimensions (l x w x h): 63 x 32 x 5 cm - inner  $\varnothing$  4.30 m

Choose rubber for outdoors/indoors or wood for indoors| Rods not included, choose rods on the next pages

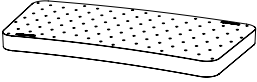
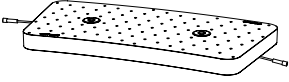
		 RUBBER	 NATURAL WOOD	 DARK WOOD
	<b>STANDARD</b>	€ 215 ST1081	€ 320 ST1068	€ 375 ST1053
	<b>COOL WHITE LEDS</b> IP65 - 6500K	€ 445 ST1084	€ 550 ST1072	€ 605 ST1057
	<b>WARM WHITE LEDS</b> IP65 - 3000K	€ 445 ST1082	€ 550 ST1070	€ 605 ST1055

### WIDE CURVED BASES

24 pieces create a complete circle of  $\varnothing$ 4,30 m

### SHARP CURVED BASES

12 pieces create a complete circle of  $\varnothing$ 2 m

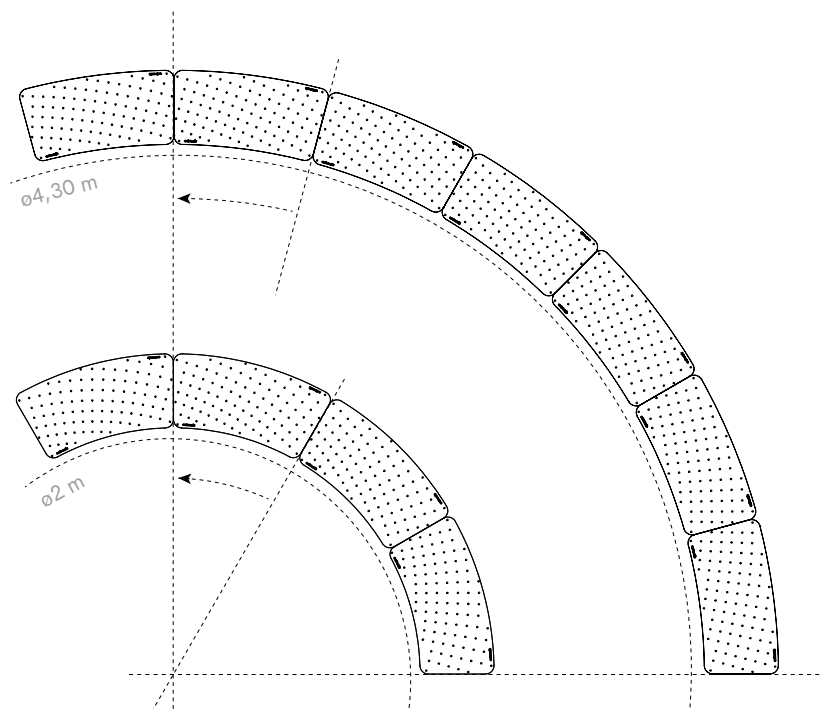









## RODS FOR STANDARD & CURVED BASES

Bases not included. Only sold with Extremis bases

Because of the specific characteristics of the production process of fiberglass, colors can only be reproduced approximately and variations may occur.

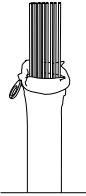
This is the case for both standard colors and custom request colors

\* Leaving the collection. Available while supplies last

	 WHITE	 BLACK	 WOOD COLOR	 GREEN *	 ON REQUEST <i>60 bases or more</i>
 120 CM	€ 310 STI011	€ 340 STI039	€ 340 STI025	€ 340 STI112	€ 390 STI113
150 CM	€ 360  STI012	€ 410 STI040	€ 410  STI026	€ 410 STI118	€ 470 STI121
180 CM	€ 440  STI013	€ 480 STI041	€ 480  STI027	€ 480 STI119	€ 550 STI122
210 CM	€ 490 STI014	€ 540 STI042	€ 540 STI028	€ 540 STI120	€ 620 STI123







## BIOPHILIC RODS FOR STANDARD & CURVED BASES

Bases not included. Only sold with Extremis bases

Because of the specific characteristics of the production process of fiberglass, colors can only be reproduced approximately and variations may occur.

This is the case for both standard colors and custom request colors

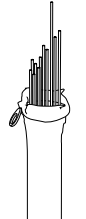
\* Leaving the collection. Available while supplies last

	 WHITE	 BLACK	 WOOD COLOR	 GREEN *
 120/ 210 CM	€ 435  STI280	€ 480 STI281	€ 480  STI282	€ 480 STI283

### STANDARD STICKS

All rods have the same height

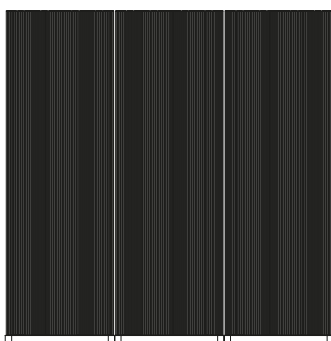

### BIOPHILIC STICKS

The rods vary in height between 120/150/180/210 cm

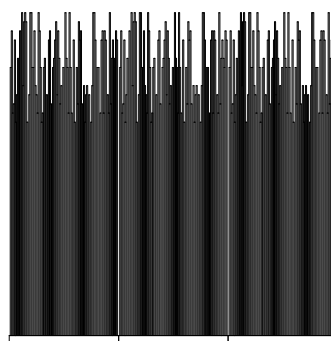



## ELECTRICAL COMPONENTS

Cord length: 150 cm

In countries where this type of plug is not used, a different plug will need to be fitted

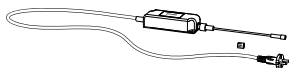

**POWER SUPPLY + STOP**  
A type B / IP44 plug is supplied  
IP65 - Up to 9 bases can be connected

**€ 145**  
STI286

## OPTIONAL CONNECTION CABLES

To leave more space between the bases

The length of the cable has an impact on the number of bases that can be connected with 1 power supply



**CONNECTION CABLE**  
IP65 - Up to 8 bases can be connected with 1 driver  
100 cm

**€ 10**  
STI139

**L CONNECTION CABLE**  
IP65 - Up to 6 bases can be connected with 1 driver  
400 cm

**€ 20**  
STI140

**XL CONNECTION CABLE**  
IP65 - Up to 4 bases can be connected with 1 driver  
900 cm

**€ 35**  
STI141

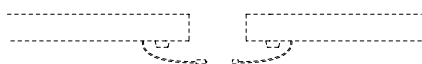

Standard connection cables  
(always included with bases with led)

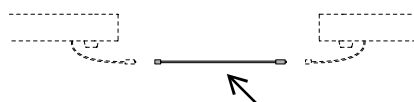

Optional connection cables  
(To leave more space between the bases)

## EXTRA WEIGHT

Galvanized steel, 1 piece

If floor fastening is not possible: extra weight for windy places

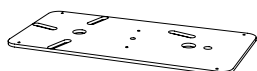

**FOR STANDARD BASES**  
10 kg/pc

**€ 125**  
STI159

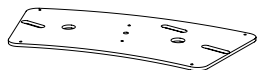

**FOR SHARP CURVED BASES**  
10 kg/pc

**€ 135**  
STI160

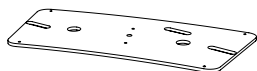

**FOR WIDE CURVED BASES**  
10 kg/pc

**€ 145**  
STI161

## CONNECTION PIECE

Can not be combined with the medium base

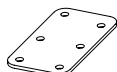

Stainless steel  
10 x 6 cm

**€ 20**  
STI146

# Tiki stools

© design by Dirk Wynants

Tiki is the ideal stool for any party, indoors or outdoors. Or why not opt for a stylish twist, with a wooden seat? With its minimalist contours, this bar stool blends seamlessly in any setting, but also emphasizes the bar itself. Tiki offers comfortable seating and support for tired feet. Even with the optional backrest, your guests have optimal freedom of movement to move to the music while sitting down. And don't worry, the optional cushion won't be blown away by the wind, because it's safely attached to the seat. Tiki is your friend even when all furniture is moved aside to make space for the dance floor - simply stack it up (8 pieces)!



Check availability  
www.extremis.com/portal













Backrests → p142  
Protective feet → p142  
Cushions → p143  
Trolley → p143

## LEGS + STRUCTURED POWDER COATED SEAT

Outer dimensions (l x w x h)

Structured powder coated zinced steel legs + Structured powder coated aluminium seat

Suitable for both indoor and outdoor use

			
	<b>STOOL</b> 39 x 41 x 45 cm	<b>COUNTER STOOL</b> 41 x 41 x 63 cm	<b>BAR STOOL</b> 41 x 41 x 74 cm
	<b>BLACK</b> RAL9005 € 275 TIK030	€ 310 TIK036	€ 320  TIK042
	<b>EARTH</b> RGB 88 88 84 € 275 TIK214	€ 310 TIK218	€ 320 TIK222
	<b>BEACH BEIGE</b> RAL1019 € 275 TIK388	€ 310 TIK433	€ 320 TIK409
	<b>OFF WHITE</b> RAL9002 € 275 TIK383	€ 310 TIK430	€ 320 TIK406
	<b>VERDIGRIS</b> RGB 133 147 142 € 275 TIK213	€ 310 TIK217	€ 320 TIK221
	<b>REED GREEN</b> RAL6013 € 275 TIK387	€ 310 TIK445	€ 320 TIK427



### Friends of the product

AMAI



→ p12

Marina  
high table



→ p98

Pantagruel  
high table



→ p114

Tiki table



→ p146











## LEGS + STRUCTURED POWDER COATED SEAT

Outer dimensions (l x w x h)

Structured powder coated zinc steel legs + Structured powder coated aluminium seat

Suitable for both indoor and outdoor use

	 <b>STOOL</b> 39 x 41 x 45 cm	 <b>COUNTER STOOL</b> 41 x 41 x 63 cm	 <b>BAR STOOL</b> 41 x 41 x 74 cm
 <b>COPPER BROWN</b> RAL8004	<b>€ 275</b> TIK326	<b>€ 310</b> TIK325	<b>€ 320</b> TIK074
 <b>COSMIC CREAM</b> RAL1015	<b>€ 275</b> TIK372	<b>€ 310</b> TIK394	<b>€ 320</b> TIK397
 <b>COBALT BLUE</b> RAL5013	<b>€ 305</b> TIK386	<b>€ 340</b> TIK439	<b>€ 350</b> TIK424
 <b>SUN YELLOW</b> RAL1032	<b>€ 305</b> TIK384	<b>€ 340</b> TIK436	<b>€ 350</b> TIK418
 <b>PISTACHE</b> RAL6021	<b>€ 305</b> TIK385	<b>€ 340</b> TIK442	<b>€ 350</b> TIK421
 <b>ON REQUEST</b> Only RAL colors Startup fee € 300 (ex. VAT)	<b>€ 345</b> TIK034	<b>€ 390</b> TIK040	<b>€ 400</b> TIK046











## LEGS + OILED OAK SEAT

Outer dimensions (l x w x h)

Structured powder coated zinced steel legs + Oiled oak seat

The oak seat is for indoor use only | Can not be combined with cushions

		 <b>STOOL</b> <i>39 x 41 x 45 cm</i>	 <b>COUNTER STOOL</b> <i>41 x 41 x 63 cm</i>	 <b>BAR STOOL</b> <i>41 x 41 x 74 cm</i>
	<b>BLACK</b> RAL9005	€ 370 TIK031	€ 405 TIK037	€ 415 TIK043
	<b>EARTH</b> RGB 88 88 84	€ 370 TIK216	€ 405 TIK220	€ 415 TIK224
	<b>BEACH BEIGE</b> RAL1019	€ 370 TIK410	€ 405 TIK447	€ 415 TIK453
	<b>OFF WHITE</b> RAL9002	€ 370 TIK411	€ 405 TIK448	€ 415 TIK454
	<b>VERDIGRIS</b> RGB 133 147 142	€ 370 TIK215	€ 405 TIK219	€ 415 TIK223
	<b>REED GREEN</b> RAL6013	€ 370 TIK415	€ 405 TIK452	€ 415 TIK459











## LEGS + OILED OAK SEAT

Outer dimensions (l x w x h)

Structured powder coated zinc steel legs + Oiled oak seat













The oak seat is for indoor use only | Can not be combined with cushions

	 <b>STOOL</b> 39 x 41 x 45 cm	 <b>COUNTER STOOL</b> 41 x 41 x 63 cm	 <b>BAR STOOL</b> 41 x 41 x 74 cm
 <b>COPPER BROWN</b> RAL8004	<b>€ 370</b> TIK329	<b>€ 405</b> TIK328	<b>€ 415</b> TIK327
 <b>COSMIC CREAM</b> RAL1015	<b>€ 370</b> TIK391	<b>€ 405</b> TIK446	<b>€ 415</b> TIK455
 <b>COBALT BLUE</b> RAL5013	<b>€ 390</b> TIK414	<b>€ 425</b> TIK450	<b>€ 435</b> TIK457
 <b>SUN YELLOW</b> RAL1032	<b>€ 390</b> TIK412	<b>€ 425</b> TIK449	<b>€ 435</b> TIK456
 <b>PISTACHE</b> RAL6021	<b>€ 390</b> TIK413	<b>€ 425</b> TIK451	<b>€ 435</b> TIK458
 <b>ON REQUEST</b> Only RAL colors Startup fee € 300 (ex. VAT)	<b>€ 415</b> TIK035	<b>€ 460</b> TIK041	<b>€ 470</b> TIK047

## BACKREST

Structured powder coated stainless steel | 1 piece

Suitable for both powder coated & oak seat

	<b>BLACK</b> RAL9005	<b>€ 125</b> TIK020
	<b>EARTH</b> RGB 88 88 84	<b>€ 125</b> TIK226
	<b>BEACH BEIGE</b> RAL1019	<b>€ 125</b> TIK401
	<b>OFF WHITE</b> RAL9002	<b>€ 125</b> TIK461
	<b>VERDIGRIS</b> RGB 133 147 142	<b>€ 125</b> TIK225
	<b>REED GREEN</b> RAL6013	<b>€ 125</b> TIK467
	<b>COPPER BROWN</b> RAL8004	<b>€ 125</b> TIK323
	<b>COSMIC CREAM</b> RAL1015	<b>€ 125</b> TIK403
	<b>COBALT BLUE</b> RAL5013	<b>€ 145</b> TIK463
	<b>SUN YELLOW</b> RAL1032	<b>€ 145</b> TIK402
	<b>PISTACHE</b> RAL6021	<b>€ 145</b> TIK465
	<b>COLOR ON REQUEST</b> Only RAL colors Startup fee € 300 (ex. VAT)	<b>€ 145</b> TIK022

## PROTECTION FEET WITH FELT

For delicate floors

Stacking is not recommended due the risk of damaging the powder coating











	<b>FELT</b> 1 set: 4 pieces	<b>€ 15/set</b> TIK189
---	--------------------------------	---------------------------

## CUSHIONS

Outer dimensions (ø x h): 34 x 1,5 cm - 1 piece

Please store the cushions inside when not in use

\* Leaving the collection. Available while supplies last



		<b>GREY CHINÉ</b> Sunbrella® Natté	<b>€ 100</b> VRS757
		<b>DARK TAUPE</b> Sunbrella® Natté	<b>€ 100</b> VRS758
		<b>MARBLE</b> Sunbrella® Lopi	<b>€ 120</b>  VRS756
		<b>CHARCOAL</b> Sunbrella® Lopi	<b>€ 120</b> VRS755
		<b>LEAF GREEN</b> Sunbrella® Heritage	<b>€ 100</b> VRS761
		<b>INDIGO *</b> Sunbrella® Heritage	<b>€ 100</b> VRS762
		<b>LOTO *</b> Sunbrella® Domino	<b>€ 120</b> VRS760
		<b>CRAPS *</b> Sunbrella® Domino	<b>€ 120</b> VRS759

## TIKI STOOL TROLLEY

Outer dimensions (l x w x h): 63 x 41 x 162 cm

Galvanized steel trolley with protection for safe, scratch-free transport | Suitable for outdoor use

Possible to store 12 Tiki stools, counter stools or bar stools (with our without backrests)

		<b>GALVANIZED STEEL</b>	<b>€ 595</b> TIK099
---	---	-------------------------	------------------------

## STORAGE BAG FOR TIKI STOOL TROLLEY

Outer dimensions (l x w x h): 45 x 28 x 41 cm

Batyline mesh - Perfect to store your cushions

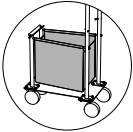
		<b>BLACK</b>	<b>€ 120</b> TIK100
---	---	--------------	------------------------

## HOW TO COMBINE TIKI STOOLS?

With Tiki Stool Trolley, Tiki table & AMAi

Tiki Stool Trolley +  
12 x Tiki stools (powder coated seat)

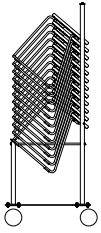

€ 3895

Tiki Stool Trolley +  
12 x Tiki bar stool (powder coated seat)

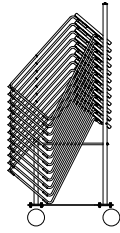

€ 4435

Tiki Stool Trolley +  
12 x Tiki bar stool (powder coated seat) +  
12 x backrest

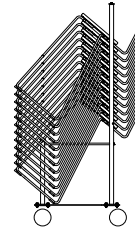

€ 5935

3 x Tiki bar stool (powder coated seat) +  
Tiki table small

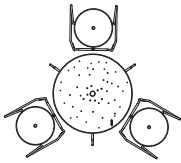

€ 1940

5 x Tiki bar stool (powder coated seat) +  
Tiki table large

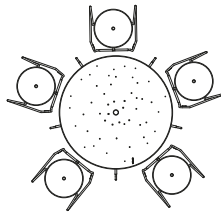

€ 3045

4 x Tiki bar stool (powder coated seat) +  
AMAi catering station

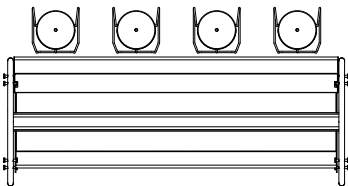

€ 7570

8 x Tiki bar stool (powder coated seat) +  
AMAi base module (powder coated) & extension module +  
4 x AMAi HiLo bench

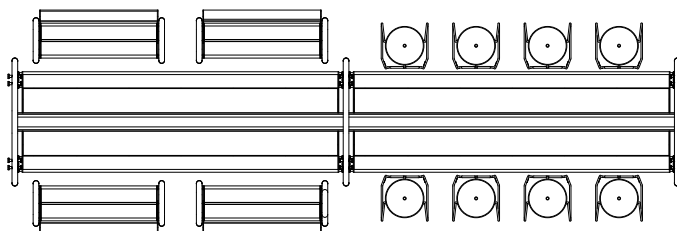

€ 18535



## HOW TO COMBINE TIKI STOOLS?

With Panigiri, Pantagruel high table & Marina high table

4 x Tiki stool (powder coated seat) +  
Panigiri combo base module

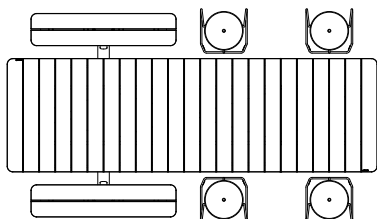

€ 8375

4 x Tiki stool (powder coated seat) +  
Panigiri combo base module + Panigiri additional picnic module

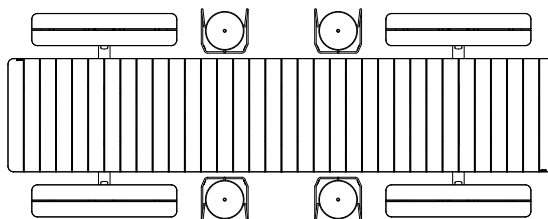

€ 12700

8 x Tiki bar stool (powder coated seat) +  
Pantagruel high table (Hellwood)

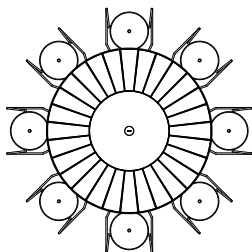

€ 7110

4 x Tiki bar stool (powder coated seat) +  
4 x Captain's Chairs high sliding + Pantagruel high table (Hellwood)

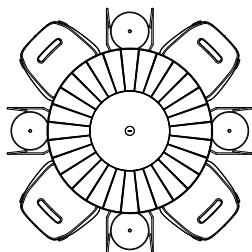

€ 7850

4 x Tiki bar stool (powder coated seat) +  
Marina high table 195 cm (5 profiles)

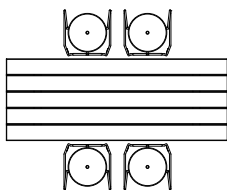

€ 3680

6 x Tiki bar stool (powder coated seat) +  
Marina high table 265 cm (5 profiles)

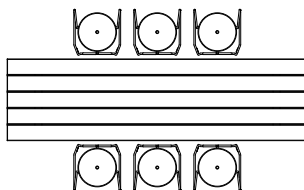

€ 4900

10 x Tiki bar stool (powder coated seat) +  
Marina high table 335 cm (5 profiles)

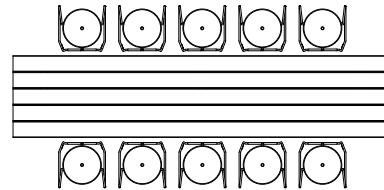

€ 6780

# Tiki table

© design by Dirk Wynants

Tiki table is sophisticated, weather-proof, functional, and ready to back your cocktail moment. Rest tired feet on the bent steel legs. The light, dainty aesthetic should not be underestimated as the durability of the design is ensured by a strong, wire-frame base made up of outdoor-resistant materials. But what really distinguishes this table is its foldable, compact design. Just take off the tabletop and fold in the legs when it's time to hit the dancefloor.

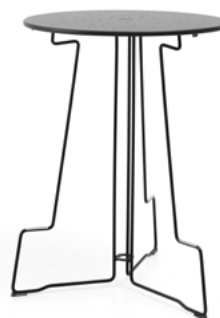

Check availability  
www.extremis.com/portal



Trolley → p147











ø41 mm

## STANDARD TABLETOP WITH DRAINAGE HOLES & PARASOL HOLE

Outer dimensions (ø x h)

Structured powder coated ZnAlMg tabletop + structured powder coated zinc steel legs

The frame is equipped with a purse hanger on each leg

		 <b>SMALL</b> ø90 x 105 cm Tabletop ø80 cm	 <b>LARGE</b> ø110 x 105 cm Tabletop ø100 cm
	<b>BLACK</b> RAL9005	€ 980  TIK093	€ 1445 TIK075
	<b>EARTH</b> RGB 88 88 84	€ 980 TIK094	€ 1445 TIK076
	<b>OFF WHITE</b> RAL9002	€ 980 TIK095	€ 1445 TIK077
	<b>VERDIGRIS</b> RGB 133 147 142	€ 980 TIK096	€ 1445 TIK078
	<b>COPPER BROWN</b> RAL8004	€ 980 TIK097	€ 1445 TIK079
	<b>COLOR ON REQUEST</b> Only RAL colors Startup fee € 300 (ex. VAT)	€ 1125 TIK098	€ 1660 TIK080



### Friends of the product

Tiki  
bar stool











→ p138

## SOLID TABLETOP, NO PARASOL HOLE

Outer dimensions (ø x h)

Structured powder coated ZnAlMg tabletop + structured powder coated zinc steel legs

The frame is equipped with a purse hanger on each leg



		 <b>SMALL</b> ø90 x 105 cm Tabletop ø80 cm	 <b>LARGE</b> ø110 x 105 cm Tabletop ø100 cm
	<b>BLACK</b> RAL9005	€ 980 TIK087	€ 1445 TIK081
	<b>EARTH</b> RGB 88 88 84	€ 980 TIK088	€ 1445 TIK082
	<b>OFF WHITE</b> RAL9002	€ 980 TIK089	€ 1445 TIK083
	<b>VERDIGRIS</b> RGB 133 147 142	€ 980 TIK090	€ 1445 TIK084
	<b>COPPER BROWN</b> RAL8004	€ 980 TIK091	€ 1445 TIK085
	<b>COLOR ON REQUEST</b> Only RAL colors Startup fee € 300 (ex. VAT)	€ 1125 TIK092	€ 1660 TIK086

## TIKI TABLE TROLLEY

Outer dimensions (l x w x h): 69 x 75 x 123 cm

Galvanized steel trolley with protection for safe, scratch-free transport + Black fiberglass rods | Suitable for outdoor use

Possible to store 8 small Tiki tables / 4 large Tiki tables or 4 small and 2 large Tiki tables combined

		<b>GALVANIZED STEEL</b>	€ 995 TIK101
---	---	-------------------------	-----------------

## HOW TO COMBINE TIKI TABLES

with the Tiki Table Trolley

Tiki Table Trolley +  
8 x small Tiki tables

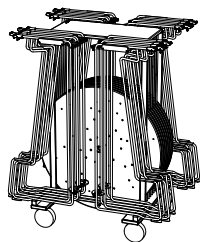

€ 8835

Tiki Table Trolley +  
4 x large Tiki tables

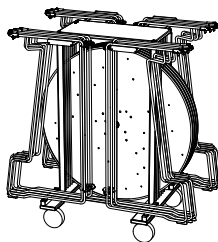

€ 6775

Tiki Table Trolley +  
4 x small Tiki tables + 2 x large Tiki tables

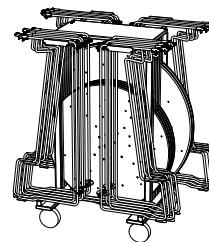

€ 7805



Virus brings life to even the most sterile places. When you look at it from above, you can see its round shape with variously shaped arms. The compact design is an answer to smaller living spaces and makes it perfect to use on balconies, in urban gardens or in breakout spaces in offices or schools. There is a Virus picnic table fit for any need. Our aim? Togetherness, anywhere.



Add the included rubber ring to nicely fit your Acacia parasol.

 Check availability  
www.extremis.com/portal















 Wheelchair accessible  
→ p176

 Backrests → p150  
 Floor fastening → p150  
 Cushions → p151

 ø41 mm

## STANDARD TABLETOP WITH DRAINAGE HOLES & PARASOL HOLE













Structured powder coated ZnAlMg tabletop, aluminium seats & stainless steel legs  
Suitable for both outdoor and indoor use

	 <b>3-SEATER</b> ø160 x 75 cm Tabletop ø80 cm	 <b>4-SEATER</b> ø170 x 75 cm Tabletop ø90 cm	 <b>5-SEATER</b> ø180 x 75 cm Tabletop ø100 cm
 <b>OFF WHITE</b> RAL9002	€ 1700 VRS842	€ 2100 VRS870	€ 2510 VRS885
 <b>VERDIGRIS</b> RGB 133 147 142	€ 1700 VRS019	€ 2100 VRS018	€ 2510 VRS017
 <b>REED GREEN</b> RAL6013	€ 1700  VRS003	€ 2100  VRS002	€ 2510  VRS001
 <b>COPPER BROWN</b> RAL8004	€ 1700 VRS027	€ 2100 VRS026	€ 2510 VRS025
 <b>COSMIC CREAM</b> RAL1015	€ 1700 VRS856	€ 2100 VRS872	€ 2510 VRS887
 <b>COBALT BLUE</b> RAL5013	€ 1870 VRS043	€ 2320 VRS042	€ 2775 VRS041
 <b>SUN YELLOW</b> RAL1032	€ 1870 VRS855	€ 2320 VRS871	€ 2775 VRS886
 <b>PISTACHE</b> RAL6021	€ 1870 VRS857	€ 2320 VRS873	€ 2775 VRS888
 <b>ON REQUEST</b> Only RAL colors Startup fee € 300 (ex. VAT)	€ 2150 VRS067	€ 2665 VRS066	€ 3190 VRS065













### SOLID TABLETOP, NO PARASOL HOLE

Structured powder coated ZnAlMg tabletop, aluminium seats & stainless steel legs  
Suitable for both outdoor and indoor use

	 <b>3-SEATER</b> ø160 x 75 cm Tabletop ø80 cm	 <b>4-SEATER</b> ø170 x 75 cm Tabletop ø90 cm	 <b>5-SEATER</b> ø180 x 75 cm Tabletop ø100 cm
 <b>OFF WHITE</b> RAL9002	<b>€ 1680</b> VRS897	<b>€ 2080</b> VRS909	<b>€ 2485</b> VRS920
 <b>VERDIGRIS</b> RGB 133 147 142	<b>€ 1680</b> VRS528	<b>€ 2080</b> VRS529	<b>€ 2485</b> VRS530
 <b>REED GREEN</b> RAL6013	<b>€ 1680</b> VRS532	<b>€ 2080</b> VRS533	<b>€ 2485</b> VRS534
 <b>COPPER BROWN</b> RAL8004	<b>€ 1680</b> VRS536	<b>€ 2080</b> VRS537	<b>€ 2485</b> VRS538
 <b>COSMIC CREAM</b> RAL1015	<b>€ 1680</b> VRS899	<b>€ 2080</b> VRS911	<b>€ 2485</b> VRS922
 <b>COBALT BLUE</b> RAL5013	<b>€ 1850</b> VRS544	<b>€ 2290</b> VRS545	<b>€ 2745</b> VRS546
 <b>SUN YELLOW</b> RAL1032	<b>€ 1850</b> VRS898	<b>€ 2290</b> VRS910	<b>€ 2745</b> VRS921
 <b>PISTACHE</b> RAL6021	<b>€ 1850</b> VRS900	<b>€ 2290</b> VRS912	<b>€ 2745</b> VRS923
 <b>ON REQUEST</b> Only RAL colors Startup fee € 300 (ex. VAT)	<b>€ 2130</b> VRS556	<b>€ 2635</b> VRS557	<b>€ 3155</b> VRS558

## BACKRESTS

Structured powder coated zinc steel - 1 piece

		<b>OFF WHITE</b> RAL9002	<b>€ 180</b> VRS924
		<b>VERDIGRIS</b> RGB 133 147 142	<b>€ 180</b> VRS074
		<b>REED GREEN</b> RAL6013	<b>€ 180</b> VRS075
		<b>COPPER BROWN</b> RAL8004	<b>€ 180</b> VRS076
		<b>COSMIC CREAM</b> RAL1015	<b>€ 180</b> VRS926
		<b>COBALT BLUE</b> RAL5013	<b>€ 205</b> VRS078
		<b>SUN YELLOW</b> RAL1032	<b>€ 205</b> VRS925
		<b>PISTACHE</b> RAL6021	<b>€ 205</b> VRS927
	<b>COLOR ON REQUEST</b> Only RAL colors Startup fee € 300 (ex. VAT)	<b>€ 235</b> VRS081	

## FLOOR FASTENING

You need 1 piece for every seat

	Stainless steel	<b>€ 30/pc</b> VRS082
---	-----------------	--------------------------

## STACKING SPACER & PURSE HANGER

You need 1 piece for every leg

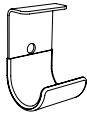
	Stainless steel with rubber cover	<b>€ 30/pc</b> VRS673
---	-----------------------------------	--------------------------



### Friends of the product

Acacia

→ p10













## CUSHIONS

Outer dimensions (ø x h): 34 x 1,5 cm - 1 piece

Please store the cushions inside when not in use

\* Leaving the collection. Available while supplies last

		<b>GREY CHINÉ</b> Sunbrella® Natté	<b>€ 100</b> VRS757
		<b>DARK TAUPE</b> Sunbrella® Natté	<b>€ 100</b> VRS758
		<b>MARBLE</b> Sunbrella® Lopi	<b>€ 120</b>  VRS756
		<b>CHARCOAL</b> Sunbrella® Lopi	<b>€ 120</b> VRS755
		<b>LEAF GREEN</b> Sunbrella® Heritage	<b>€ 100</b> VRS761
		<b>INDIGO *</b> Sunbrella® Heritage	<b>€ 100</b> VRS762
		<b>LOTO *</b> Sunbrella® Domino	<b>€ 120</b> VRS760
		<b>CRAPS *</b> Sunbrella® Domino	<b>€ 120</b> VRS759

## VIRUS COMBINATIONS

With Acacia

Virus 3-seater (standard tabletop) +  
Acacia with lightweight parasol base



**€ 3935**

Virus 4-seater (standard tabletop) +  
Acacia with lightweight parasol base



**€ 4335**

Virus 5-seater (standard tabletop) +  
Acacia with lightweight parasol base

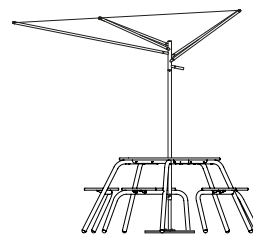

**€ 4745**

# Walrus

© design by Dirk Wynants

Walrus is a true innovation, as a super robust cover material is used to make a sleek, weatherproof sofa that always looks great. An ingenious storage pouch in the back of the Walrus hides a foldout blanket and cushions to provide softness and comfort. This softness is provided in a matter of seconds: a warm, dry and comfortable place to sit outdoors is instantly available as soon as the sun comes out. Yes, in all seasons!



Check availability  
www.extremis.com/portal



Blankets → p156  
Comfort cushions → p157  
Deco cushions → p158  
Footstool → p160  
Tables → p160  
Feet → p160







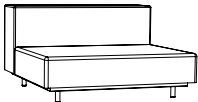

## MODULES WITH 110 CM WIDE SEATING

Outer dimensions (l x w x h) | Standard seating height: 32,5 cm

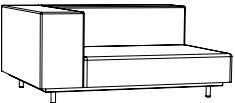
Morbern Sundance upholstery + galvanized steel frame & feet (standard galvanized feet are included)

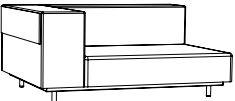
Each Walrus module contains one comfort cushion filling

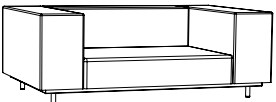
Ordering a comfort cushion cover and blanket per module is mandatory

		CHALK	SAFARI	EARTH
	<b>MIDDLE SEAT</b> With 1 storage pouch 110 x 110 x 60,5 cm	€ 2340 WAL319	€ 2340  WAL317	€ 2340 WAL508
	<b>CORNER SEAT (L/R)</b> With 1 storage pouch 140 x 110 x 60,5 cm	€ 3350 WAL314	€ 3350  WAL315	€ 3350 WAL509
	<b>CORNER SEAT (L/R) + EXTRA STORAGE POUCH</b> With 2 storage pouches 140 x 110 x 60,5 cm	€ 3895 WAL320	€ 3895  WAL321	€ 3895 WAL510
	<b>CLUB CHAIR</b> With 1 storage pouch 170 x 110 x 60,5 cm	€ 4370 WAL322	€ 4370  WAL323	€ 4370 WAL511

## CONNECTION PIECE

Attach two frames together

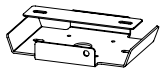

Galvanized steel  
23 x 17 x 3,3 cm

€ 50   
WAL158



## Friends of the product

Kosmos shade square

→ p81



Sensu

→ p118















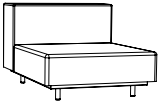

### MODULES WITH 80 CM WIDE SEATING

Outer dimensions (l x w x h) | Standard seating height: 32,5 cm

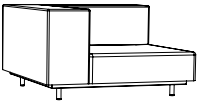
Morbern Sundance upholstery + galvanized steel frame & feet (standard galvanized feet are included)

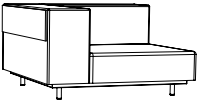
Each Walrus module contains one comfort cushion filling

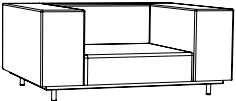
Ordering a comfort cushion cover and blanket per module is mandatory

		 CHALK	 SAFARI	 EARTH
	<b>MIDDLE SEAT</b> With 1 storage pouch 80 x 110 x 60,5 cm	<b>€ 1775</b> WAL326	<b>€ 1775</b>  WAL327	<b>€ 1775</b> WAL513
	<b>CORNER SEAT (L/R)</b> With 1 storage pouch 110 x 110 x 60,5 cm	<b>€ 2830</b> WAL318	<b>€ 2830</b>  WAL316	<b>€ 2830</b> WAL514
	<b>CORNER SEAT (L/R) + EXTRA STORAGE POUCH</b> With 2 storage pouches 110 x 110 x 60,5 cm	<b>€ 3375</b> WAL328	<b>€ 3375</b>  WAL329	<b>€ 3375</b> WAL515
	<b>CLUB CHAIR</b> With 1 storage pouch 140 x 110 x 60,5 cm	<b>€ 3840</b> WAL330	<b>€ 3840</b>  WAL331	<b>€ 3840</b> WAL516

### COMFORT CUSHION FILLING

Outer dimensions (l x w x t): 90 x 50 x 20 cm

Each Walrus module comes with one comfort cushion filling, included in its storage pouch. If you'd like to order an additional cushion, please remember to order an extra filling

	<b>110 - COMFORT CUSHION FILLING</b>	<b>€ 50</b> WAL448
---	--------------------------------------	-----------------------

	<b>80 - COMFORT CUSHION FILLING</b>	<b>€ 50</b> WAL449
---	-------------------------------------	-----------------------















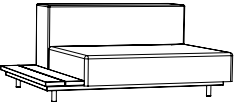

### SIDE TABLE MODULES WITH 110 CM WIDE SEATING

Outer dimensions (l x w x h) | Standard seating height: 32,5 cm

Morbern Sundance upholstery + galvanized steel frame & feet (standard galvanized feet are included) | Hellwood = 100% PEFC

Each Walrus module contains one comfort cushion filling

Ordering a comfort cushion cover and blanket per module is mandatory

				
		CHALK	SAFARI	EARTH
	 <b>SEAT WITH SIDE TABLE (L/R)</b> <b>HELLWOOD</b> With 1 storage pouch 137,5 x 110 x 60,5 cm	€ 2720 WAL334	€ 2720  WAL335	€ 2720 WAL518
	 <b>SEAT WITH SIDE TABLE (L/R)</b> <b>IROKO</b> With 1 storage pouch 137,5 x 110 x 60,5 cm	€ 2805 WAL332	€ 2805 WAL333	€ 2805 WAL517
	 <b>CORNER SEAT (L/R) + SIDE TABLE</b> <b>HELLWOOD</b> With 1 storage pouch 167,5 x 110 x 60,5 cm	€ 3740 WAL338	€ 3740  WAL339	€ 3740 WAL520
	 <b>CORNER SEAT (L/R) + SIDE TABLE</b> <b>IROKO</b> With 1 storage pouch 167,5 x 110 x 60,5 cm	€ 3825 WAL336	€ 3825 WAL337	€ 3825 WAL519
	 <b>SEAT WITH 2 SIDE TABLES</b> <b>HELLWOOD</b> With 1 storage pouch 165 x 110 x 60,5 cm	€ 3110 WAL342	€ 3110  WAL343	€ 3110 WAL522
	 <b>SEAT WITH 2 SIDE TABLES</b> <b>IROKO</b> With 1 storage pouch 165 x 110 x 60,5 cm	€ 3280 WAL340	€ 3280 WAL341	€ 3280 WAL521















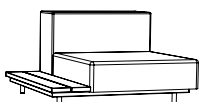

**SIDE TABLE MODULES WITH 80 CM WIDE SEATING**

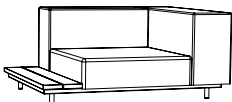
Outer dimensions (l x w x h) | Standard seating height: 32,5 cm

Morbern Sundance upholstery + galvanized steel frame & feet (standard galvanized feet are included) | Hellwood = 100% PEFC

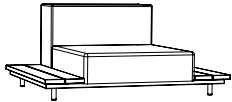
Each Walrus module contains one comfort cushion filling











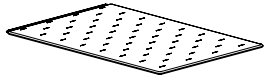
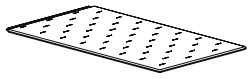



Ordering a comfort cushion cover and blanket per module is mandatory

		 <b>CHALK</b>	 <b>SAFARI</b>	 <b>EARTH</b>
	  <p><b>SEAT WITH SIDE TABLE (L/R)</b>  <b>HELLWOOD</b>            With 1 storage pouch            107,5 x 110 x 60,5 cm</p>	<p>€ 2200 WAL346</p>	<p>€ 2200  WAL347</p>	<p>€ 2200 WAL524</p>
	 <p><b>SEAT WITH SIDE TABLE (L/R)</b>  <b>IROKO</b>            With 1 storage pouch            107,5 x 110 x 60,5 cm</p>	<p>€ 2285 WAL344</p>	<p>€ 2285 WAL345</p>	<p>€ 2285 WAL523</p>
	  <p><b>CORNER SEAT (L/R) + SIDE TABLE</b>  <b>HELLWOOD</b>            With 1 storage pouch            137,5 x 110 x 60,5 cm</p>	<p>€ 3210 WAL350</p>	<p>€ 3210  WAL351</p>	<p>€ 3210 WAL526</p>
	 <p><b>CORNER SEAT (L/R) + SIDE TABLE</b>  <b>IROKO</b>            With 1 storage pouch            137,5 x 110 x 60,5 cm</p>	<p>€ 3295 WAL348</p>	<p>€ 3295 WAL349</p>	<p>€ 3295 WAL525</p>
	  <p><b>SEAT WITH 2 SIDE TABLES</b>  <b>HELLWOOD</b>            With 1 storage pouch            135 x 110 x 60,5 cm</p>	<p>€ 2600 WAL354</p>	<p>€ 2600  WAL355</p>	<p>€ 2600 WAL528</p>
	 <p><b>SEAT WITH 2 SIDE TABLES</b>  <b>IROKO</b>            With 1 storage pouch            135 x 110 x 60,5 cm</p>	<p>€ 2770 WAL352</p>	<p>€ 2770 WAL353</p>	<p>€ 2770 WAL527</p>

## BLANKETS

Outer dimensions (l x w x t)

Ordering a blanket per module is mandatory

		 <b>110 - BLANKET</b> <i>157 x 105 x 2 cm</i> <i>For 110 cm seating</i>	 <b>80 - BLANKET</b> <i>157 x 75 x 2 cm</i> <i>For 80 cm seating</i>
	<b>GREY CHINÉ</b> Sunbrella® Natté	<b>€ 350</b> WAL075	<b>€ 285</b> WAL087
	<b>DARK TAUPE</b> Sunbrella® Natté	<b>€ 350</b> WAL074	<b>€ 285</b> WAL086
	<b>COCONUT</b> Sunbrella® Savane	<b>€ 350</b>  WAL356	<b>€ 285</b>  WAL363
	<b>MARBLE</b> Sunbrella® Lopi	<b>€ 475</b>  WAL357	<b>€ 400</b>  WAL364
	<b>CHARCOAL</b> Sunbrella® Lopi	<b>€ 475</b> WAL358	<b>€ 400</b> WAL365
	<b>LEAF GREEN</b> Sunbrella® Heritage	<b>€ 350</b> WAL083	<b>€ 285</b> WAL095
	<b>RUST</b> Sunbrella® Heritage	<b>€ 350</b> WAL361	<b>€ 285</b> WAL368
	<b>COLOR ON REQUEST 1</b> Only for Sunbrella Natté, Solids, Savane & Heritage	<b>€ 375</b> WAL085	<b>€ 310</b> WAL097
	<b>COLOR ON REQUEST 2</b> Only for Sunbrella Chartres	<b>€ 435</b> WAL432	<b>€ 370</b> WAL434
	<b>COLOR ON REQUEST 3</b> Only for Sunbrella Lopi & Domino	<b>€ 500</b> WAL433	<b>€ 425</b> WAL435











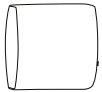

## COMFORT CUSHIONS

Outer dimensions (l x w x t)

Each Walrus module contains one comfort cushion filling

Ordering a comfort cushion cover per module is mandatory

\* Leaving the collection. Available while supplies last











		 <b>110 - COMFORT CUSHION</b> 90 x 50 x 20 cm For 110 cm seating	 <b>80 - COMFORT CUSHION</b> 60 x 50 x 20 cm For 80 cm seating
	<b>GREY CHINÉ</b> Sunbrella® Natté	<b>€ 185</b> WAL442	<b>€ 125</b> WAL443
	<b>DARK TAUPE</b> Sunbrella® Natté	<b>€ 185</b> WAL373	<b>€ 125</b> WAL386
	<b>COCONUT</b> Sunbrella® Savane	<b>€ 185</b> WAL370	<b>€ 125</b> WAL383
	<b>MARBLE</b> Sunbrella® Lopi	<b>€ 235</b> 🌿 WAL371	<b>€ 170</b> 🌿 WAL384
	<b>CHARCOAL</b> Sunbrella® Lopi	<b>€ 235</b> WAL372	<b>€ 170</b> WAL385
	<b>LEAF GREEN</b> Sunbrella® Heritage	<b>€ 185</b> WAL376	<b>€ 125</b> WAL389
	<b>INDIGO *</b> Sunbrella® Heritage	<b>€ 185</b> 🌿 WAL379	<b>€ 125</b> 🌿 WAL392
	<b>RUST</b> Sunbrella® Heritage	<b>€ 185</b> WAL377	<b>€ 125</b> WAL390
	<b>COLOR ON REQUEST 1</b> Only for Sunbrella Natté, Solids, Savane & Heritage	<b>€ 215</b> WAL446	<b>€ 150</b> WAL447
	<b>COLOR ON REQUEST 2</b> Only for Sunbrella Chartres	<b>€ 235</b> WAL430	<b>€ 175</b> WAL428
	<b>COLOR ON REQUEST 3</b> Only for Sunbrella Lopi & Domino	<b>€ 260</b> WAL431	<b>€ 200</b> WAL429

## LUMBAR- AND DECO CUSHIONS

Outer dimensions (l x w x t)

Please store the cushions inside when not in use

\* Leaving the collection. Available while supplies last

















		 <b>LUMBAR CUSHION</b> <i>30 x 50 x 17 cm</i>	 <b>DECO CUSHION</b> <i>50 x 50 x 17 cm</i>
	<b>GREY CHINÉ</b> Sunbrella® Natté	<b>€ 80</b> WAL440	<b>€ 105</b> WAL123
	<b>DARK TAUPE</b> Sunbrella® Natté	<b>€ 80</b> WAL410	<b>€ 105</b> WAL122
	<b>COCONUT</b> Sunbrella® Savane	<b>€ 80</b> WAL407	<b>€ 105</b> WAL394
	<b>MARBLE</b> Sunbrella® Lopi	<b>€ 100</b> WAL408	<b>€ 125</b> WAL395
	<b>CHARCOAL</b> Sunbrella® Lopi	<b>€ 100</b> WAL409	<b>€ 125</b> WAL396
	<b>SOOTY *</b> Sunbrella® Chartres	/	<b>€ 115</b> WAL132
	<b>LEAF GREEN</b> Sunbrella® Heritage	<b>€ 80</b> WAL413	<b>€ 105</b> WAL130
	<b>MOSS</b> Sunbrella® Heritage	<b>€ 80</b> WAL415	<b>€ 105</b> WAL400

## LUMBAR- AND DECO CUSHIONS

Outer dimensions (l x w x t)

Please store the cushions inside when not in use





\* Leaving the collection. Available while supplies last

		 <b>LUMBAR CUSHION</b> <i>30 x 50 x 17 cm</i>	 <b>DECO CUSHION</b> <i>50 x 50 x 17 cm</i>
	<b>ALPINE</b> Sunbrella® Heritage	<b>€ 80</b> WAL562	<b>€ 105</b> WAL569
	<b>LOTO *</b> Sunbrella® Domino	/	<b>€ 125</b>  WAL419
	<b>RUST</b> Sunbrella® Heritage	<b>€ 80</b>  WAL414	<b>€ 105</b>  WAL399
	<b>CRAPS *</b> Sunbrella® Domino	<b>€ 100</b> WAL404	/
	<b>BLUSH</b> Sunbrella® Solids	<b>€ 80</b>  WAL417	<b>€ 105</b> WAL128
	<b>BISCUIT *</b> Sunbrella® Lopi	<b>€ 100</b>  WAL564	/
	<b>COLOR ON REQUEST 1</b> Only for Sunbrella Natté, Solids, Savane & Heritage	<b>€ 105</b> WAL423	<b>€ 130</b> WAL133
	<b>COLOR ON REQUEST 2</b> Only for Sunbrella Chartres	<b>€ 115</b> WAL424	<b>€ 140</b> WAL426
	<b>COLOR ON REQUEST 3</b> Only for Sunbrella Lopi & Domino	<b>€ 125</b> WAL425	<b>€ 150</b> WAL427

## FOOTSTOOL

Outer dimensions (l x w x h) | Standard seating height: 32,5 cm







Morbern Sundance upholstery + galvanized steel frame & feet (standard galvanized feet are included)

		 <b>CHALK</b>	 <b>SAFARI</b>	 <b>EARTH</b>
	110 x 80 x 32,5 cm	€ 740 WAL324	€ 740  WAL325	€ 740 WAL512

## TABLES

Outer dimensions (l x w x h)



Galvanized steel frame (& legs) | Hellwood = 100% PEFC

		  <b>HELLWOOD</b> <i>Thermally treated wood tabletop</i>	 <b>IROKO</b> <i>Tropical hardwood tabletop</i>
	<b>COFFEE TABLE</b> 110 x 82 x 13,5 cm	€ 1090 WAL065	€ 1160 WAL064
	<b>CORNER SQUARE TABLE</b> 110 x 110 x 13,5 cm	€ 1375 WAL067	€ 1470 WAL066
	<b>LINKING TABLE</b> 110 x 75 x 13,5 cm	€ 830 WAL069	€ 860 WAL068

## FEET

Galvanized steel or Structured powder coated steel

1 set of 4 feet per module

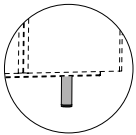
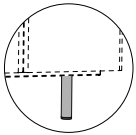
		 <b>GALVANIZED STEEL</b>	 <b>ANTHRACITE</b> <i>RAL7016</i>
	<b>FEET</b> Seating height: 32,5 cm	€ incl.	€ 15/set WAL071
	<b>HIGH FEET</b> Seating height: 37,5 cm	€ 60/set WAL072	€ 75/set WAL073



**POPULAR FABRIC COMBINATIONS**

Numerous color combinations are possible  
 To make life easier, we have created several color combinations,  
 carefully composed following Extremis' color concepts.

Need any help finding the right color combination?  
 Go check our Biomes on page 169

**Out of the Fjordinary**  
*A boreal and montane togetherness biome*



Walrus base color — **Chalk**



Blanket  
**Charcoal**



Comfort cush.  
**Grey chiné**

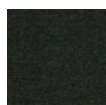

Lumbar cush.  
**Alpine**

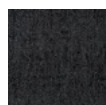

Deco cush.  
**Sooty**

**Forest & Fields**  
*A green and rural togetherness biome*



Walrus base color — **Earth**



Blanket  
**Coconut**



Comfort cush.  
**Marble**

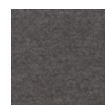

Lumbar cush.  
**Dark taupe**

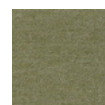

Deco cush.  
**Leaf green**

**A Lotta Terracotta** 🌿  
*A mediterranean togetherness biome*



Walrus base color — **Safari**



Blanket  
**Coconut**

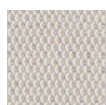

Comfort cush.  
**Marble**



Lumbar cush.  
**Blush**

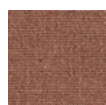

Deco cush.  
**Rust**

**Majestic Mirage** 🌿  
*A sandy and breezy togetherness biome*



Walrus base color — **Safari**

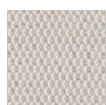

Blanket  
**Marble**

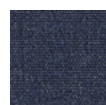

Comfort cush.  
**Indigo**

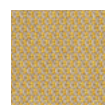

Lumbar cush.  
**Biscuit**



Deco cush.  
**Loto**

## WALRUS COMBINATIONS

Some predefined combinations, connection piece(s) are included in the price samples below

Blankets & cushions are included in the price samples below

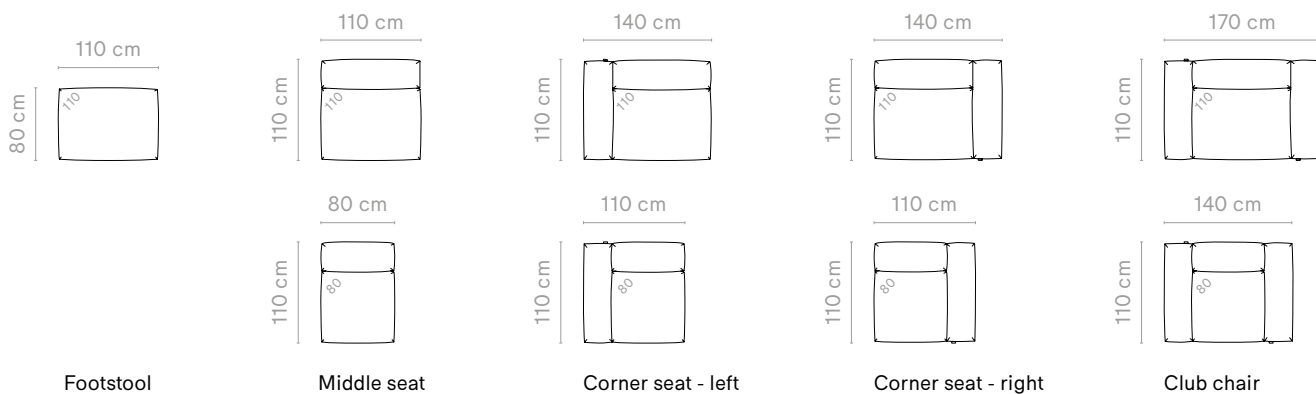

## WALRUS DOUBLE TROUBLE

Walrus base - Chalk + Out of the Fjordinary cushion set

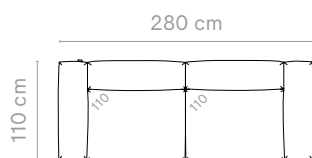

WAL314 (x2) + WAL158 + WAL358 (x2) + WAL442 (x2) +  
WAL132 (x2) + WAL562 (x2)

€ 8460

## WALRUS LOVELY LOUNGER

Walrus base - Earth + Forest & Fields cushion set

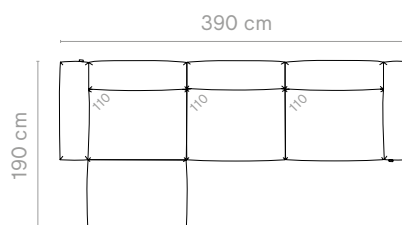

WAL509 (x2) + WAL508 + WAL512 + WAL158 (x2) +  
WAL356 (x3) + WAL371 (x3) + WAL130 (x3) + WAL410 (x3)

€ 12190

## WALRUS COMBINATIONS

Some predefined combinations, connection piece(s) are included in the price samples below

Blankets & cushions are included in the price samples below

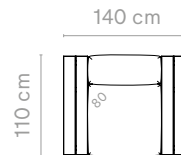
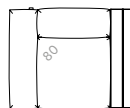
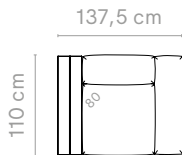
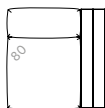
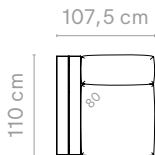
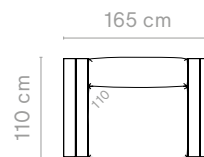
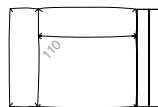
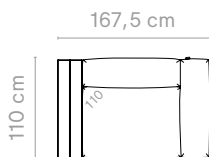
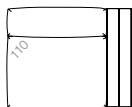
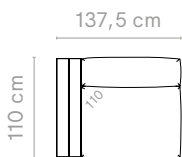

Seat with side table

Seat with armrest & side table

Seat with 2 side tables

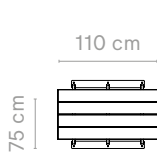
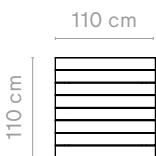

Coffee table

Corner table

Linking table

## WALRUS MEET THE PARENTS

Walrus base - Safari + Majestic Mirage cushion set

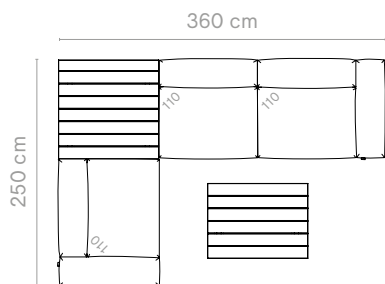

## WALRUS MAJESTIC MONDO

Walrus base - Safari + A Lotta Terracotta cushion set

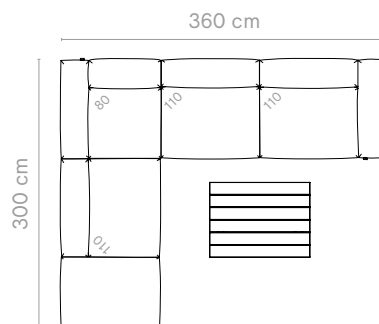

WAL315 (x2) + WAL317 + WAL158 + WAL357 (x3) +  
WAL379 (x3) + WAL419 (x3) + WAL564 (x3) + WAL064 +  
WAL066

€ 14375

WAL315 + WAL317 (x2) + WAL316 + WAL325 + WAL158 (x3) +  
WAL356 (x3) + WAL363 + WAL371 (x3) + WAL384 +  
WAL399 (x4) + WAL417 (x4) + WAL064

€ 15860

# Finishes

---

Generally speaking, aluminum and steel are low-maintenance materials. Thanks to powder coating techniques, these materials are available in several colors. Choose white only if you are willing to take greater care and clean your products regularly. If you are not big on cleaning you should consider galvanized steel for your furniture.

Colors may vary from batch to batch.

Galvanized steel



Black — RAL9005



Earth — RGB 88 88 84

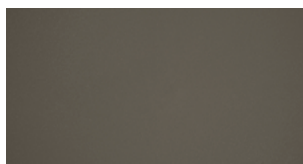

Beach beige — RAL1019

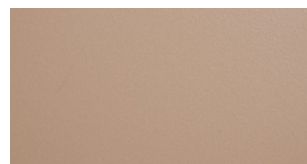

Off white — RAL9002

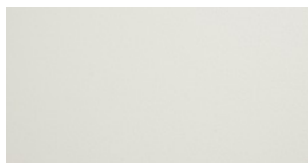

Verdigris — RGB 133 147 142

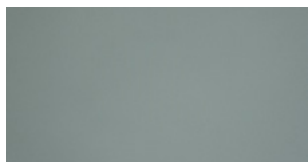

Reed green — RAL6013

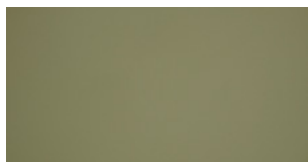

Copper brown — RAL8004

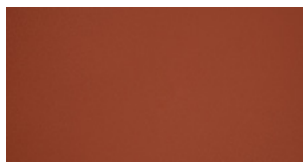

Cosmic cream — RAL1015

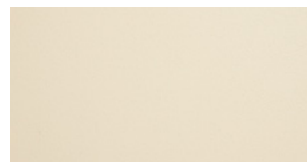

Cobalt blue — RAL5013



Sun yellow — RAL1032



Pistache — RAL6021

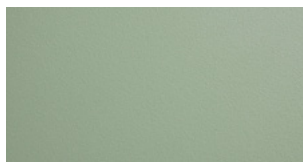

# Sunbrella®

---

Sunbrella® is an acrylic fabric that is still known as the best outdoor fabric available for making cushions. The raw material is Sunbrella® solution-dyed acrylic fibre. The color pigments are locked right into the very heart of the fibres during the initial stage of the manufacturing process, before the yarn is even made. Sunbrella® colors stand up to tough weather conditions and years of sun exposure.

Colors may vary from batch to batch.

Grey chiné — Natté



Dark taupe — Natté

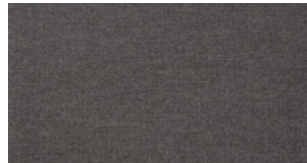

Coconut — Savane



Marble — Lopi



Charcoal — Lopi



Sooty — Chartres

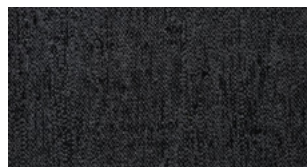

Leaf green — Heritage



Moss — Heritage



Alpine — Heritage

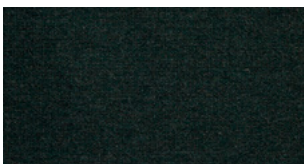

Indigo — Heritage

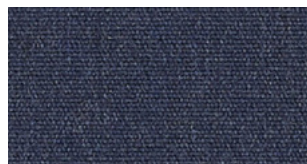

Loto — Domino



Rust — Heritage

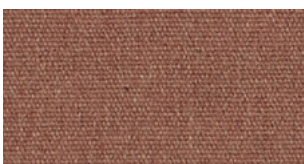

Craps — Domino



Blush — Solids

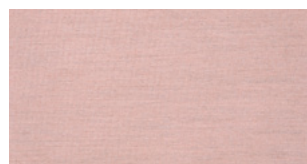



















































































Biscuit — Lopi











































































# Finishes

Easily navigate through this color matrix for finishes to discover which colors are available for each product.

	Acacia 	AMAI 	Anker 	Bistroo 	Captain's Chair shell 	Captain's Pipe legs 	Captain's sliding legs 	Captain's High Sliding legs 	Captain's Lounge legs 	Hopper bench 	Hopper combo 	Hopper picnic 
Galvanized STEEL												
Black RAL9005												
Earth RGB 88 88 84												
Beach beige RAL1019												
Off white RAL9002												
Papyrus white RAL9018												
Verdigris RGB 133 147 142												
Reed green RAL6013												
Copper brown RAL8004												
Cosmic cream RAL1015												
Cobalt blue RAL5013												
Sun yellow RAL1032												
Pistache RAL6021												

\* Leaving the collection. Available while supplies last.

Inumbra	Kosmos	Manille	Marina	Panigiri	Pantagrueel	Picnik	Sensu	Sol+Luna	Tiki stools	Tiki table	Virus
											
											
											
											
											
											
											
											
											
											
											
											
											

# Sunbrella®

Explore our Sunbrella color matrix for a quick and easy way to identify the available colors for each product.

	AMAI HiLo bench	Bistro	Captain's Chair	Deco cushions	Gargantua	Hopper	Kosmos	Marina	Panigiri	Pantagruel	Sol+Luna	Tiki	Virus	Walrus
Grey chiné NATTÉ														
Dark taupe NATTÉ														
Coconut SAVANE														
Marble LOPI														
Charcoal LOPI														
Sooty * CHARTRES														
Leaf green HERITAGE														
Moss HERITAGE														
Indigo * HERITAGE														
Alpine HERITAGE														
Loto * DOMINO														
Rust HERITAGE														
Craps * DOMINO														
Blush SOLIDS														
Biscuit * LOPI														

\* Leaving the collection. Available while supplies last.



# Biomes

Biomes are the large vegetation zones of the earth. Each biome undeniably evokes a certain atmosphere. We drew on them to design color palettes in order to make it easier to combine our products and cushions.

## Out of the Fjordinary

*A boreal and montane togetherness biome*

*We translated the northern biomes into a balanced color palette, transcending the ordinary through a blend of nature's most incredible beauty*

Powder coating colors

Sunbrella fabric colors

<ol style="list-style-type: none"> <li>1. Black</li> <li>2. Off white</li> <li>3. Cobalt blue</li> <li>4. Pistache</li> <li>5. Verdigris</li> </ol>	<ol style="list-style-type: none"> <li>1. Grey chiné</li> <li>2. Moss</li> <li>3. Alpine</li> <li>4. Indigo</li> <li>5. Sooty</li> <li>6. Charcoal</li> </ol>
---	---

## Forest & Fields

*A green and rural togetherness biome*

*Rooted in West-Flemish tradition, we blend temperate forest elements - the main European biome - with local clay and hay for a unique touch*

Powder coating colors

Sunbrella fabric colors

<ol style="list-style-type: none"> <li>1. Black</li> <li>2. Verdigris</li> <li>3. Reed green</li> <li>4. Earth</li> <li>5. Off white</li> </ol>	<ol style="list-style-type: none"> <li>1. Marble</li> <li>2. Coconut</li> <li>3. Biscuit</li> <li>4. Moss</li> <li>5. Leaf green</li> <li>6. Sooty</li> <li>7. Dark taupe</li> </ol>
---	--

## A Lotta Terracotta

*A mediterranean togetherness biome*

*Welcome to warm earthy tones and terracotta red shores: this is just the perfect holiday color palette*

Powder coating colors

Sunbrella fabric colors

<ol style="list-style-type: none"> <li>1. Beach beige</li> <li>2. Cosmic cream</li> <li>3. Copper brown</li> <li>4. Earth</li> <li>5. Off white</li> </ol>	<ol style="list-style-type: none"> <li>1. Marble</li> <li>2. Biscuit</li> <li>3. Coconut</li> <li>4. Blush</li> <li>5. Rust</li> <li>6. Indigo</li> <li>7. Dark taupe</li> </ol>
--	--

## Majestic Mirage

*A sandy and breezy togetherness biome*

*Embark on a captivating nighttime escapade where gentle hues of yellows and rich accents cast a mesmerizing allure over the dunes*

Powder coating colors

Sunbrella fabric colors

<ol style="list-style-type: none"> <li>1. Off white</li> <li>2. Sun yellow</li> <li>3. Cosmic cream</li> <li>4. Cobalt blue</li> <li>5. Beach beige</li> </ol>	<ol style="list-style-type: none"> <li>1. Marble</li> <li>2. Coconut</li> <li>3. Craps</li> <li>4. Biscuit</li> <li>5. Indigo</li> <li>6. Loto</li> </ol>
--	---

# Professionals

---

Professionals, we've got you covered! Whether you're an architect, designer, or a pro in the world of landscape, office, education, or hospitality, we've got the tools you need to make your projects shine with Extremis.

[www.extremis.com/pro](http://www.extremis.com/pro)

## CUSTOM COLORS

We believe that color has the power to elevate the esthetic appeal of any project, allowing for harmonious integration within various environments. Whether it's a vibrant hue that captures attention or a subtle tone that complements the surrounding elements. That's why most of our products are available in any RAL-color you want.

Startup fee of € 300 (ex. VAT) per color.



## FLOOR FASTENING

Through innovative engineering and meticulous attention to detail, we ensure that our furniture remains securely anchored to the ground. This offers peace of mind to both designers and end users, knowing that our anchoring systems not only deter theft but also prevent the furniture from being dislodged or blown away by strong winds.

However, it's important to note that the installation of our products should be done by qualified individuals. The anchoring process involves using suitable bolts or screws, which can be obtained from a specialized store. The selection of these components greatly depends on the material your terrace is made of. This ensures that the anchoring is not just secure, but also perfectly suited to your specific environment.

## DOWNLOADS

Get the complete packages of all technical and inspirational materials from a single destination: [www.extremis.com/en/product-downloads](http://www.extremis.com/en/product-downloads)

- Product pictures
- 2D & 3D files (2d dwg, 3d dwg, sketchup, revit, 3d max, 3ds max)
- Product factsheets
- Spec sheets
- Manuals



## CONFIGURATOR

Showrooms, pictures, samples, we have it all. But what is the dream terrace your client is looking for? You don't need a magic wand to get inside their heads. With our configurator, you customize their favorite pieces in a snap. Size, colors, materials - a computer or a phone will do!

Found the perfect match? Show your clients what it might look like in their own space! The augmented reality feature makes our pieces more tangible than ever!

[www.extremis.com/configurator](http://www.extremis.com/configurator)

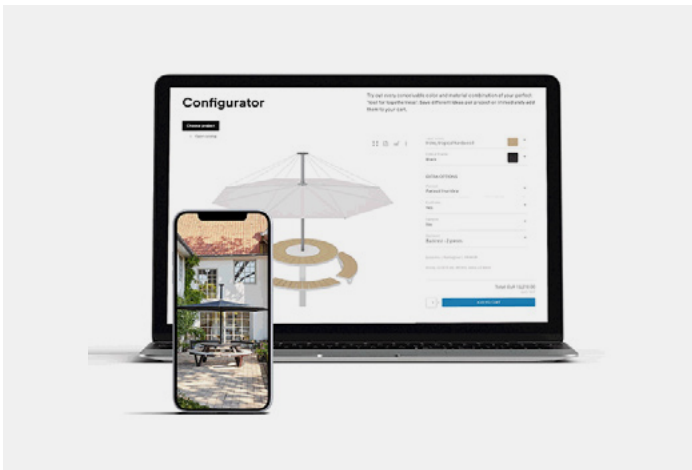

## REFERENCES

We are proud to work with clients around the world across a wide range of sectors. No matter the scope of your project, our collection offers a solution for every space. Just access the references gallery and filter on setting or product type to get inspired. Create mood boards for your projects by saving everything you need from our website.

[www.extremis.com/references](http://www.extremis.com/references)

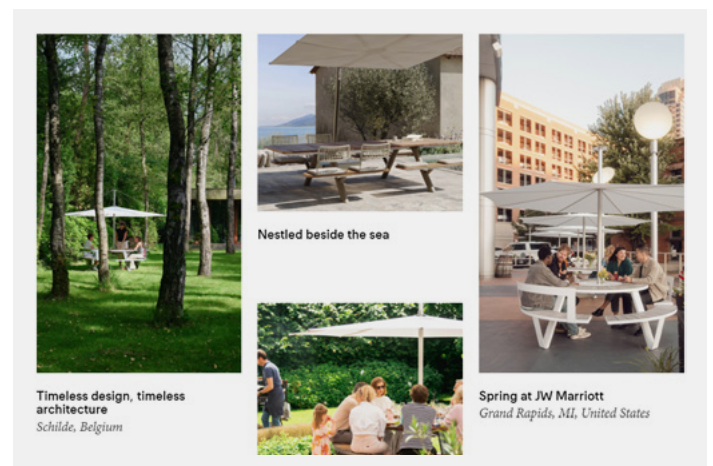

# Wheelchair accessibility



Our innovative tables and picnic benches have been built with wheelchair users in mind. This not only allows the users to gain access to the tables but also contributes to the social aspects of sitting at the same table. Besides facilitating wheelchair access, this furniture is also perfect for pushchairs. They are 'Tools for Togetherness' for everyone and support full inclusivity.

As specifications for wheelchair accessibility vary around the world, please visit our technical sheets to ensure the measurements of each solution meets the specifications of your local requirements.

The following products don't need any product modifications.

## AMAI

Double side access

Tabletop at standard position



Accessible on both sides



Not possible when tabletop is put in the highest position



Accessible on both sides



Not possible on both ends

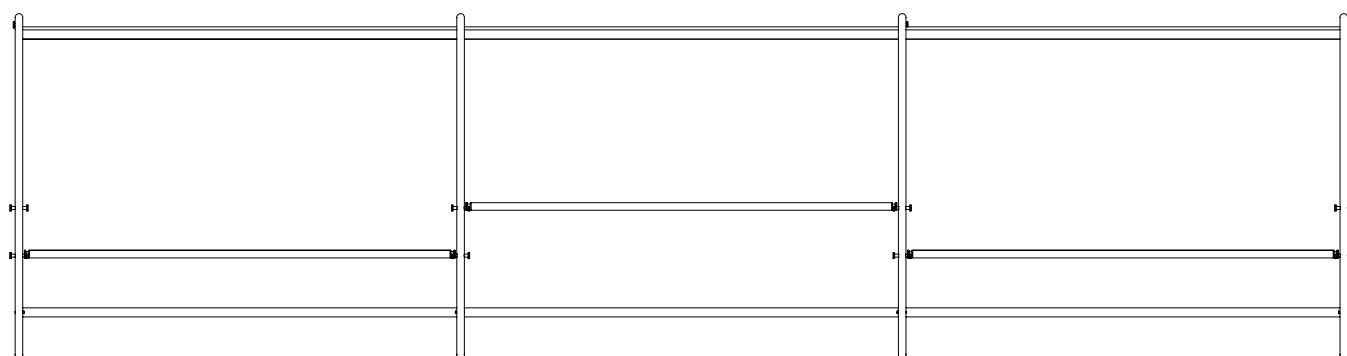

68,5 cm

**HOPPER BENCH**  
Single side access

Only accessible on side with no bench

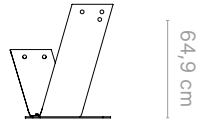

**HOPPER BENCH AA**  
Single side access

Only accessible on side with no bench

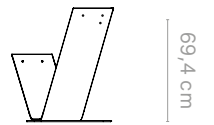

**HOPPER COMBO**  
Single side access

Only accessible on side with no bench

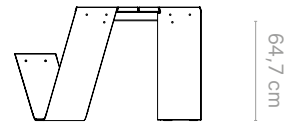

**HOPPER COMBO AA**  
Single side access

Only accessible on side with no bench

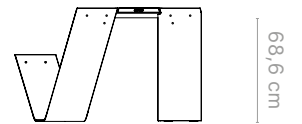

### MARINA COMBO

Double side & Single end access



Accessible on this end



Accessible on sides with no benches



Not possible on this end

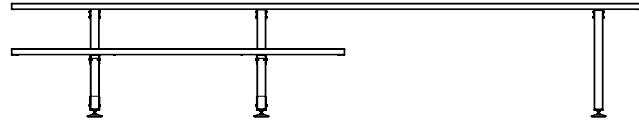

71 cm

### MARINA PICNIC

Double end access

Not possible for the 165 cm version



Accessible on both ends

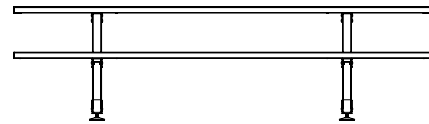

71 cm

### MARINA DOUBLE DESK

Double side access



Not possible on both ends



Accessible on both sides

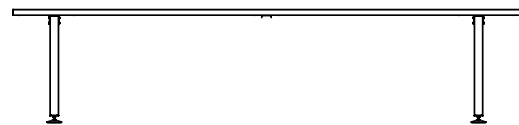

71 cm

### MARINA TABLE

Double side access



Not possible on both ends



Accessible on both sides

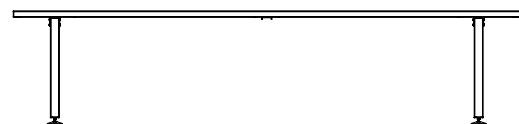

71 cm

**MANILLE**

Double end access

Accessible  
on both ends

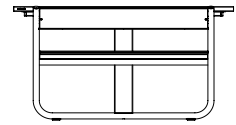

68,2 cm

**PANIGIRI**

Double side & Double end access

Accessible  
on both ends



Accessible on sides  
with no benches

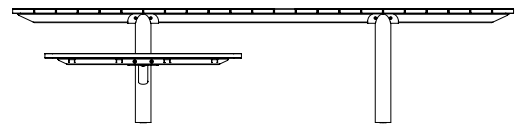

65,2 cm

**PICNIK**

Single end access

Accessible on the open  
side of the tabletop

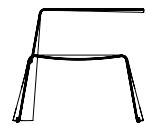

72,1 cm

**GARGANTUA**

Single end access

Two benches at  
tabletop height

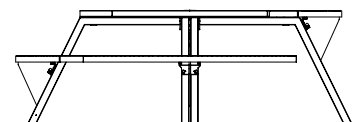

70,8 cm

# Virus wheelchair accessibility

Our furniture is made to last, so picking the right piece is a crucial step in completing your project plans. We strive to make our furniture both accessible and inclusive. So with some minor adaptations we made the Virus picnic tables accessible for those with mobility issues. By removing one of the legs, in the Virus 4 or 5-seater, a wheelchair fits perfectly in the gap.

## VIRUS 4-SEATER WHEELCHAIR

One leg has to be removed  
Only possible when combined with floor fastening

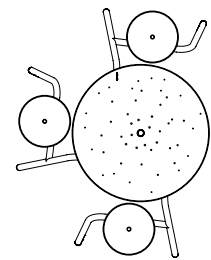

Virus 4-seater Standard tabletop (incl. floor fastening)	<b>€ 1890</b>
--	---------------

Virus 4-seater Solid tabletop (incl. floor fastening)	<b>€ 1870</b>
---	---------------

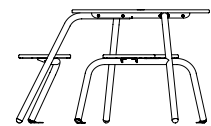

68,9 cm

## VIRUS 5-SEATER WHEELCHAIR

One leg has to be removed

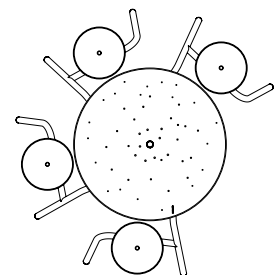

Virus 5-seater Standard tabletop	<b>€ 2180</b>
-------------------------------------	---------------

Virus 5-seater Solid tabletop	<b>€ 2150</b>
----------------------------------	---------------

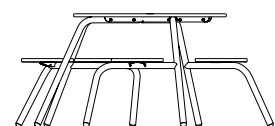

68,9 cm

Virus 5-seater Standard tabletop (incl. floor fastening)	<b>€ 2305</b>
--	---------------

Virus 5-seater Solid tabletop (incl. floor fastening)	<b>€ 2280</b>
---	---------------



# Hopper picnic wheelchair accessibility

Our baseline 'Tools for Togetherness' implies that we provide high quality products for everybody, even our wheelchair using friends. Proof are the tailor-made versions of our popular Hopper picnic tables. By shortening the benches on one or two sides, wheelchair access is facilitated. Let's bring inclusivity to the table!

The price of the Hopper picnic is subject to size, finish and quantity. Keep in mind that these special Hopper picnic versions are only available in 300 cm and 360 cm.

## HOPPER PICNIC WHEELCHAIR

One bench has been made shorter to gain room for a wheelchair  
A stainless steel connection piece connects the two legs

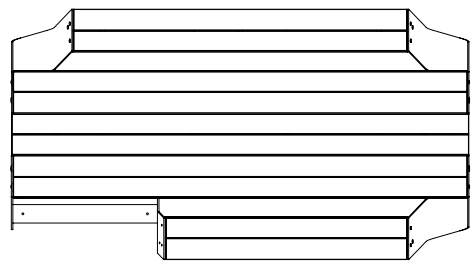

94 cm

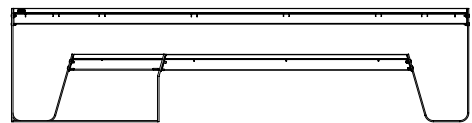

64,7 cm

## HOPPER PICNIC WHEELCHAIR AA

One bench has been made shorter to gain room for a wheelchair  
A stainless steel connection piece connects the two legs

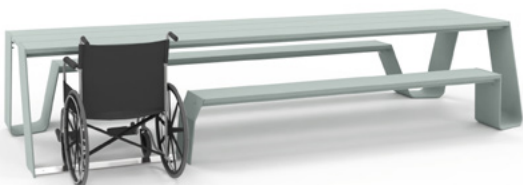
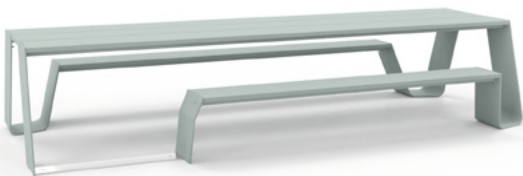

94 cm

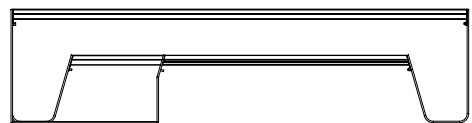

68,6 cm

# Charging modules

By connecting quality, necessity and functionality, Extremis generates togetherness all over the world. We're still searching for ways to empower people and to spark interactions that truly matter. How? By energizing our current furniture collection, each patio, office space and lunch area is ready to be powered up.

Extend outdoor possibilities, break down boundaries, and stay connected with this shocking furniture. With this power option, the outdoor table becomes an all-purpose set. Your battery died? No problem!



## WIRELESS CHARGER - OUTDOOR & INDOOR

Outer dimensions (ø): 8 cm

Wireless charger on top, compatible with all devices with wireless charging system

It has a quick charge system | One battery included



2 x USB on battery pack  
Battery 55 wh - Antenna 5w  
IP65 & Shockproof

**€ 410**  
ELE001

## CHARGING TRAY FOR WIRELESS POWER

Outer dimensions (l x w x h): 24 x 8 x 9 cm

Charges up to four stations simultaneously in 7 hours | 4 charging slots

Includes magnetic key to remove the station from its support

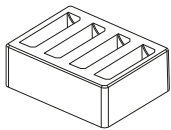

For Europe

**€ 290**  
ELE002

**ANKER**



**BISTROO**



**GARGANTUA**

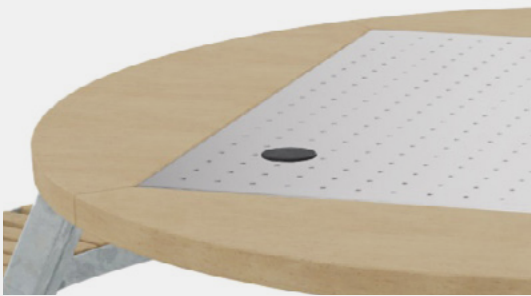

**HOPPER**



**MARINA**



**PANTAGRUEL**



**VIRUS**



# Maintenance tools

The extreme quality of the materials used in Extremis products and the way they are designed only serve one good cause: To. Last. Longer. Nothing goes without a little effort however. Maintenance is needed to stand the test of time. So please have a look at our maintenance products and our tips to keep your tool for togetherness in excellent shape.

[www.extremis.com/maintenance](http://www.extremis.com/maintenance)

Order your maintenance tools on our Dealer Portal

[www.extremis.com/portal](http://www.extremis.com/portal)



## WOOD CLEANER - 1L

Wood Cleaner is a cleansing shampoo for wooden furniture. The product removes gray discoloration, green deposits and dirt

OND001



## MULTI CLEANER - 0,5L

Extremis Multi Cleaner is a ready to use cleaner. Its powerful formula removes the most persistent stains

OND004



## WOOD PROTECTOR - 1L

Protect your wood regularly from UV and inclement weather. The Extremis wood protector is a 100% natural product

OND002



## EXTREMIS BRUSH

Use this hand scrubber in combination with Extremis Wood Cleaner and Multi Cleaner to remove persistent dirt

OND006



### **WOOD CLEANING KIT**

Wood Cleaner - Wood protector 1L - Extremis brush - Tape - Sanding block - Brush

OND057



### **GENERAL CLEANING KIT**

Multi Cleaner - Sponge - Microfiber cloth - Extremis brush

OND058

# Wood

---

**Wooden structures in the sea such as pontoons, piers, jetties and so on are living proof of the soundness of wood as a suitable material for the structure and finish of outdoor applications. Almost constantly in contact with salt water and subject to biting winds and high UV densities, the wood may well turn grey, but it lasts for decades, which makes it a superb material.**

Choose wisely

---

Wood is a living material and in spite of the superior quality provided by the species we use, it constantly has to adapt to extreme changes in temperature and humidity. Due to internal stress resulting from these constant adaptations the wood "warps". This warping can lead to cracking, among other things. Changes in color and structure can also appear. These characteristics are typical of the material and by choosing this material you accept them. When delivered, the wooden parts of our products are untreated. Exposure to sun and rain will gradually change their color to silvery gray, and also roughen the surface. We strongly recommend that you treat your wood regularly with wood oil to protect it from stains and to slow down the roughening process. In some cases, white spots might appear in the wood, especially in Iroko hardwood. These tiny dots are calcium carbonate deposits that become a part of the wood when the tree absorbs water from an alkaline soil. The calcium fragments don't change the quality of the wood, but they are visible to the eye. From a durability standpoint, Extremis will not throw out this quality wood, however, when there are more than ten spots visible per 100 cm<sup>2</sup>, the wood is no longer used in our regular sale, but gets a second life for demonstration and R&D purposes.

## Iroko

Used for Anker - Gargantua - Hopper - Pantagruel - Walrus

---

Iroko is an African species of tropical hardwood. The high quality allows us to make wide tabletop segments out of one piece of wood. The color and characteristics of the wood are similar to teak. Our suppliers have their own concession and guarantee to deliver only the best quality Iroko hardwood, with a clear paper trail to guarantee sustainable entrepreneurship.

Choose wisely

---

Like all wood, Iroko will gradually become rough and grayish by exposure to the sun and rain, small cracks and crevices may also appear as part of this process. We strongly advise to yearly treat the furniture with our Wood Protector. The natural oil protects the wood from moisture and spilled liquids, which keeps the wood stable for longer and keeps stains superficial.

# Hellwood 100% PEFC

Used for AMAi - Anker - Hopper - Manille - Panigiri - Pantagruel - Walrus



Extremis Hellwood is European thermally treated wood that has been through purgatory to steel it against all kinds of hellish ordeals. And there are more than enough of them out there: UV rays, rain and acid rain, fluctuating humidity levels, frost, extreme heat and so on. Our preservation gives the fibers greater internal stability and increases their resistance to rotting. In this way, we obtain a type of wood that belongs in Durability Class I, just like the very best tropical wood. An attractive side-effect of the process, of course, is the wood's dark coloring.

Choose wisely

Like all wood, Hellwood will gradually become rough and grayish by exposure to the sun and rain, small cracks and crevices may also appear as part of this process. We strongly advise to yearly treat the furniture with our Wood Protector. The natural oil protects the wood from moisture and spilled liquids, which keeps the wood stable for longer and keeps stains superficial.

# Rubberwood

Used for Sticks

---

The wood of the rubber tree (rubberwood) is very valuable: it has a very nice light color, high stability as a result of the low level of shrinkage and it is very easy to process. Perfect for indoors! Rubberwood is very popular for making stairs and furniture... or basically anything made of wood. Choose the natural version, or the dark washed version using oil. At Extremis we first use the latex from the rubberwood tree to make the rubber Sticks bases and once the trees are too old to tap latex, instead of chopping and burning the wood, we use the wood to make the rubberwood Sticks bases.

Choose wisely

---

As rubberwood is only used inside, it needs no maintenance. The dark washed version has a dark gray look with the wood grain still visible. This is far from a black base.

# Oak

Used for Tiki

---

Oak wood is a type of hardwood commonly used for furniture making, flooring, barrel making or timber frame buildings. It is mainly appreciated for its robustness and durability. Many also appreciate its prominent grain and light attractive color. Oak is a popular choice for interiors, as it brings a warm, natural feeling to any room.

Choose wisely

---

As most woods, oak wood should be oiled frequently if you want to maintain its look longer. However, since it's a natural material that is easy to repair and refinish and since it is used inside, its maintenance will be lighter than for outdoor use.

# Bamboo

Used for Bistrot

---

Our durable bamboo components are made from solid Bamboo strips originating from China. Thanks to a unique engineering process of compression under high temperature and pressure, an exceptional hardness and durability is achieved. Our suppliers only uses certified environment friendly ingredients for this specific technique. Made with high attention to detail and precision, providing us with a high quality and sustainable product.

Choose wisely

---

Each Bamboo service has been treated with a wood oil to protect it from stains and internal changing climate conditions. The Bamboo wood is easy to clean with water and mild household soap. Don't use aggressive cleaning products or sand the surface.



# Aluminium

---

**Aluminium is one of the most common substances on earth. It is a metal offering an exceptional combination of properties. It is light and 100% recyclable. The alloys we use contain maximum 30% virgin material.**

## Fine structured powder coating

Used for AMAi - Anker - Bistrot - Hopper - Kosmos - Picnik - Sensu - Sol+Luna - Tiki stools - Virus

---

Powder coating is a technique of applying dry paint to a part. The powdered paint is electrostatically charged and sprayed onto the object. The object is then placed in an oven and the powder particles melt and coalesce to form a continuous film. The fine textured powder-coating has a high scratch resistance, perfect for intensive use.

Choose wisely

---

Choose white powder coating, only if you are willing to clean the surface regularly. There is nothing uglier than a dirty piece of design furniture, right?

## Anodized

Used for Sol+Luna shade

---

Anodizing is a process which increases the thickness of the natural oxide layer on the surface of the aluminium. This layer protects the aluminium from corrosion. We have chosen not to give the aluminium any further treatment, as this would not lengthen its lifespan and would also be very bad for the environment.

Choose wisely

---

Easy to clean with lukewarm water and a mild detergent.

# Steel

---

**Steel is an alloy of iron and other elements, primarily carbon, that is widely used in construction and other applications because of its high tensile strength. Steel's base metal is iron, the element that rusts when in direct contact with oxygen. There are three ways to cope with this property: block direct contact with the air (e.g. by galvanizing), replace a certain amount of iron with carbon (e.g. stainless steel), or use rust as a finish (e.g. weathering steel).**

Choose wisely

---

Steel may rust sooner or later, so try to keep surfaces clean and dry, and in any case do not leave metal objects outside on top of any other steel surface. A chemical reaction occurs that will affect the other surface. As soon as rust has been noticed, act immediately and accordingly, as rust accelerates rusting.

# Galvanized

---

Used for Acacia - AMAi - Anker - Captain's Chair - Gargantua - Hopper - Inumbrina - Kosmos - Manille - Panigiri - Pantagruel - Senu - Tiki Trolley - Walrus

Galvanization is the most durable method for protecting metal from rusting. The metal is immersed in a zinc bath which results in a protective layer. If the layer gets damaged, the metal underneath will start rusting. However any damage can be touched up with zinc paint available from any DIY store. Galvanized steel has a very long life span and is perfectly recyclable if necessary.

Choose wisely

---

We call it the George Clooney of coating techniques: its looks improve better with age... Our tools with galvanized surfaces are masters of camouflaging dirt, thanks to the materials rough texture. At first, galvanized pieces look very shiny, but they will gradually turn matt under the influence of sun and rain. Rain may also cause dark stains underneath the connection zones.

# Fine structured powder coating

---

Used for Anker - Bistrot - Captain's Chair - Marina - Pantagruel - Tiki stools - Tiki table - Virus

Powder coating is a technique of applying dry paint to a part. The powdered paint is electrostatically charged and sprayed onto the object. The object is then placed in an oven and the powder particles melt and coalesce to form a continuous film.

Choose wisely

---

Choose white powder coating, only when you are willing to clean the surface regularly. There is nothing uglier than a dirty piece of design furniture, right? Our glossy powder-coating is very maintenance-friendly, however.

# Stainless 316

Used for AMAi shade - Gargantua - Hopper shade - Inumbra - Kosmos shade - Manille shade

---

The highest stainless steel quality available is type AISI 316. Aggressive environmental conditions caused by chlorides, acid rain, salt and other rusty materials will require periodic maintenance.

Choose wisely

---

We advise a regular treatment with stainless steel cleaner or protector, especially in aggressive environments. Products to clean and protect are widely available.

# Stainless 304

Used for Inumbra - Inumbrina - Kosmos shade

---

For some products we combine different high quality types of stainless steel. Aggressive environmental conditions caused by chlorides, acid rain, salt and other rusty materials will require periodic maintenance.

Choose wisely

---

We advise regular treatment with stainless steel cleaner or protector, especially in aggressive environments. Products to clean and protect are widely available.

# Fine structured powder coated ZnAlMg

Used for AMAi - Anker - Tiki table - Virus

---

ZnAlMg-dipping is an alternative to hot dip galvanization and is the best choice for more detailed products that need to be coated afterwards. Thanks to its unique composition, ZnAlMg provides high level of surface and cut-edge protection, even in the most hostile environments. It is produced on a classic hot dip galvanising line which molten bath has a unique chemical composition including zinc, aluminium, and magnesium, the perfect base layer for powder coatings.

Choose wisely

---

Choose white powder coating, only if you are willing to clean the surface regularly. There is nothing uglier than a dirty piece of design furniture, right?

# Fine structured powder coated stainless steel

Used for Acacia - AMAi - Bistrot - Captain's Chair - Inumbra - Manille - Panigiri - Pantagruel - Sol+Luna - Tiki stools - Tiki table - Virus

---

Powder coating is a technique of applying dry paint to a part. The powdered paint is electrostatically charged and sprayed onto the object. The object is then placed in an oven and the powder particles melt and coalesce to form a continuous film.

Choose wisely

---

Choose white powder coating, only if you are willing to clean the surface regularly. There is nothing uglier than a dirty piece of design furniture, right?

# Composites & plastics

---

**A composite is made of at least two constituent materials with different material properties, resulting in a new material with better characteristics. We add plastics to this category, as no plastic is ever applied without adding fibres or fillers.**

## Fiberglass

Used for Sticks

---

Fiberglass reinforced polyester resin material is made with what is called the pull-trusion technique. Pull-trusion is a non-stop process of fiberglass wires pulled through a bath of polyester resin that harden in a matrix afterwards to get their final shape. The main advantages of this material are its strength, corrosion-durability and light weight.

Choose wisely

---

Choose white fiberglass tabletops and benches only if you are willing to clean the surface regularly. Don't use aggressive detergents or abrasives as you will scratch the invisible UV layer. Fiberglass sawdust may stick to the surface use gloves for installation, or clean beforehand. Tree leaves, dust, CO2 emissions etc. may leave marks on a spotless white surface, so keep this in mind when choosing the perfect location for your product.

## Coated fiberglass

Used for Marina

---

Coated fiberglass is a technique of applying wet paint to a fiberglass profiles. The paint is sprayed onto the profiles. The object is then placed in an oven to form a continuous film.

Choose wisely

---

Choose light colors, only if you are willing to clean the surface regularly. There is nothing uglier than a dirty piece of design furniture, right?

## HPL

Used for Kosmos - Pantagruel - Sol+Luna

---

High pressure laminate (HPL) is a flat panel based on thermosetting resins, homogeneously reinforced with wood fibres and manufactured under high pressure and at high temperatures. Its integrated surface is based on pigmented resins cured by electron beams. The modulus of elasticity and high tensile and flexural strength guarantee HPL's high impact resistance. The closed surface makes it easy to clean.

Choose wisely

---

Choose a white HPL tabletop only if you are willing to clean the surface regularly.

# Polypropylene

Used for Captain's Chair

---

Polypropylene is resistant to stress corrosion. It may sound crazy that corrosion can also occur in plastics but it is true. This results in cracking, especially in areas where mechanical stress occurs in combination with a chemical attack. PP is a plastic that has very low susceptibility to this.

Choose wisely

---

A white polypropylene surface may be more sensitive to stains than a black one. Polypropylene is quite a soft material and thus sensitive to scratches.

# Rubber

Used for Sticks

---

The rubber tree gave us wood, but before that, it gave us rubber of course! Sourced and locally manufactured in Sri Lanka, these rubber bases are the only products in our range that don't carry the 'Made in Belgium'-label, as we don't grow rubber trees in Belgium.

Choose wisely

---

Natural rubber has the color of pale skin. The black color is obtained by adding carbon, silica or carbon chalk before vulcanization. The carbon chalk can cause black stripes on the floor, but they can easily be removed.

# Concrete

Used for Inumbra - Inumbrina - Hopper shade - Kosmos shade

---

Concrete is a composite material composed of sand bonded with a fluid cement that hardens over time. Our concrete blocks are high-pressure moulded to make them stronger.

Choose wisely

---

Use concrete blocks, only if floor fastening is not possible.

# Fabrics & leathers

---

Yarn is produced by spinning raw fibers to produce long strands. Our textiles are formed by weaving or felting, sometimes coated with acryl, pvc or polyester in order to repel water and dirt. All fabrics are carefully considered and selected for their purpose in an outdoor environment.

## Sunbrella®

Used for AMAi - Bistroo - Captain's Chair - Gargantua - Hopper - Kosmos - Marina - Panigiri - Pantagruel - Sol+Luna - Tiki - Virus - Walrus

Sunbrella® is an acrylic fabric that is still known as the best outdoor fabric available for making cushions. The raw material is Sunbrella® solution-dyed acrylic fibre. The color pigments are locked right into the very heart of the fibres during the initial stage of the manufacturing process, before the yarn is even made Sunbrella® colors stand up to tough weather conditions and years of sun exposure.

Choose wisely

Our Sunbrella cushions and blankets are machine washable at low temperatures. A white and a colored cushion can both get dirty, but the white one will look dirtier sooner. Do not tumble dry.

## High-tech polyester

Used for AMAi - Inumbra - Inumbria - Hopper shade - Kosmos shade - Sol+Luna shade

Polyester is the most popular synthetic fibre in the world. The use of special finishing methods makes the fabrics weatherproof, water repellent, dirt repellent, lightfast, etc. High-tech polyester is used for a variety of "sun protection" purposes - from seat cushions to patio furniture through to awning fabrics. High water and UV resistance guarantees an excellent long-term appearance.

Choose wisely

Tree leaves, dust, CO2 emissions, pollution, bird droppings etc may leave marks on a spotless white fabric, so keep this in mind when choosing the perfect location for your shade.

## PU-coated polyester

Used for Acacia

Our PU-coated polyester fabric is a stretchable fabric that is suitable for outdoor use. The fabric water repellent, light weight and flexible. It's mainly used for camping tents, light duty covers, clothing and bags. The stretch quality of the fabric ensures that it never wrinkles.

Choose wisely

Tree leaves, dust, CO2 emissions, pollution, bird droppings etc may leave marks on a spotless white fabric, so keep this in mind when choosing the perfect location for your shade.

## Acrylic

Used for Sensu

This solution-died acrylic fabric is an extensively researched fabric that has been tested and proven to be very hard-wearing. A water-resistant coating prevents water from penetrating the fabric making it an all-weatherproof and long-lasting material.

Choose wisely

Our solution-died acrylic fabric is machine washable at low temperatures. The white and a colored fabric can both get dirty, but the white one will look dirtier sooner. Do not tumble dry.

# Sundance

Used for Walrus

---

Sundance upholstery is an extremely durable PVC material that does not absorb any water or dirt. This smooth, cleanable material keeps care and maintenance to a minimum.

Choose wisely

---

Tree leaves, dust, CO2 emissions, pollution, bird droppings etc. may leave marks on a spotless white fabric, so keep this in mind when choosing the perfect location for your sofa.

# Batyline

Used for Sol+Luna

---

The Batyline range represents the reference openwork material, which is selected by leading brands in office, hotel, restaurant, spa, yacht and cruise ship markets.

Choose wisely

---

Resistant, durable and aesthetic, Batyline is also a material that is extremely simple and easy to clean by simply washing with water or Extremis Multi Cleaner to restore the fabric's original appearance. Of course, a white fabric will be more delicate than most other colors, e.g. with sun cream.

# High-tech polyester

Used for Manille soft shade

---

This is a high-performance vinyl-coated polyester mesh that blocks up to 88% of solar radiation and 93% of the heat while allowing 28% natural light to pass through. Ideal for outdoor shades, it offers excellent outward visibility while maintaining optimal light and thermal comfort. Its Précontraint® technology ensures the fabric resists stretching and retains its shape even under extreme weather conditions. Additionally, it's mildew- and fire-resistant, making it a durable choice for long-term outdoor use.

Choose wisely

---

Resistant, durable and aesthetic, this is also a material that is extremely simple and easy to clean by simply washing with water or Extremis Multi Cleaner to restore the fabric's original appearance.

# Glamping tent fabric

Used for Manille fixed shade

---

Our Glampint tent fabric is a durable, flame-retardant roof membrane with a textured matte finish, ideal for luxury outdoor applications. With UV-resistant, dirt-repelling, and antibacterial properties, this fabric provides reliable protection while maintaining a sleek aesthetic. Built to withstand extreme temperatures, this perfectly suited for fixed outdoor structures, combining high-performance durability with long-lasting visual appeal.

Choose wisely

---

Resistant, durable and aesthetic, this is also a material that is extremely simple and easy to clean by simply washing with water or Extremis Multi Cleaner to restore the fabric's original appearance.

## Be the first to know

---

Facebook: [facebook.com/extremis.be](https://facebook.com/extremis.be)

LinkedIn: [linkedin.com/company/extremis](https://linkedin.com/company/extremis)

Pinterest: [pinterest.com/extremis](https://pinterest.com/extremis)

Instagram: [instagram.com/extremis](https://instagram.com/extremis)

Vimeo: [vimeo.com/extremis](https://vimeo.com/extremis)

Youtube: [youtube.com/user/EXTREMISdesign](https://youtube.com/user/EXTREMISdesign)

## Get in touch

---

### **Extremis HQ - Belgium**

Couthoflaan 20b  
8972 - Poperinge  
BELGIUM  
Tel. +32 57 34 60 20  
[info@extremis.com](mailto:info@extremis.com)  
[www.extremis.com](https://www.extremis.com)

Open from Monday to Friday  
8:30 till 12:30 and 13:00 till 17:00

### **Extremis Inc - North America**

Northland Drive NE 239  
MI 49341 Rockford  
UNITED STATES  
Tel. +1 415 7455768  
[na@extremis.com](mailto:na@extremis.com)

Available from Monday to Friday  
8:00 AM till 12:30 and 1:00 till 5:30 PM









