

KOSMOS

© *design by dirk wynants*

READ INSIDE

ASSEMBLY INSTRUCTIONS,
HOW TO USE, USEFUL TIPS
FOR KEEPING YOUR TOOL
FOR TOGETHERNESS IN
SHAPE

LANGUAGES

EN - NL

MORE

WWW.EXTREMIS.COM

PRODUCT

KOSMOS - KOSMOS WITH PARASOL - FREESTANDING TABLE -
MAINTENANCE

content	p. 3
assembly kosmos	p. 6
assembly with kosmos shade	p. 8
adjusting adjustable table	p. 10
covers	p. 11
bulb replacement	p. 12
onderhoud	p. 13
assembly freestanding table	p. 14

inhoud	p. 17
montage kosmos	p. 20
montage met kosmos shade	p. 22
bijregelen verstelbare kabel	p. 24
montage hoezen	p. 25
lamp vervangen	p. 26
onderhoud	p. 27
monatage vrijstaande tafel	p. 28

INHOUD

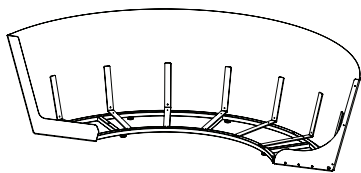

1 x left & right half of the seat
(low / high)

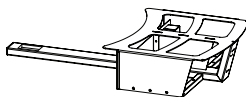

1 x small seat frame



1 x backrest
(low / high)

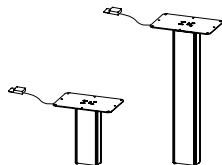

1 x adjustable table leg
fixed table leg



1 x tabletop



1 x tabletop cushion

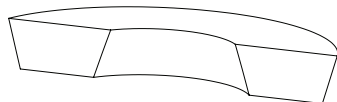

2 x large seating cushion



1 x small seating cushion



4 x large backrest cushion
(low / high)



3 x small backrest cushion
(low / high)

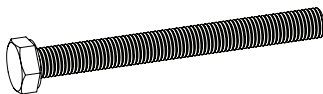

6 x bolt M8x80



6 x nut M8

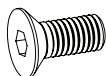

6 x bolt M6x14



6 x lock nut M6



5 x bolt M4x10

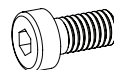

8 x bolt M6x12

OPTION

KOSMOS SHQDE

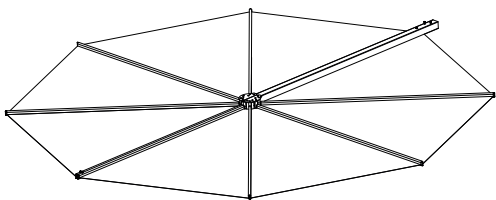

1 x shade frame with fabric



1 x vertical shade pole

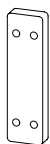

1 x plastic spacer



1 x cap 50 x 50

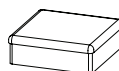

1 x cap 60 x 60

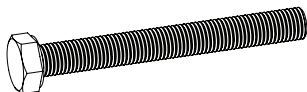

4 x bolt M8 x 70

ASSEMBLY KOSMOS

UTILITIES



2 people

screwdriver



+/- 45 min.

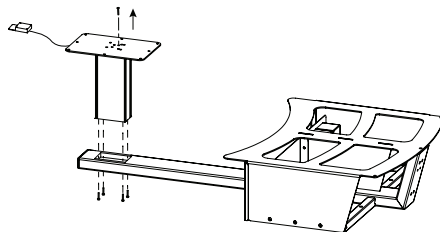
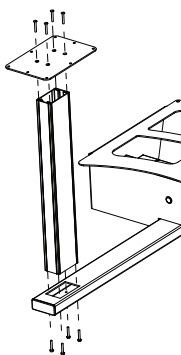

1. First mount the table leg to the small seat frame with 4 bolts M6x30. Now remove the transport screw.

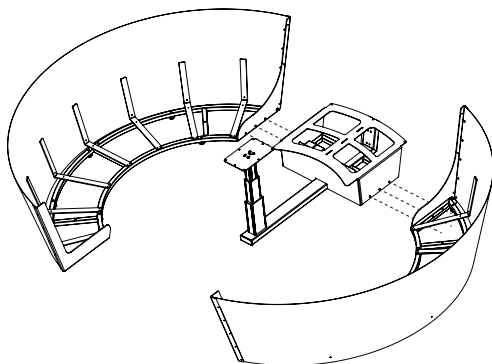

2. Now connect the two halves of the seat to the small seat frame using three bolts M6x80 and three M8 nuts. Attention: do not tighten them yet. Do not tighten them yet.

in case you bought a fixed table, first mount the aluminium profile to the small seat frame and the tabletop connection on top of it, with M6*30mm bolts.



Now unscrew the leveling feet that are not touching the ground surface from above with a flat screwdriver and further ensure that the whole is level.

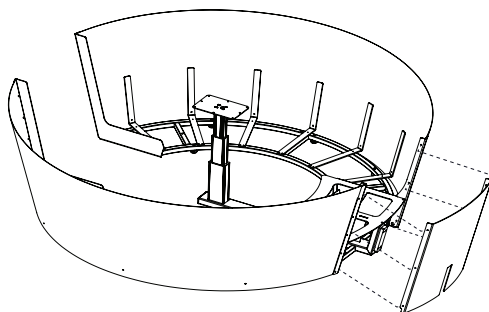

3. Place the backrest between the two seat halves and six M6x14 bolts and cap nuts. M6. Now tighten all the bolts.

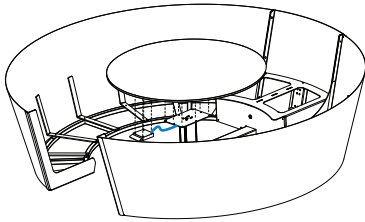

4. Screw the table top down with the countersunk screws M6x2. The control element for the height adjustment is fastened with 4 bolts M4x10 at the bottom of the table top. This control element must point towards the seat opening

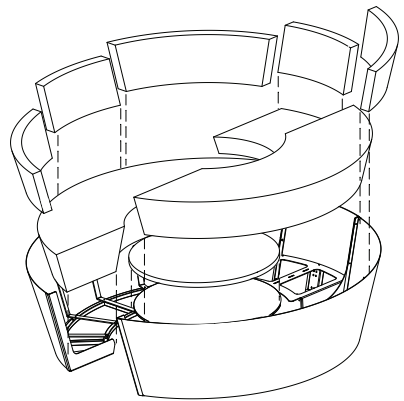

5. Now place the cushions in the Kosmos.

HOW DOES THE ADJUSTABLE TABLE WORK



To turn the table into a sofa bed, press the table down with your right hand while pressing the lever under the table top with your left. Always press in the middle of the tabletop, not on the edge.



To use the table again, you need to hold down the lever under the table top while pulling the table up with the other hand.

ASSEMBLY WITH KOSMOS SHADE

UTILITIES



2 people

screwdriver



+/- 45 min.

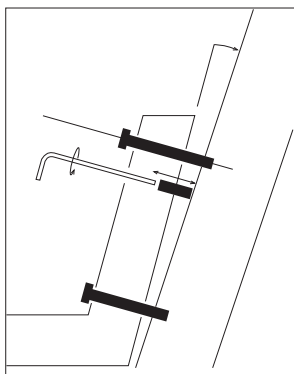

5. From the inside of the furniture, insert 4 bolts M8x70 through the holes provided (two at the bottom and two at the top). at the bottom and two at the top).

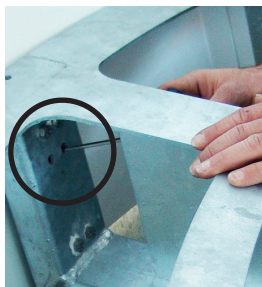

The two free openings are used to tilt the parasol slightly backwards in order to level the parasol cloth, by means of adjusting screws.

Follow the first 4 steps from pages 4-5.

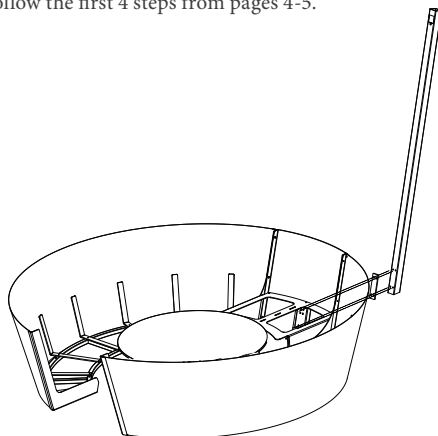

On the outside, then slide the plastic spacer Erover and then the parasol pole. Tighten firmly.

To do this, first unscrew the top bolts again a little looser until the ideal angle is reached, and then turn the set screws clockwise until against the vertical tube. Use a #4 Allen wrench to do this.

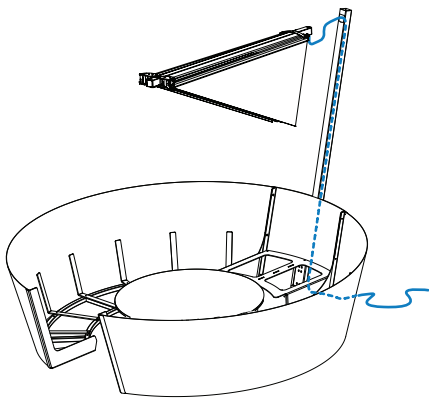

6. Take the parasol frame with cloth and go with the cord as close as possible to the end of the parasol pole. Lower the cord through the opening until it emerges at the bottom. After assembly, a certified electrician to fit the end of the cable with a suitable plug, with an appropriate plug.

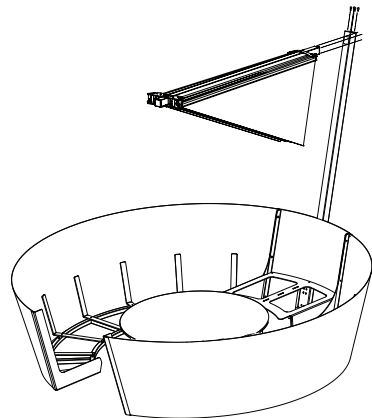

7. Now insert the parasol through the opening in the vertical tube until it locks in place and lock in place with bolts M6x12.

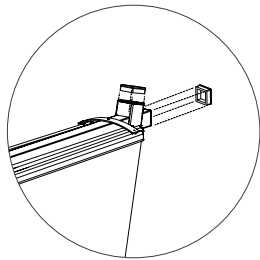

8. Install the appropriate caps on the parasol frame and the vertical tube. Now place the cushions in the Kosmos as in step 5 on page 5.

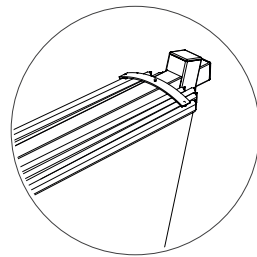

10. Now open the parasol. Does the magnetic lock not hold, first loosen the velcro strap and open the parasol again. Only now you can close the velcro again. In closed position one has to fix the leather strap on the umbrella frame to be attached to the two to the two outer ribs to prevent the parasol from opening.



This strap can also be used to hold the parasol open:
a) In case of rain: creates drains.

b) After not using the parasol for a long time: it is possible that the magnetic clasp does not hold temporarily, due to internal tension in the parasol fabric. If this is the case, please place the strap on the magnetic ribs as long as necessary in order to stretch the fabric again.



Optional: screw the lamp into its socket.

ADJUSTING ADJUSTABLE TABLE



1. Disassemble the valve by unscrewing the screws and turn the valve over.

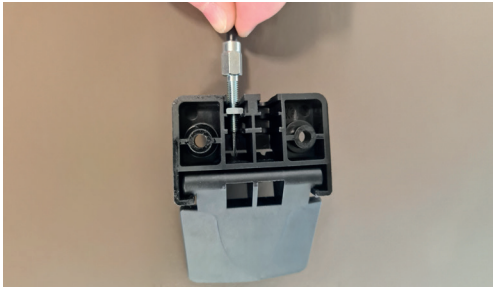

3. Check for any slack between the cable & mounting screw.



4. If so, turn the screw out until the play is gone & turn then continue for an additional 2 revolutions.



5. Make sure the screw is not fully extended.



6. Reassemble the lever using the screws you just removed. you have just unscrewed. If still not sufficient, repeat steps 1 - 3.

COVERS

TABLETOP COVER

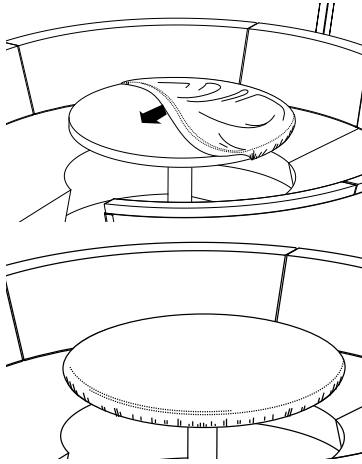

SHADE COVER

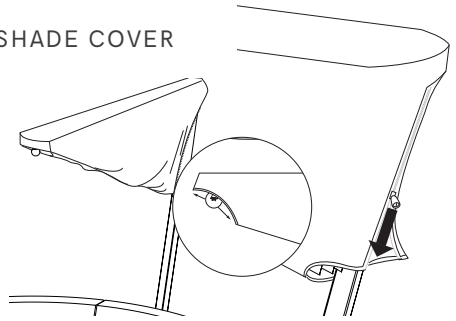

1. Slide the parasol cover over the closed parasol. If your parasol includes lighting, care should be taken to avoid breaking the lamp. break.
2. Close the zipper.

SEAT COVER

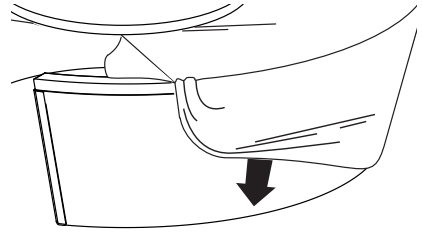
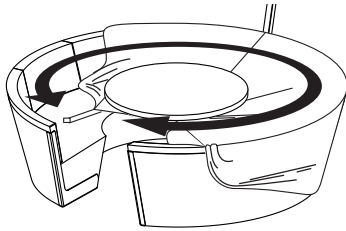

1. Make sure the cushions are nice and upright, and put the table to the highest position. Place the seat cover over the the Kosmos with the pie-shaped opening in the entrance of the seating unit. The table comes out above the cover, and the table leg sits in the tip of the pie piece.

2. Pull the side flap all the way up to the bottom of the of the furniture. Position the corner seams of the cover nicely on top of the corner piece.

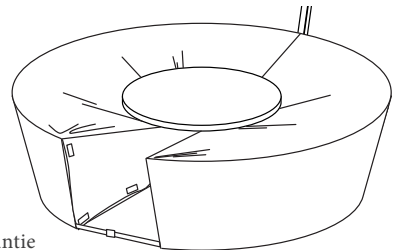
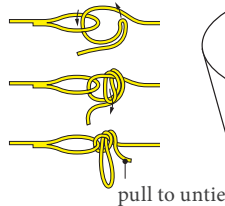
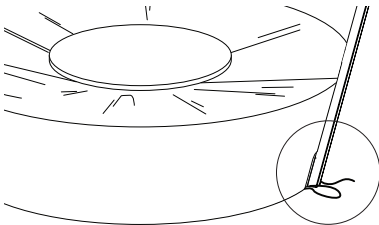

4. At the back of the Kosmos, tie the string attached, under the parasol pole. It is best to do this as described here.

5. Close at the front the velcro fasteners and the snap closure.

BULB REPLACEMENT

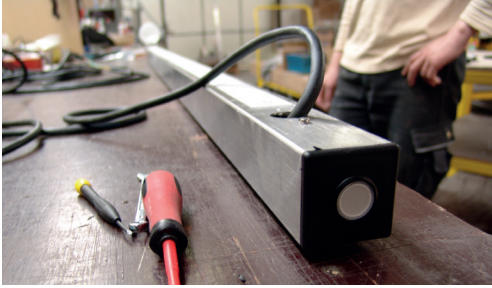

1. Remove the tube cap with switch and remove the LED adapter from the parasol tube.

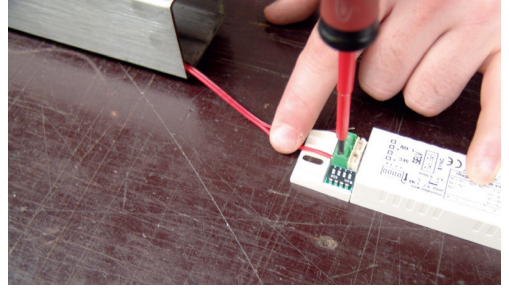

2. Remove the red and black cables from the adapter.

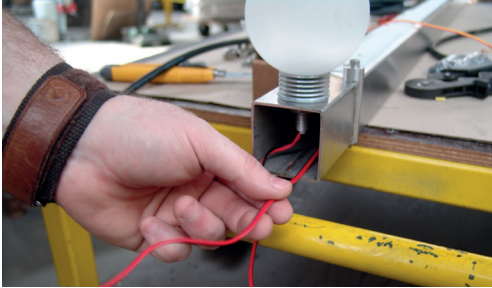

3. Remove the tube cap in the center of the parasol, pull the cord through the tube and unscrew the nut from the lighting base.

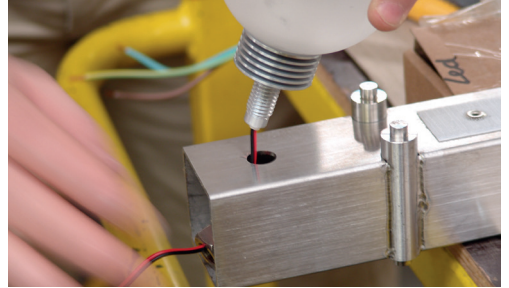

4. Remove the broken LED from the tube and twist the bulb off so that it can be attached to the new LED bulb. Do not forget to place the rubber ring to place it.

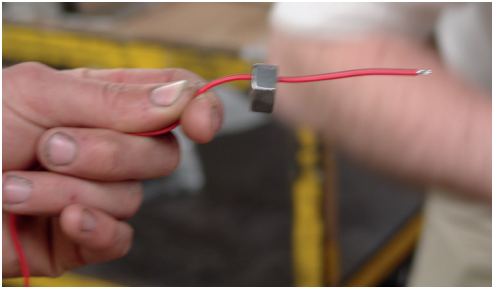

5. Insert the new LED, slide the nut over the cord, and tighten the nut. Insert the cable through the tube so that it emerges at the other end.

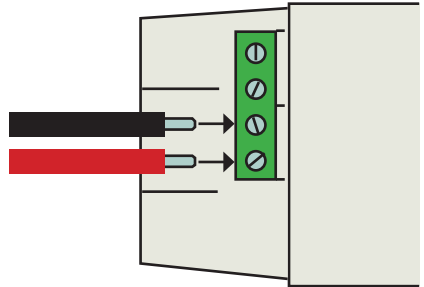

6. Connect the wires to the LED adapter as shown here shown.

7. Replace both caps on the ends of the parasol tube.

MAINTENANCE

CUSHIONS

Easily cleaned with warm water and a microfiber cloth. Do not use solvents, bleaches, abrasives, chemical detergents or waxes. For outdoor use, the optional cover should be placed over the entire furniture when not in use, as the cushions are not 100% waterproof for ventilation reasons.

The cushions should be cleaned regularly to preserve their appearance and to prevent the formation of dirt and bacteria.

Lacquers and inks, cleaning products, detergents and solvents such as thinner, acetone or alcohol can be very effective in removing stains, but cause direct damage and contribute to the deterioration of the material. The use of such cleaning agents is at your own risk

TABLETOP

HPL (high pressure laminate): can be cleaned with standard cleaners as one uses for the kitchen. For stubborn stains we use "HG plastic, paint and wallpaper intensive cleaner". For more info: www.hginternational.com

WARNING

Never sit on the backrest to avoid damage to the cushions and aluminum plate.



SHADE

Clean the parasol fabric and cover by rinsing with water and hand soap, and gently rubbing with a soft brush. Initially, make sure the parasol fabric does not get too dirty and place the cover over the parasol as much as possible.

Never spray the parasol with a high pressure cleaner.

Brush very gently, be extra careful on the seams, they can come loose with too hard friction.

After cleaning, the fabric has to be dried completely in open position.

Do not use detergents. These will damage the protective layer of the textile.

For stubborn stains, we recommend "awning, tarpaulin and tents refresher" of the brand 'HG'. See www.hg.eu for more info. Follow strictly the instructions on the bottle

Translated with [www.DeepL.com/Translator](http://www.DeepL.com/) (free version)!

WARNINGS

In case of strong winds or non-use, close the parasol and apply the cover to prevent the parasol from blowing open or becoming dirty.

Never leave the opened parasol unattended.

Do not leave the Kosmos parasol closed if it is not completely dry. Do not leave it closed for long periods in humid conditions.

If you do not use the parasol for a long time, store it as follows: perfectly dry in a dry environment.

content	p. 3
assembly kosmos	p. 6
assembly with kosmos shade	p. 8
adjusting adjustable table	p. 10
covers	p. 11
bulb replacement	p. 12
onderhoud	p. 13
assembly freestanding table	p. 14

inhoud	p. 17
montage kosmos	p. 20
montage met kosmos shade	p. 22
bijregelen verstelbare kabel	p. 24
montage hoezen	p. 25
lamp vervangen	p. 26
onderhoud	p. 27
monatage vrijstaande tafel	p. 28

INHOUD

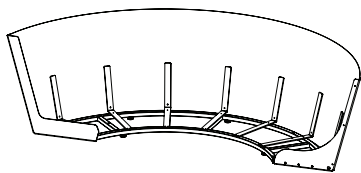

1 x linkse en rechtse zetelhelft
(laag of hoog)

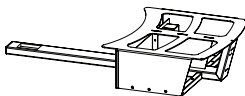

1 x zetelframe klein

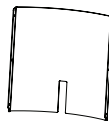

1 x rugsteun
(laag of hoog)

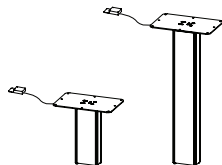

1 x verstelbare tafelpoot
of vaste tafelpoot



1 x tafelblad



1 x tafelkussen



2 x groot zitkussen



1 x klein zitkussen



4 x groot rugkussen
(laag of hoog)



3 x klein rugkussen
(laag of hoog)

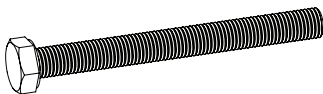

6 x vijs M8x80



6 x moer M8

4 x vijs M6x30 ???

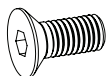

6 x vijs M6x14



6 x dopmoer M6



5 x vijs M4x10

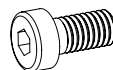

8 x vijs M6x12

OPTIONEEL

KOSMOS PARASOL

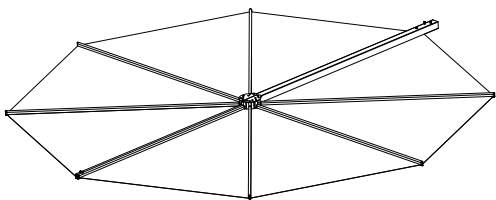

1 x parasolframe met doek



1 x parasolpaal

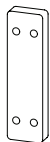

1 x plastic plaat



1 x dop 50 x 50

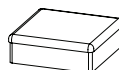

1 x dop 60 x 60

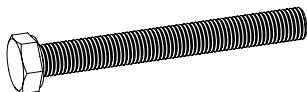

4 x bout M8 x 70

MONTAGE KOSMOS

BENODIGDHEDEN



2 personen

extremis sleutel

philips schroevendraaier



+/- 45 min.

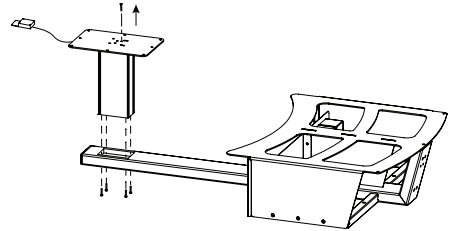
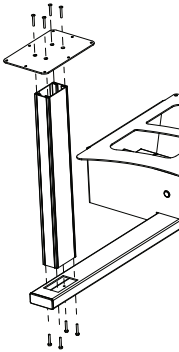

1. Monteer eerst de tafelpoot op het kleine zetelframe met 4 bouten M6x30. Verwijder nu de transportschroef.

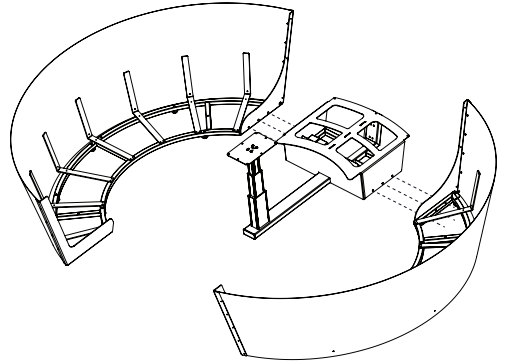

In geval van vaste tafelpoot: monteer eerst de lange rechthoekige buis op het kleine zetelframe en de tafelbladconnectie er bovenop, met bijgeleverde bouten M6 x 30.

2. Koppel nu de beide zetelhelften aan het kleine zetelframe met behulp van telkens drie bouten M6x80 en drie moeren M8. **Opgelet:** span deze nog niet aan.

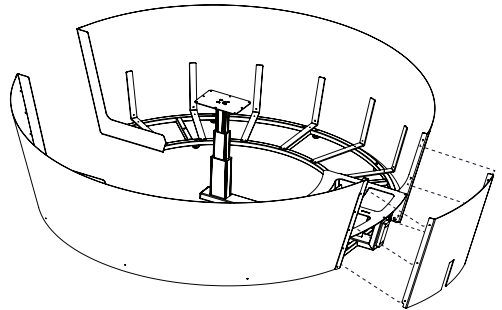

Draai nu de stelvoetjes die het grondoppervlak niet raken van bovenaf met een platte schroevendraaier uit en zorg verder dat het geheel waterpas komt te staan.

3. Plaats de rugsteun tussen de twee zetelhelften en schroef dit vast met zes bouten M6x14 en dopmoeren M6. Span nu alle bouten aan.

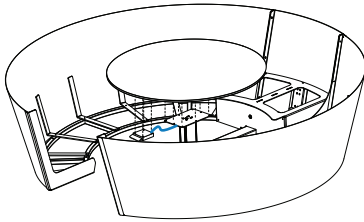

4. Schroef het tafelblad vast met de verzonken bouten M6x2. Het bedieningselement voor de hoogteinstelling wordt met 2 bouten M4x16 bevestigd onderaan het blad. Dit bedieningselement moet naar de zetelopening wijzen.

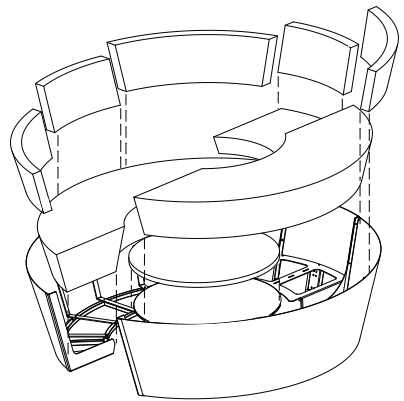

5. Plaats nu de kussens in de Kosmos.

WERKING VERSTELBAAR TAFELBLAD



Om van de tafel een zetelbed te maken, druk met de rechterhand de tafel naar beneden, terwijl je met links de **hendel onder het tafelblad indrukt**. Druk altijd in het midden van het tafelblad, en niet aan de rand.



Om opnieuw de tafel te gebruiken, dien je de **hendel onder het tafelblad ingedrukt te houden**, terwijl je met de andere hand het tafelblad mee omhoog helpt.

MONTAGE KOSMOS MET KOSMOS PARASOL

BENODIGDHEDEN



2 personen

extremis sleutel

philips schroevendraaier



+/- 45 min.

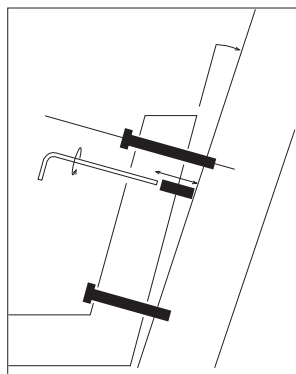

5. Steek langs de binnenkant van het meubel 4 bouten M8x70 door de daarvoor voorziene openingen (twee onderaan en twee bovenaan).



De twee vrije openingen dienen om de parasol iets naar achter te laten hellen en zo het parasoldoek waterpas te zetten, door middel van stelschroeven.

Volg de eerste 4 stappen van pagina's 4-5.

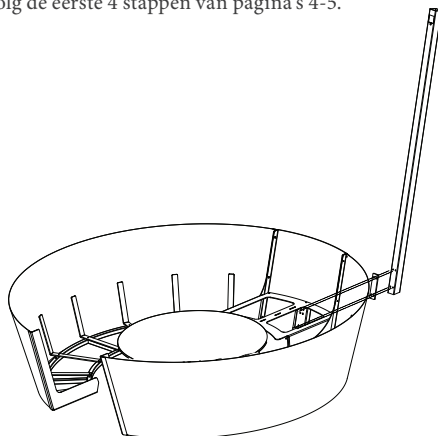

Schuif aan de buitenkant vervolgens de plastic afstandhouder Erover en vervolgens de parasolpaal. Draai goed aan.

Schroef hiervoor eerst de bovenste bouten weer wat losser tot de ideale hoek wordt bereikt, en draai vervolgens de stelschroefjes in wijzerzin tot tegen de verticale buis. Gebruik hiervoor een inbussleutel #4.

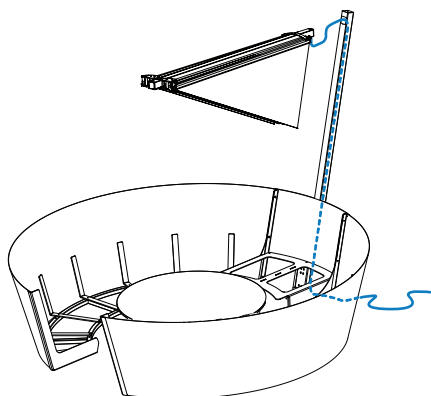

6. Neem het parasolframe met doek en ga met het snoer zo dicht mogelijk bij het uiteinde van de parasolpaal. Laat het snoer door de opening zakken tot het onderaan tevoorschijn komt. Na de montage dient een **erkend elektriciën** het uiteinde van de kabel te voorzien van een gepaste stekker.

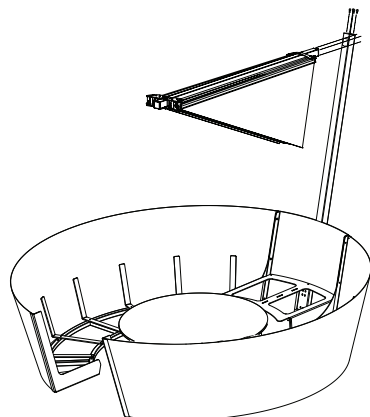

7. Steek nu de parasol door de opening in de verticale buis tot dit blokkeert en vergrendel met de bouten M6x12.

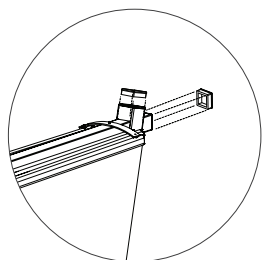

8. Monteer de passende doppen op het parasolframe en de verticale buis. Plaats nu de kussens in de Kosmos zoals in stap 5 op pagina 5.

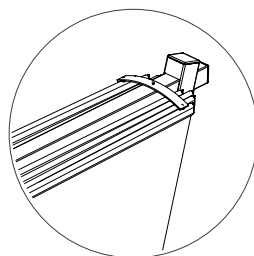

10. Open nu de parasol. Houdt de magneetsluiting het niet, maak dan eerst de velcroband los en open de parasol opnieuw. Pas nu mag je de velcroband opnieuw sluiten. In gesloten toestand dient men het lederen riempje op het parasolframe vast te maken aan de twee buitenste baleinen om te verhinderen dat de parasol open gaat.



Dit riempje kan ook gebruikt worden om de parasol open te houden:

a) Bij regen: creëert afvoerkanalen.

b) Na lange tijd de parasol niet gebruikt te hebben: mogelijks houdt de magneetsluiting het tijdelijk niet, door interne spanning in het parasoldoek. Plaats dan

zolang als nodig het riempje op de magnetische baleinen zodat de stof opnieuw wat rekt.

Optioneel: draai nu ook de lamp in de fitting.

BIJREGELLEN VERSTELBARE TAFEL

BENODIGDHEDEN



2 personen

extremis sleutel

philips schroevendraaier



+/- 45 min.



1. Demonteer de klep door de schroeven uit de draaien en draai de klep om.

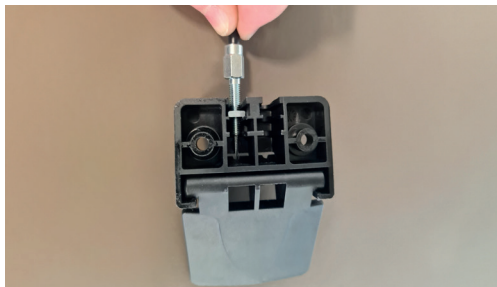

3. Controleer of er speling tussen de kabel & de bevestigingsschroef zit.



4. Zo ja, draai de schroef uit tot de speling weg is & draai dan nog 2 extra toeren verder.



5. **Let op** dat de schroef niet volledig uitgedraaid wordt.



6. Monteer de hendel opnieuw d.m.v. de schroeven die je daarnet uitgedraaid hebt. Indien nog niet voldoende, herhaal dan stap 1 - 3.

HOEZEN

TAFELHOES

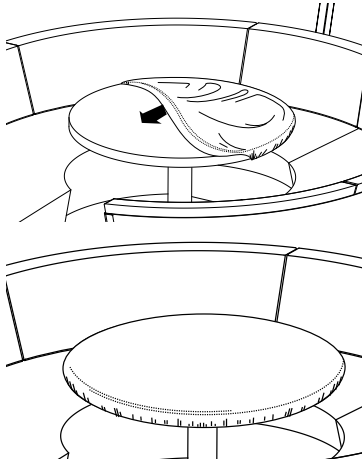

ZETELHOES

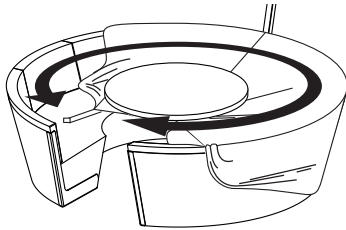

1. Zorg ervoor dat de kussens mooi rechtop staan, en zet het tafeltje in de hoogste stand. Leg de zetelhoes over de Kosmos met de taartvormige opening in de inkom van het zitmeubel. De tafel komt boven de hoes uit, en de tafelpoot zit in de punt van het taartstuk.

PARASOLHOES



1. Schuif de parasolhoes over de gesloten parasol. Indien uw parasol verlichting bevat, moet er zeker op gelet worden dit voorzichtig te doen, zodat de lamp niet breekt.
2. Sluit de rits.

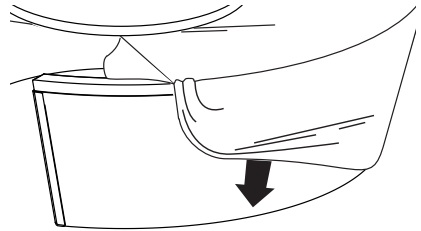

2. Trek de zijflap overal mooi strak tot aan de onderzijde van het meubel. Positioneer de hoeknaden van de hoes mooi bovenop het hoekstuk.

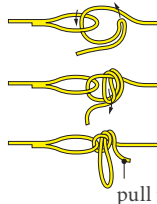
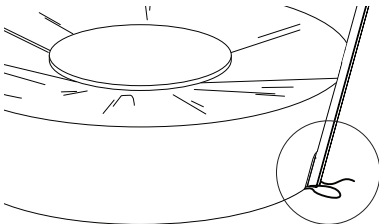

pull to untie

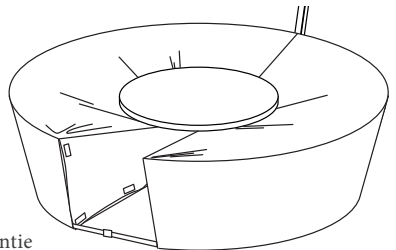

4. Knoop aan de achterkant van de Kosmos het touwtje vast, onder de parasolpaal. Het beste kan dit zoals hiernaast beschreven.

5. Sluit aan de voorzijde de velcrosluitingen en de kliksluiting.

LAMP VERVANGEN

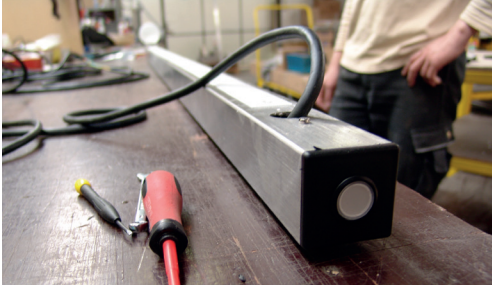

1. Verwijder de buisdop met schakelaar en haal de LED adapter uit de parasolbuis.

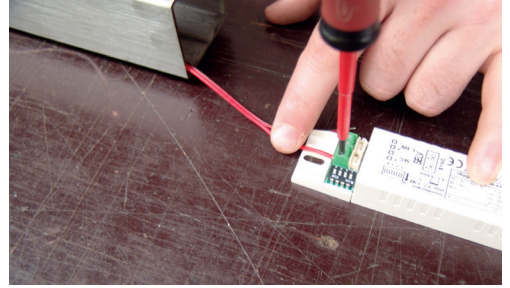

2. Haal het rode en het zwarte kabeltje uit de adapter.

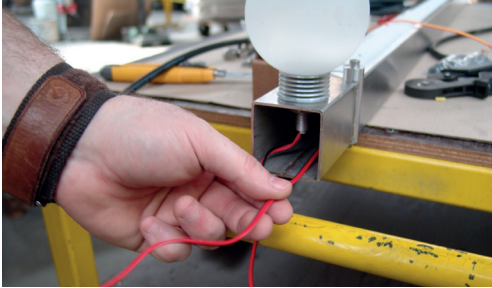

3. Verwijder de buisdop in het centrum van de parasol, trek het snoer doorheen de buis en draai de moer van de verlichtingssokkel los.

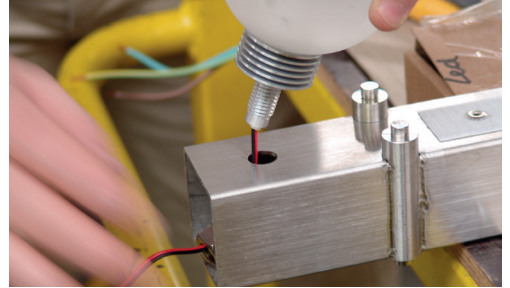

4. Verwijder de kapotte LED uit de buis en draai de bol er af, zodat deze op de nieuwe LED lamp bevestigd kan worden. Vergeet hierbij niet ook de rubberen ring te plaatsen.



5. Plaats de nieuwe LED, schuif de moer over het snoer, en span de moer aan. Steek de kabel door de buis zodat deze aan het andere uiteinde tevoorschijn komt.

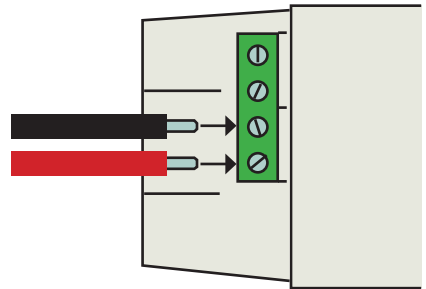

6. Verbind de kabeltjes met de LED adapter zoals hier afgebeeld.

7. Plaats beide doppen opnieuw op de uiteinden van de parasolbuis.

ONDERHOUD

KUSSENS

Eenvoudig te reinigen met warm water en een microvezeldoek. Gebruik geen solventen, bleekmiddelen, schuurmiddelen, chemische detergenten of waxen. **Bij buitentoepassing dient telkens de optionele hoes over het hele meubel geplaatst worden** wanneer dit niet in gebruik is, gezien de kussens om ventilatie redenen niet 100% waterdicht zijn.

De kussens moeten regelmatig gereinigd worden om zo hun uiterlijk te behouden en om de vorming van vuil en bacteriën tegen te gaan.

Lakken en inkten, schoonmaakmiddelen, wasmiddelen en oplosmiddelen zoals thinner, aceton of alcohol kunnen zeer effectief zijn in het verwijderen van vlekken, maar veroorzaken directe schade en dragen bij aan de verslechtering van het materiaal. Het gebruik van dergelijke reinigingsmiddelen is op eigen risico.

TAFEL

HPL (high pressure laminate): te reinigen met standaard reinigingsmiddelen zoals men gebruikt voor de keuken. Voor hardnekkige verontreinigingen gebruiken wij zelf "HG kunststof, verf en behang intensief reiniger". Voor meer info: www.hginternational.com

WAARSCHUWING

Ga nooit zitten op de rugleuning om beschadiging aan de kussens en de aluminiumplaat te vermijden.



PARASOL

Reinig het zeil van de parasol en de hoes door te spoelen met water en handzeep, en voorzichtig te wrijven met een zachte borstel. **Zorg er in eerste instantie voor dat de parasol stof niet te vuil wordt en plaats zo veel mogelijk de hoes over de parasol.**

Spuit de parasol nooit af met een hoge drukreiniger.

Borstel zeer zacht, wees extra voorzichtig op de naden, deze kunnen loskomen bij te harde wrijving.

Na het reinigen moet de stof volledig gedroogd worden in open toestand.

Gebruik geen detergenten. Deze tasten de bescherm laag van het textiel aan.

Bij hardnekkige vlekken raden wij aan 'zonnenscherm-,dekzeil- en tentenopfrisser' te gebruiken van het merk 'HG'. Zie www.hg.eu voor meer info. Volg strikt de instructies op de flacon!

WAARSCHUWING

Bij hevige wind of niet gebruik, sluit de parasol en breng de hoes aan om te vermijden dat de parasol open waait of vuil wordt.

Laat de geopende parasol nooit onbewaakt achter.

Laat de Kosmos parasol niet gesloten als ze niet volledig droog is. Laat ze niet gedurende lange tijd gesloten in vochtige omstandigheden.

Als u de parasol voor lange tijd niet gebruikt, berg ze dan op als volgt: perfect gedroogd in een droge omgeving.



Our headquarters:
Couthoflaan 20b
B-8972, Poperinge
info@extremis.com
+ 32 57 346020

www.extremis.com

Connect with us:



All rights reserved. Unless otherwise specified, all designs and photographs contained in this publication are copyright protected and are the property of Extremis. No part of this publication may be copied or distributed without Extremis' prior written consent. The names of the authors of photographs to which we do not hold rights are mentioned here. We have done our utmost to provide a comprehensive list of names. In the event of an alleged breach, please contact the editorial staff. © Extremis

20240627