

# extremis<sup>®</sup>

## Price list

€ — EN — 2024  
Recommended retail price ex. VAT









## **Tools for togetherness**

## Hi there!

---

Good design, ethical production and quality materials come at a fair price (list), and we should all be aware of that. However, in every minute of the design process, we do our absolute best to achieve the highest level of eco-efficiency by reducing transport volumes and waste. So, every tool for togetherness has a long history, even before it's being used by you. Designed logically and ecologically, solidly engineered after a thorough search and selection of quality materials, and then carefully made in Belgium. The result? An Extremis piece that you can love for a lifetime, something to pass on to the next generations. We are more than proud to welcome you to our price list.

	<p>ARE YOU SURE... this is the latest version? Check the expiry date on the next page, or go to <a href="http://www.extremis.com/pl">www.extremis.com/pl</a></p>
	<p>DEALER PORTAL Is the product in stock and ready to ship? Let's order it online! <a href="http://www.extremis.com/portal">www.extremis.com/portal</a></p>
	<p>PCON Don't forget, we are also on pCon planner. <a href="http://www.extremis.com/pcon">www.extremis.com/pcon</a></p> 

## Choose wisely

---

We offer great quality products, but every material has its own limits.

Don't expect wood to be perfectly smooth for years without any maintenance. After all, you don't expect your teeth to stay white if you don't brush them! Outdoor furniture also needs regular cleaning and some basic maintenance, especially in humid or polluted environments and if used intensively. Find out more in our materials section further on, or go to [www.extremis.com/maintenance](http://www.extremis.com/maintenance).

## We ♥ your project

---

If an order exceeds 5 pieces of one item, we consider it as a 'special' order. The lead time will differ from standard lead times, and other conditions might be applied to dimensions, colors or fabrics on request. There is one exception: our Sticks collection has a maximum standard order amount of 20 pieces of each item.

## Refurbishment tools







---

Every tool for togetherness has a long history, even before it's being used by you. Designed logically and ecologically, solidly engineered and made in Belgium with a selection of quality materials.

To extend the lifespan of our furniture even more, we offer spare parts. As every Extremis piece is designed with an efficient assembly process in mind, replacing a certain part is rather easy, and with straightforward videos that explain each step, you'll easily give a new life to your tool for togetherness. Find out more on [www.extremis.com/refurbishment](http://www.extremis.com/refurbishment)

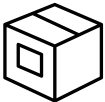
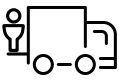
## General sales conditions

Because we hold a large number of components in stock and produce locally, most of the articles have short leadtimes.

<p>€ 4995 GAR001</p>	<p>Recommended retail price ex. VAT</p>
	<p>Customized item, payable in advance, ask for lead time</p>
	<p>Orders must be confirmed by Extremis. These confirmations are final and binding: check them and advise about possible mistakes within 24 hours.</p>
	<p>The Buyer cannot cancel, withdraw, or modify orders without Extremis' written permission. If such a request is approved, there will be an associated cost as outlined in our General Terms and Conditions of Sale (<a href="http://www.extremis.com/termsandconditions">www.extremis.com/termsandconditions</a>).</p>
	<p>Delivery is door-to-door on street level to the Extremis dealer's warehouse. Drop shipping to the B2C end user is not possible.</p>
	<p>For DAP deliveries, one driver and one truck tailgate are included. If you need extra services, you can request them for an additional fee using the rates listed on page 6.</p>
	<p>If you make changes to the delivery address after we confirm your order, an extra fee of € 75 will apply.</p>
	<p>If the Buyer provides an incorrect address, contact details or opening hours and our transport company has to make a second delivery attempt, there will be an additional charge of € 150.</p>
	<p>We may send products in disassembled form. It is the Buyer's responsibility to assemble and install the product with the help of specialized assemblers and follow the instructions provided by Extremis.</p>
	<p>We offer a standard 2-year warranty on all products. For more information about the full warranty, visit <a href="http://www.extremis.com/warranty">www.extremis.com/warranty</a>.</p>

# Transport

We understand the importance of convenience when it comes to transport, and that's why we have a comprehensive overview of our transport costs and services. We offer a variety of services and transport solutions that are tailored to all your needs, no matter how special. Take a look at the grid below for more information! Please note that these services will apply to every separate order. Transport costs and services ex. VAT.

	Belgium / The Netherlands / Luxemburg / Germany / Austria / Switzerland <sup>3</sup> / France	Italy <sup>2</sup> / Spain <sup>2</sup> / Portugal <sup>2</sup> / Denmark / Sweden / Norway <sup>3</sup> / Finland / UK <sup>3</sup> / Ireland	Rest of the world
<b>Incoterm</b>	DAP	DAP	FCA-A
<b>Free delivery as from net order value of</b>	€ 1500	€ 2500	
<b>Transport cost below the net order value</b>	€ 125 Temporarily € 0 via dealer portal	€ 250 Temporarily € 0 via dealer portal	

## ADDITIONAL TRANSPORT SERVICES

	Belgium / The Netherlands / Luxemburg / Germany / Austria / Switzerland <sup>3</sup> / France	Italy <sup>2</sup> / Spain <sup>2</sup> / Portugal <sup>2</sup> / Denmark / Sweden / Norway <sup>3</sup> / Finland / UK <sup>3</sup> / Ireland	Rest of the world
<b>Tailgate</b>	Included	Included	
<b>Forklift truck</b>	+ € 150	+ € 150	
<b>Change address</b>	+ € 75	+ € 75	
<b>Fixed day delivery</b>	+ € 500	+ € 500	
<b>Fixed day &amp; timeslot delivery</b>	+ € 650	+ € 650	
<b>Second delivery attempt</b>	+ € 150	+ € 150	
<b>Address not reachable with 18-m truck</b>	+ € 50	+ € 50	

## EXPORT DOCUMENTS

	Belgium / The Netherlands / Luxemburg / Germany / Austria / Switzerland <sup>3</sup> / France	Italy <sup>2</sup> / Spain <sup>2</sup> / Portugal <sup>2</sup> / Denmark / Sweden / Norway <sup>3</sup> / Finland / UK <sup>3</sup> / Ireland	Rest of the world
<b>Ex-1 Document<sup>3</sup></b>	€ 50 (Switzerland) Temporarily € 0 via dealer portal	€ 50 (UK / Norway) Temporarily € 0 via dealer portal	€ 50

## IMPORT DOCUMENTS



	Belgium / The Netherlands / Luxemburg / Germany / Austria / Switzerland <sup>3</sup> / France	Italy <sup>2</sup> / Spain <sup>2</sup> / Portugal <sup>2</sup> / Denmark / Sweden / Norway <sup>3</sup> / Finland / UK <sup>3</sup> / Ireland	Rest of the world
<b>Ex-1 Document</b>		€ 50 (UK / Norway)	

<sup>2</sup> Delivery to mainland only / Islands on request at extra charge

<sup>3</sup> UK, Switzerland & Norway: import duties and import customs clearance are not included



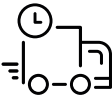



# Incoterms

Need to know which Incoterm applies to you? We've got you covered with an easy-to-understand grid that explains exactly what each Incoterm includes. Find the one that's applicable for your location and get the services you need.

	 Loading & export customs	 Carriage to destination	 Import customs clearance	 Import duties
DAP	✓	✓	✗	✗
FCA-A	✓	✗	✗	✗
EXW	✗	✗	✗	✗

# Icons explained

Look at these icons, they are amazing, and moreover, they'll give you some valuable information regarding our products.

	Return to index		I am parasol ready!
	Check availability, lead times & order online		I'm a perfect match with this table!
	Wheelchair accessible		Watch out, my pole is xxx mm thick
	Power options possible		



Acacia 10



AMAi 12



Anker 28



Bistroo 32

NEW OPTION



Captain's Chair 36



Deco cushions 40



Gargantua 42



Hopper bench 46



Hopper bench AA 46



Hopper combo 50



Hopper combo AA 51



Hopper picnic 54



Hopper picnic AA 56



Hopper shade 70



Inumbra 72



Inumbrina 74

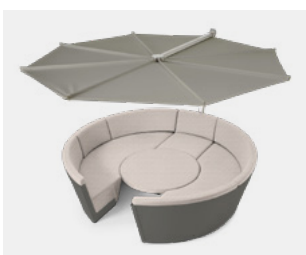

Kosmos 78



Kosmos shade 80

NEW

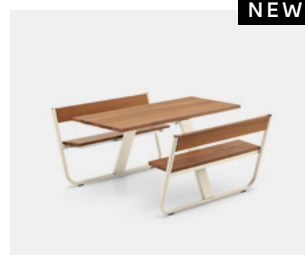

Manille 84



Marina combo 86





Marina picnic 88



Marina double desk 92



Marina table 94



Marina high table 96

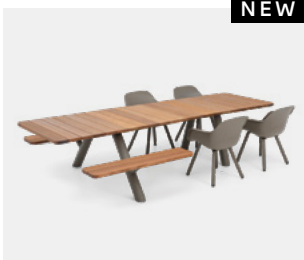

Panigiri combo 102

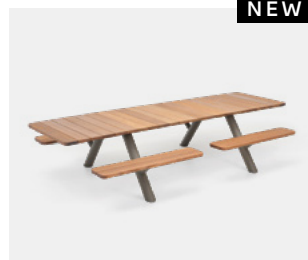

Panigiri picnic 102

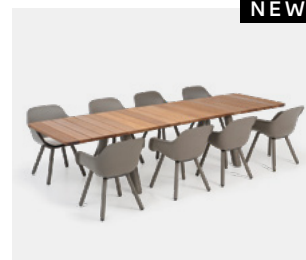

Panigiri table 102



Pantagruel picnic 108



Pantagruel table 112



Pantagruel high table 114



Picnik 118



Sensu 120



Sol+Luna 128



Sticks 134



Tiki 140



Tiki table 148



Virus 150



Walrus 156



Maintenance tools 182

**This is an interactive PDF**  
You can easily navigate from the index to the product pages, allowing you to smoothly jump from one page to the other. Our price list has never been more alive!

# Acacia

© design by Dirk Wynants

This compact, asymmetrical, Acacia-shaped umbrella fits the limited space of a balcony or small patio. Its clever design lets you create all the shade of a larger umbrella with a much reduced surface area. Simply use the handle and turn Acacia to the sun. Instead of closing the umbrella, simply remove the canvas and store it in the bag. What's left is a beautiful tree-like sculpture that can weather the year outdoors.

Add parasol base(s) or fix to the ground.



Check availability  
[www.extremis.com/portal](http://www.extremis.com/portal)



ø34 mm

Outer dimensions (l x w x h): 231 x 235 x 189/236 cm

White PU coated polyester fabric + Structured powder coated stainless steel pole & tubes + Galvanized steel foot to use as floor fastening

Storage bag for canopy included

		<b>OFF WHITE</b> RAL9002	<b>€ 1975</b> ACA447
		<b>VERDIGRIS</b> RGB 133 147 142	<b>€ 1975</b> ACA350
		<b>REED GREEN</b> RAL6013	<b>€ 1975</b> ACA351
		<b>COPPER BROWN</b> RAL8004	<b>€ 1975</b> ACA352
		<b>COLOR ON REQUEST</b> Only RAL colors Startup fee € 300 (ex. VAT)	<b>€ 2075</b> ACA357



## Friends of the product

Tiki table  
 standard tabletop



→ p148

Virus  
 standard tabletop



→ p150

## PARASOL BASE

Add a parasol base of your choice

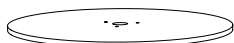

### LIGHTWEIGHT

1 galvanized steel base plate  
Recommended to combine with Virus & Tiki table  
ø 48 cm - 15 kg

€ 175

ACA010

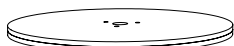

### STANDARD

2 galvanized steel base plates  
Can not be combined with Tiki table  
ø 48 cm - 30 kg

€ 350

ACA011



### HEAVY DUTY

3 galvanized steel base plates  
Can not be combined with Tiki table  
ø 48 cm - 45 kg

€ 525

ACA012

## ACACIA COMBINATIONS

With Virus & Tiki table

Acacia + Virus 3-seater



Acacia + Virus 4-seater



Acacia + Virus 5-seater



Acacia + Tiki table small



Acacia + Tiki table large

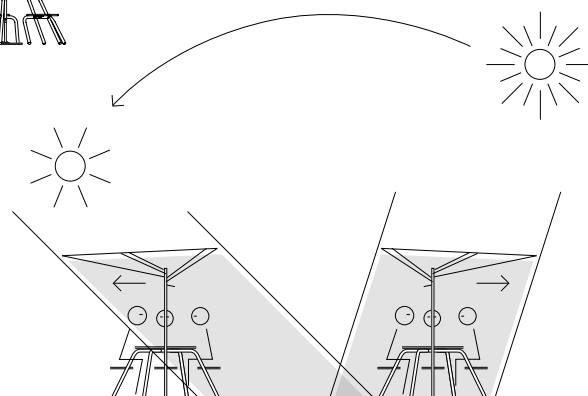

# AMAi galvanized

© design by Dirk Wynants

AMAi is the flexibility that you desire, all the time, indoors and outdoors. Two A-shaped side frames provide a solid construction where multifunctional magic finds its purpose. In between these frames, you can position the tabletop into two heights: standard or high. Thanks to the innovative design, even a single person can smoothly slide the tabletop from 'sitting height' into 'standing height' and vice versa.

Add more A-frames to extend togetherness into infinity. One AMAi seats 8 people and stands even more.



Check availability  
www.extremis.com/portal



Wheelchair accessible  
→ p178





## BASE MODULE

Outer dimensions (l x w x h): 304 x 113 x 230 cm

Galvanized steel A-frames, footrest & top tube

The side profiles of the tabletop are always structured powder coated aluminium Off white RAL9002

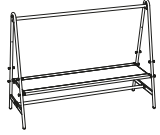
Hellwood = 100% PEFC

			 <b>OFF WHITE</b> RAL9002 Tabletop	  <b>HELLWOOD</b> Thermally treated wood Tabletop centerplate
		<b>GALVANIZED STEEL</b> A-frames, footrest & top tube	<b>€ 4080</b> AMA739	<b>€ 4340</b> AMA740





## EXTENSION MODULE

Outer dimensions (l x w x h): 298 x 113 x 230 cm

Galvanized steel A-frame, footrest & top tube

The side profiles of the tabletop are always structured powder coated aluminium Off white RAL9002

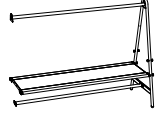
Hellwood = 100% PEFC

			 <b>OFF WHITE</b> RAL9002 Tabletop	  <b>HELLWOOD</b> Thermally treated wood Tabletop centerplate
		<b>GALVANIZED STEEL</b> A-frame, footrest & top tube	<b>€ 3150</b> AMA744	<b>€ 3410</b> AMA745

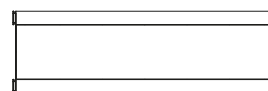

Powder coated tabletop

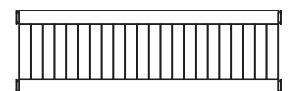

Hellwood tabletop



## Friends of the product

AMAi  
benches



→ p27

Captain's Chairs



→ p36

Tiki stool  
& bar stool



→ p140

### ADD-ON TABLE

Outer dimensions (l x w): 87 x 40 cm

Structured powder coated aluminium

Can be used in both the standard & high position

	<b>OFF WHITE</b> RAL9002	<b>€ 775</b> AMA711
	<b>COLOR ON REQUEST</b> Only RAL colors Startup fee € 300 (ex. VAT)	<b>€ 815</b> AMA066

### MONITOR HOLDER

VESA connection for computer monitor, not for a television

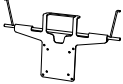
	Stainless steel	<b>€ 200</b> AMA068
---	-----------------	------------------------

### TABLETOP FIXATION

Can only be combined when the tabletop is in the highest position

	Stainless steel 1 set: 4 pieces	<b>€ 240/set</b> AMA067
---	------------------------------------	----------------------------

### STANDARD FEET

	Black 1 set: 2 pieces	<b>€ incl.</b>
---	--------------------------	----------------

### LEVELING FEET

We advise to use these for uneven surfaces

You need 1 set for every A-frame

	Black 1 set: 2 pieces	<b>€ 75/set</b> AMA070
---	--------------------------	---------------------------

### FLOOR FASTENING FEET

Can also be added to the AMAi bench

You need 1 set for every A-frame | Height adjustable

Anchoring materials not included

	Stainless steel 1 set: 2 pieces	<b>€ 400/set</b> AMA069
---	------------------------------------	----------------------------





# AMAi powder coated

© design by Dirk Wynants

AMAi is the flexibility that you desire, all the time, indoors and outdoors. Two A-shaped side frames provide a solid construction where multifunctional magic finds its purpose. In between these frames, you can position the tabletop into two heights: standard or high. Thanks to the innovative design, even a single person can smoothly slide the tabletop from 'sitting height' into 'standing height' and vice versa.

Add more A-frames to extend togetherness into infinity. One AMAi seats 8 people and stands even more.



-  Check availability  
[www.extremis.com/portal](http://www.extremis.com/portal)
-  Wheelchair accessible  
 → p178
-  Power options  
 → p16
-  Shades → p17  
 Accessories → p18







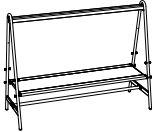

## BASE MODULE

Outer dimensions (l x w x h): 304 x 113 x 230 cm

Structured powder coated stainless steel A-frames & aluminium top profile + Galvanized steel footrest

The side profiles of the tabletop are always structured powder coated aluminium

Hellwood = 100% PEFC

	 <b>POWDER COATED</b> <i>Tabletop</i>	  <b>HELLWOOD</b> <i>Thermally treated wood                      Tabletop centerplate</i>
 <b>BLACK</b> RAL9005 A-frames & top profile	<b>€ 4690</b> AMA019	<b>€ 4950</b> AMA018
 <b>BEACH BEIGE</b> RAL1019 A-frames & top profile	<b>€ 4690</b> AMA653	<b>€ 4950</b> AMA645
 <b>OFF WHITE</b> RAL9002 A-frames & top profile	<b>€ 4690</b> AMA686	<b>€ 4950</b> AMA688
 <b>COPPER BROWN</b> RAL8004 A-frames & top profile	<b>€ 4690</b> AMA025	<b>€ 4950</b> AMA024
 <b>COLOR ON REQUEST</b> Only RAL-colors A-frames & top profile Startup fee € 300 (ex. VAT)	<b>€ 4920</b> AMA028	<b>€ 5190</b> AMA027

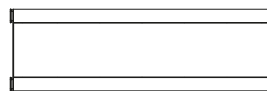

Powder coated tabletop

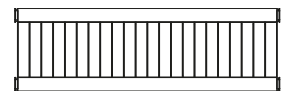

Hellwood tabletop



## Friends of the product

**AMAi benches**



→ p27

**Captain's Chairs**



→ p36

**Tiki stool & bar stool**



→ p140









## EXTENSION MODULE

Outer dimensions (l x w x h): 298 x 113 x 230 cm

Structured powder coated stainless steel A-frame & aluminium top profile + Galvanized steel footrest



The side profiles of the tabletop are always structured powder coated

Hellwood = 100% PEFC

	 <b>POWDER COATED</b> <i>Tabletop</i>	 <b>HELLWOOD</b> <i>Thermally treated wood</i> <i>Tabletop centerplate</i>	
	<b>BLACK</b> RAL9005 A-frame & top profile	<b>€ 3580</b> AMA031	<b>€ 3840</b> AMA030
	<b>BEACH BEIGE</b> RAL1019 A-frame & top profile	<b>€ 3580</b> AMA699	<b>€ 3840</b> AMA701
	<b>OFF WHITE</b> RAL9002 A-frame & top profile	<b>€ 3580</b> AMA698	<b>€ 3840</b> AMA700
	<b>COPPER BROWN</b> RAL8004 A-frame & top profile	<b>€ 3580</b> AMA037	<b>€ 3840</b> AMA036
	<b>COLOR ON REQUEST</b> Only RAL-colors A-frames & top profile Startup fee € 300 (ex. VAT)	<b>€ 3755</b> AMA040	<b>€ 4025</b> AMA039

## FOOTREST

\* Leaving the collection. Available while supplies last

		Galvanized steel	<b>€ incl.</b>
		Stainless steel *	<b>€ 215</b> AMA208

## HOW DO I GET THE CORRECT PRODUCT CODE FOR MY LIGHTING MODULE?

Complement the dots with the correct code mentioned below

 <b>SHUKO</b> <i>Europe type F</i>	 <b>UNITED KINGDOM</b> <i>Type G</i>	 <b>SWITZERLAND</b> <i>Type J</i>
.....SO	.....UK	.....CH



## LIGHTING & ELECTRICITY MODULE - OUTDOOR & INDOOR

Outer dimensions (l x w x h): 290 x 10 x 5 cm

2 warm white dimmable LED lights (3000 K) of each 84 cm long in the center of the profile

Can be added afterwards, slides into the top profile | Can not be combined with the galvanized steel top tube

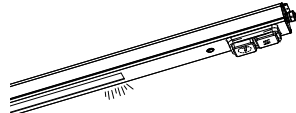
Wireless smart lighting control with the Casambi App (Europe)

 	<b>BLACK</b> Powder coated aluminium RAL9005 2 LED lights + 2 sockets + 2 USB ports (1 USB & 1 USB-C)	<b>€ 2755</b> AMA060...
---	--	----------------------------

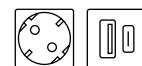
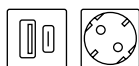

## POWER SUPPLY

One cable can power 4 AMAi modules. Consult Extremis when using several heating or kitchen appliances

In countries where this type of plug is not used, a different plug will need to be fitted

Up to max. 3500 W

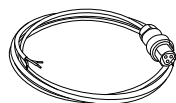
	IP65 500 cm	<b>€ 70</b> AMA054
---	----------------	-----------------------



## SHADE









Outer dimensions (l x w): 282 x 301 cm

White high-tech polyester fabric + Galvanized steel or Stainless steel tubes | 3 waves on both sides

Fixates underneath the top profile | Can not be combined with the galvanized steel A-frame

Includes an extra powder coated profile at both sides for water drainage

\* Leaving the collection. Available while supplies last

	 <b>GALVANIZED STEEL</b> <i>Tubes</i>	 <b>STAINLESS STEEL *</b> <i>Tubes - AISI 316</i>
	<b>BLACK</b> Profiles RAL9005 & White fabric € 1850 AMA124	<b>€ 1850</b> AMA079
	<b>BEACH BEIGE</b> Profiles RAL1019 & White fabric € 1850 AMA130	<b>€ 1850</b> AMA657
	<b>OFF WHITE</b> Profiles RAL9002 & White fabric € 1850 AMA131	<b>€ 1850</b> AMA706
	<b>COPPER BROWN</b> Profiles RAL8004 & White fabric € 1850 AMA125	<b>€ 1850</b> AMA080
	<b>COLOR ON REQUEST</b> Only RAL-colors (Profiles) Startup fee € 300 (ex. VAT) € 1945 AMA126	<b>€ 1945</b> AMA081

## MARKET SHADE









Outer dimensions (l x w x h): 282 x 301 x 23 cm

White high-tech polyester fabric + Galvanized steel or Stainless steel tubes | 3 waves & 1 extra sun protection flap on both sides

Fixates underneath the top profile | Can not be combined with the galvanized steel A-frame

Includes an extra powder coated profile at both sides for water drainage

\* Leaving the collection. Available while supplies last







	 <b>GALVANIZED STEEL</b> <i>Tubes</i>	 <b>STAINLESS STEEL *</b> <i>Tubes - AISI 316</i>
	<b>BLACK</b> Profiles RAL9005 & White fabric € 2150 AMA127	<b>€ 2150</b> AMA082
	<b>BEACH BEIGE</b> Profiles RAL1019 & White fabric € 2150 AMA133	<b>€ 2150</b> AMA710
	<b>OFF WHITE</b> Profiles RAL9002 & White fabric € 2150 AMA132	<b>€ 2150</b> AMA709
	<b>COPPER BROWN</b> Profiles RAL8004 & White fabric € 2150 AMA128	<b>€ 2150</b> AMA083
	<b>COLOR ON REQUEST</b> Only RAL-colors (Profiles) Startup fee € 300 (ex. VAT) € 2260 AMA129	<b>€ 2260</b> AMA084

## ADD-ON TABLE

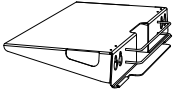
Outer dimensions (l x w): 87 x 40 cm

Structured powder coated aluminium

Can be used in both the standard & high position

		<b>BLACK</b> RAL9005	<b>€ 775</b> AMA063
		<b>BEACH BEIGE</b> RAL1019	<b>€ 775</b> AMA712
		<b>OFF WHITE</b> RAL9002	<b>€ 775</b> AMA711
		<b>COPPER BROWN</b> RAL8004	<b>€ 775</b> AMA064
		<b>COLOR ON REQUEST</b> Only RAL colors Startup fee € 300 (ex. VAT)	<b>€ 815</b> AMA066

## MONITOR HOLDER

VESA connection for computer monitor, not for a television

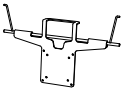
	Stainless steel	<b>€ 200</b> AMA068
--	-----------------	------------------------

## HANGING HOOK

Ideal to hang plants, cables, ...

Can not be combined with the galvanized steel top tube

	Stainless steel	<b>€ 75</b> AMA106
---	-----------------	-----------------------

## TABLETOP FIXATION

Can only be combined when the tabletop is in the highest position

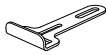
	Stainless steel 1 set: 4 pieces	<b>€ 240/set</b> AMA067
---	------------------------------------	----------------------------

## STANDARD FEET



Black  
1 set: 2 pieces

€ incl.

## LEVELING FEET

We advise to use these for uneven surfaces  
You need 1 set for every A-frame



Black  
1 set: 2 pieces

€ 75/set  
AMA070

## FLOOR FASTENING FEET

Can also be added to the AMAi bench  
You need 1 set for every A-frame | Height adjustable  
Anchoring materials not included

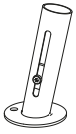

Stainless steel  
1 set: 2 pieces

€ 400/set  
AMA069

# AMAI catering station © design by Dirk Wynants

The AMAi catering station is your ultimate party wingman. No more running back and forth to the kitchen while your guests wonder where you've gone. This convenient prep table, with integrated plate storage, lets you put the final touches on appetizers right where the fun is. With the optional bar add-on, you can elevate the experience with a high-top area for drinks. And when it's time to raise a toast, the optional glass holder makes sure your wine glasses are just an arm's length away.



 Check availability  
www.extremis.com/portal







 Power options  
→ p22

 Shades → p23  
Accessories → p24

## BASE MODULE

Outer dimensions (l x w x h): 304 x 113 x 230 cm







Structured powder coated stainless steel A-frames + Structured powder coated aluminium top profile & tabletop + Galvanized steel footrest

		<b>BLACK</b> RAL9005	<b>€ 6050</b> AMA089
		<b>BEACH BEIGE</b> RAL1019	<b>€ 6050</b> AMA650
		<b>OFF WHITE</b> RAL9002	<b>€ 6050</b> AMA713
		<b>COPPER BROWN</b> RAL8004	<b>€ 6050</b> AMA090
		<b>COLOR ON REQUEST</b> Only RAL colors Startup fee € 300 (ex. VAT)	<b>€ 6345</b> AMA092

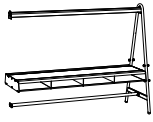
## EXTENSION MODULE

Outer dimensions (l x w x h): 298 x 113 x 230 cm

Structured powder coated stainless steel A-frame + Structured powder coated aluminium top profile & tabletop + Galvanized steel footrest

		<b>BLACK</b> RAL9005	<b>€ 4940</b> AMA093
		<b>BEACH BEIGE</b> RAL1019	<b>€ 4940</b> AMA655
		<b>OFF WHITE</b> RAL9002	<b>€ 4940</b> AMA715
		<b>COPPER BROWN</b> RAL8004	<b>€ 4940</b> AMA094
		<b>COLOR ON REQUEST</b> Only RAL colors Startup fee € 300 (ex. VAT)	<b>€ 5180</b> AMA096



### Friends of the product

Captain's Chairs  
high

→ p36



Tiki  
bar stool

→ p140









### BAR ADD-ON

Outer dimensions (l x w x h): 286 x 31 x 37 mm



Structured powder coated aluminium tabletop & supports

Only possible in combination with the AMAi catering station

		<b>BLACK</b> RAL9005	<b>€ 1500</b> AMA097
		<b>BEACH BEIGE</b> RAL1019	<b>€ 1500</b> AMA651
		<b>OFF WHITE</b> RAL9002	<b>€ 1500</b> AMA716
		<b>COPPER BROWN</b> RAL8004	<b>€ 1500</b> AMA098
		<b>COLOR ON REQUEST</b> Only RAL colors Startup fee € 300 (ex. VAT)	<b>€ 1575</b> AMA100
<b>GLASSHOLDER</b> Outer dimensions (l x w x h): 72 x 13 x 7 cm		Stainless steel	<b>€ 150</b> AMA101

### FOOTREST

\* Leaving the collection. Available while supplies last

		Galvanized steel	<b>€ incl.</b>
		Stainless steel *	<b>€ 215</b> AMA208

### AMAI CATERING STATION

The perfect height to cook or prepare delicious meals and drinks, with convenient storage accessible from all sides.

### AMAI CATERING STATION + BAR ADD-ON

With the bar piece in place, you easily create a high apero corner to share delicious togetherness with friends while having the space to prepare more drinks and bites. Add the stackable Tiki bar stools for extra comfort.

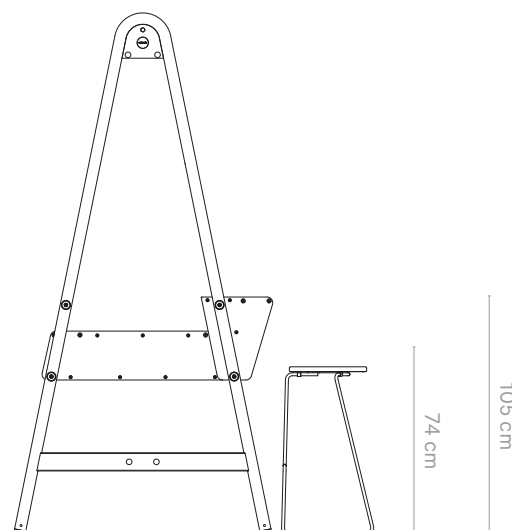
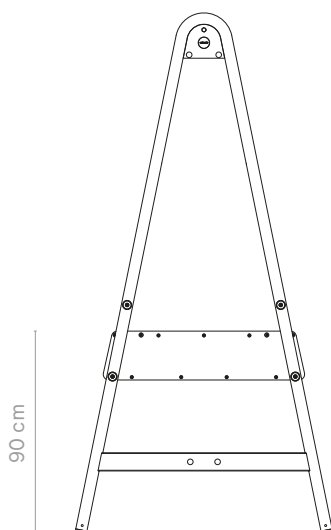

## HOW DO I GET THE CORRECT PRODUCT CODE FOR MY LIGHTING MODULE?

Complement the dots with the correct code mentioned below

 <b>SHUKO</b> <i>Europe type F</i>	 <b>UNITED KINGDOM</b> <i>Type G</i>	 <b>SWITZERLAND</b> <i>Type J</i>
.....SO	.....UK	.....CH

## LIGHTING & ELECTRICITY MODULE - OUTDOOR & INDOOR

Outer dimensions (l x w x h): 290 x 10 x 5 cm

2 warm white dimmable LED lights (3000 K) of each 84 cm long in the center of the profile

Can be added afterwards, slides into the top profile | Can not be combined with the galvanized steel top tube

Wireless smart lighting control with the Casambi App (Europe)

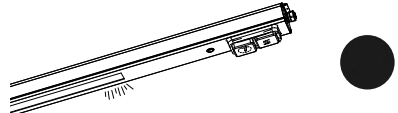
	<b>BLACK</b> Powder coated aluminium RAL9005 2 LED lights + 2 sockets + 2 USB ports (1 USB & 1 USB-C)	<b>€ 2755</b> AMA060...
--	--	----------------------------

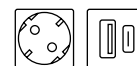
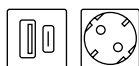

## POWER SUPPLY

One cable can power 4 AMAi modules. Consult Extremis when using several heating or kitchen appliances

In countries where this type of plug is not used, a different plug will need to be fitted

Up to max. 3500 W

	IP65 500 cm	<b>€ 70</b> AMA054
---	----------------	-----------------------

## SHADE









Outer dimensions (l x w): 282 x 301 cm

White high-tech polyester fabric + Galvanized steel or Stainless steel tubes | 3 waves on both sides

Fixates underneath the top profile | Can not be combined with the galvanized steel A-frame

Includes an extra powder coated profile at both sides for water drainage

\* Leaving the collection. Available while supplies last

	 <b>GALVANIZED STEEL</b> <i>Tubes</i>	 <b>STAINLESS STEEL *</b> <i>Tubes - AISI 316</i>
	<b>BLACK</b> Profiles RAL9005 & White fabric <b>€ 1850</b> AMA124	<b>€ 1850</b> AMA079
	<b>BEACH BEIGE</b> Profiles RAL1019 & White fabric <b>€ 1850</b> AMA130	<b>€ 1850</b> AMA657
	<b>OFF WHITE</b> Profiles RAL9002 & White fabric <b>€ 1850</b> AMA131	<b>€ 1850</b> AMA706
	<b>COPPER BROWN</b> Profiles RAL8004 & White fabric <b>€ 1850</b> AMA125	<b>€ 1850</b> AMA080
	<b>COLOR ON REQUEST</b> Only RAL-colors (Profiles) Startup fee € 300 (ex. VAT) <b>€ 1945</b> AMA126	<b>€ 1945</b> AMA081

## MARKET SHADE









Outer dimensions (l x w x h): 282 x 301 x 23 cm

White high-tech polyester fabric + Galvanized steel or Stainless steel tubes | 3 waves & 1 extra sun protection flap on both sides

Fixates underneath the top profile | Can not be combined with the galvanized steel A-frame

Includes an extra powder coated profile at both sides for water drainage

\* Leaving the collection. Available while supplies last







	 <b>GALVANIZED STEEL</b> <i>Tubes</i>	 <b>STAINLESS STEEL *</b> <i>Tubes - AISI 316</i>
	<b>BLACK</b> Profiles RAL9005 & White fabric <b>€ 2150</b> AMA127	<b>€ 2150</b> AMA082
	<b>BEACH BEIGE</b> Profiles RAL1019 & White fabric <b>€ 2150</b> AMA133	<b>€ 2150</b> AMA710
	<b>OFF WHITE</b> Profiles RAL9002 & White fabric <b>€ 2150</b> AMA132	<b>€ 2150</b> AMA709
	<b>COPPER BROWN</b> Profiles RAL8004 & White fabric <b>€ 2150</b> AMA128	<b>€ 2150</b> AMA083
	<b>COLOR ON REQUEST</b> Only RAL-colors (Profiles) Startup fee € 300 (ex. VAT) <b>€ 2260</b> AMA129	<b>€ 2260</b> AMA084

### ADD-ON TABLE

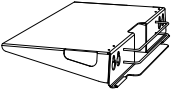
Outer dimensions (l x w): 87 x 40 cm

Structured powder coated aluminium

Can be used in both the standard & high position

		<b>BLACK</b> RAL9005	<b>€ 775</b> AMA063
		<b>BEACH BEIGE</b> RAL1019	<b>€ 775</b> AMA712
		<b>OFF WHITE</b> RAL9002	<b>€ 775</b> AMA711
		<b>COPPER BROWN</b> RAL8004	<b>€ 775</b> AMA064
		<b>COLOR ON REQUEST</b> Only RAL colors Startup fee € 300 (ex. VAT)	<b>€ 815</b> AMA066

### MONITOR HOLDER

VESA connection for computer monitor, not for a television

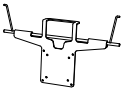
	Stainless steel	<b>€ 200</b> AMA068
--	-----------------	------------------------

### HANGING HOOK

Ideal to hang plants, cables, ...

Can not be combined with the galvanized steel top tube

	Stainless steel	<b>€ 75</b> AMA106
---	-----------------	-----------------------



### STANDARD FEET



Black  
1 set: 2 pieces

€ incl.

### LEVELING FEET

We advise to use these for uneven surfaces  
You need 1 set for every A-frame



Black  
1 set: 2 pieces

€ 75/set  
AMA070

### FLOOR FASTENING FEET

Can also be added to the AMAi bench  
You need 1 set for every A-frame | Height adjustable  
Anchoring materials not included

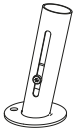

Stainless steel  
1 set: 2 pieces

€ 400/set  
AMA069

# AMAi benches

© design by Dirk Wynants

Minimalistic and lightweight, yet sturdy and weatherproof, the AMAi benches match the unique design of the AMAi table, while also fitting a wide range of settings on their own. Opt for a fixed low bench or for a height-adjustable bench that follows the chosen table height of AMAi. Sit on the bench at traditional height or flip the backrest to the other side to create a high bench to lean against.









Check availability  
[www.extremis.com/portal](http://www.extremis.com/portal)

## BENCH

Outer dimensions (l x w x h): 249 x 40 x 46/51 cm

Structured powder coated stainless steel legs & Structured powder coated aluminium bench top  
 4 to 5 people

		<b>BLACK</b> RAL9005	<b>€ 1345</b> AMA071
		<b>BEACH BEIGE</b> RAL1019	<b>€ 1345</b> AMA662
		<b>OFF WHITE</b> RAL9002	<b>€ 1345</b> AMA718
		<b>COPPER BROWN</b> RAL8004	<b>€ 1345</b> AMA072
		<b>COLOR ON REQUEST</b> Only RAL colors Startup fee € 300 (ex. VAT)	<b>€ 1415</b> AMA074



### Friends of the product

AMAi  
 galvanized



→ p12

AMAi  
 powder coated









→ p14

## HILO BENCHES

Outer dimensions (l x w x h)

Structured powder coated stainless steel legs & Structured powder coated aluminium bench top & adjustable backrest









		 <b>SHORT</b> 117 x 40 x 46/75 cm 2 people	 <b>LONG</b> 249 x 40 x 46/75 cm 4 to 5 people
	<b>BLACK</b> RAL9005	€ 1775 AMA075	€ 1965 AMA102
	<b>BEACH BEIGE</b> RAL1019	€ 1775 AMA669	€ 1965 AMA734
	<b>OFF WHITE</b> RAL9002	€ 1775 AMA723	€ 1965 AMA730
	<b>COPPER BROWN</b> RAL8004	€ 1775 AMA076	€ 1965 AMA103
	<b>COLOR ON REQUEST</b> Only RAL colors Startup fee € 300 (ex. VAT)	€ 1870 AMA078	€ 2070 AMA105

## BACKREST CUSHIONS FOR HILO BENCHES

Outer dimensions (l x t)

Sunbrella upholstery for the backrest of the HiLo benches

Please store the cushions inside when not in use

		 <b>SHORT</b> 99 x 2 cm	 <b>LONG</b> 233 x 2 cm
	<b>GREY CHINÉ</b> Sunbrella® Natté	€ 165 AMA107	€ 350 AMA112
	<b>COCONUT</b> Sunbrella® Savane	€ 165 AMA671	€ 350 AMA748
	<b>MARBLE</b> Sunbrella® Lopi	€ 225 AMA108	€ 450 AMA113
	<b>COLOR ON REQUEST 1</b> Only for Sunbrella Natté, Solids, Savane & Heritage	€ 190 AMA109	€ 375 AMA114
	<b>COLOR ON REQUEST 2</b> Only for Sunbrella Chartres	€ 215 AMA110	€ 425 AMA115
	<b>COLOR ON REQUEST 3</b> Only for Sunbrella Lopi, Domino & Zori	€ 250 AMA111	€ 475 AMA116

# Anker

© design by Dirk Wynants

Anker is our answer to a growing need for optimal use of space. The compact 6-seater picnic table encourages one-on-one conversations, but its appearance invites people to come on board. Just slide in at the sides of the benches, without having to lift your leg. The solid frame is very robust and weather resistant. Configure Anker as you wish: choose galvanized steel or a powder coated finish, combined with Hellwood or Iroko hardwood tabletop and benches.



 Check availability  
[www.extremis.com/portal](http://www.extremis.com/portal)







 Power options  
 → p30

 ø35 mm

## GALVANIZED STEEL LEGS

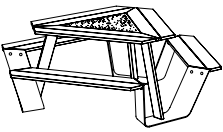
Outer dimensions (ø x h): 217 x 74 cm

Powder coated centerplate

		 <b>HELLWOOD</b> <i>Thermally treated wood          tabletop &amp; benches</i>	 <b>IROKO</b> <i>Tropical hardwood          tabletop &amp; benches</i>	
		<b>GALVANIZED BL</b> & Black centerplate RAL9005	<b>€ 4155</b> ANK008	<b>€ 4265</b> ANK002
		<b>GALVANIZED EA</b> & Earth centerplate RGB 88 88 84	<b>€ 4155</b> ANK009	<b>€ 4265</b> ANK001
		<b>GALVANIZED OW</b> & Off white centerplate RAL9002	<b>€ 4155</b> ANK355	<b>€ 4265</b> ANK354
		<b>GALVANIZED VE</b> & Verdigris centerplate RGB 133 147 142	<b>€ 4155</b> ANK312	<b>€ 4265</b> ANK311



### Friends of the product

Inumbrina  
 medium

→ p75











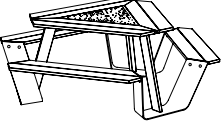

### POWDER COATED LEGS

Outer dimensions (ø x h): 217 x 74 cm

The centerplate is powder coated in the same color as the legs

			 <b>HELLWOOD</b> <i>Thermally treated wood tabletop &amp; benches</i>	 <b>IROKO</b> <i>Tropical hardwood tabletop &amp; benches</i>
		<b>BLACK</b> RAL9005	<b>€ 4255</b> ANK011	<b>€ 4365</b> ANK004
		<b>EARTH</b> RGB 88 88 84	<b>€ 4255</b> ANK012	<b>€ 4365</b> ANK005
		<b>OFF WHITE</b> RAL9002	<b>€ 4255</b> ANK353	<b>€ 4365</b> ANK351
		<b>VERDIGRIS</b> RGB 133 147 142	<b>€ 4255</b> ANK310	<b>€ 4365</b> ANK308
		<b>COLOR ON REQUEST</b> Only RAL colors Startup fee € 300 (ex. VAT)	<b>€ 4400</b> ANK014	<b>€ 4510</b> ANK007

### FLOOR FASTENING

Anchoring materials not included

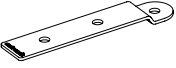
	Stainless steel 1 set: 3 pieces	<b>€ 145/set</b> ANK015
---	------------------------------------	----------------------------

### CONNECTION PIECE

To combine with Inumbrina medium

	Galvanized steel	<b>€ 115</b> ANK331
---	------------------	------------------------

### WIRELESS POWER - OUTDOOR & INDOOR

Outer dimensions (ø): 8 cm

Wireless charger on top, compatible with all devices with wireless charging system

It has a quick charge system | One battery included



2 x USB on battery pack  
Battery 55 wh - Antenna 5w  
IP65 & Shockproof

**€ 395**  
ELE001

### CHARGING TRAY FOR WIRELESS POWER

Outer dimensions (l x w x h): 24 x 8 x 9 cm

Charges up to four stations simultaneously in 7 hours | 4 charging slots

Includes magnetic key to remove the station from its support

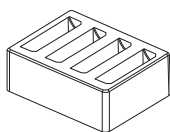

For Europe

**€ 280**  
ELE002

For United Kingdom

**€ 280**  
ELE003



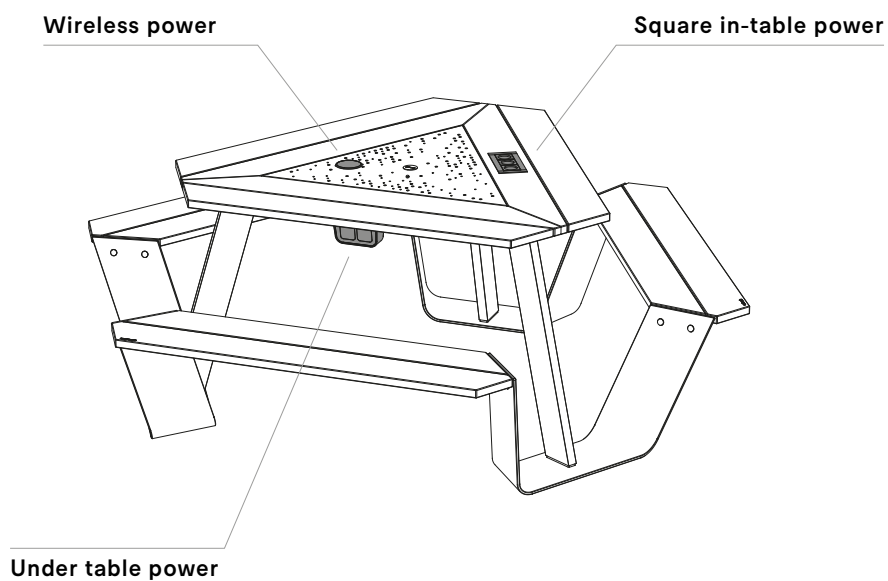

For United States

**€ 280**  
ELE004



## HOW DO I GET THE CORRECT PRODUCT CODE FOR MY POWER MODULE?

Complement the dots with the correct code mentioned below



 <b>SHUKO</b> <i>Europe type F</i>	 <b>UNITED STATES</b> <i>Type B</i>	 <b>UNITED KINGDOM</b> <i>Type G</i>	 <b>SWITZERLAND</b> <i>Type J</i>
.....SO	.....US	.....UK	.....CH

## UNDER TABLE POWER - INDOOR USE ONLY

Outer dimensions (l x w x h): 14 x 8 x 8 cm

Caution, no plug is supplied with the 3-meter cable as there are different types of plugs and sockets around the globe

To be fixed underneath the tabletop

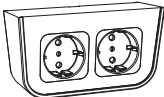
		 <b>WHITE</b>	 <b>BLACK</b>
	<b>2 X SOCKETS</b>	<b>€ 130</b> ELE007...	<b>€ 130</b> ELE009...
	<b>SOCKET + USB</b> USB & USB-C	<b>€ 240</b> ELE006...	<b>€ 240</b> ELE008...

## SQUARE IN-TABLE POWER - INDOOR USE ONLY

Outer dimensions (l x w): 19 x 8 cm

Caution, no plug is supplied with the 3-meter cable as there are different types of plugs and sockets around the globe

Cut-out in tabletop included

		<b>3 X SOCKET</b> Black	<b>€ 310</b> ELE010...
		<b>2 X SOCKET + USB</b> Black USB & USB-C	<b>€ 420</b> ELE011...

# Bistroo

© design by Dirk Wynants

Bistroo is an innovative, practical, weatherproof two-seater dining set. The clever three-legged design makes it perfectly stable on any surface, and, what is more, it is easier to stack and lock away than individual tables and chairs. Structured, powder coated metals are combined with clever features and accessories. Bistroo is ideally suited for small spaces and feels right at home against the backdrop of a cozy, compact restaurant or on a small city balcony.



Check availability  
[www.extremis.com/portal](http://www.extremis.com/portal)



Power options  
 → p34

Outer dimensions (l x w x h): 116 x 94 x 88 cm

Purse hanger & stacking spacer included









Structured powder coated aluminium tabletop, seats & backrests + stainless steel legs

		<b>OFF WHITE</b> RAL9002	<b>€ 1820</b> BIS408
		<b>VERDIGRIS</b> RGB 133 147 142	<b>€ 1820</b> BIS348
		<b>REED GREEN</b> RAL6013	<b>€ 1820</b> BIS349
		<b>COPPER BROWN</b> RAL8004	<b>€ 1820</b> BIS350
		<b>COSMIC CREAM</b> RAL1015	<b>€ 1820</b> BIS410
		<b>COBALT BLUE</b> RAL5013	<b>€ 1995</b> BIS352
		<b>SUN YELLOW</b> RAL1032	<b>€ 1995</b> BIS409
		<b>PISTACHE</b> RAL6021	<b>€ 1995</b> BIS407
		<b>COLOR ON REQUEST</b> Only RAL colors Startup fee € 300 (ex. VAT)	<b>€ 1910</b> BIS355



## CUSHIONS

Outer dimensions (ø x h): 34 x 1,5 cm - 1 piece  
Please store the cushions inside when not in use

		<b>GREY CHINÉ</b> Sunbrella® Natté	<b>€ 95</b> VRS757
		<b>DARK TAUPE</b> Sunbrella® Natté	<b>€ 95</b> VRS758
		<b>MARBLE</b> Sunbrella® Lopi	<b>€ 115</b> VRS756
		<b>CHARCOAL</b> Sunbrella® Lopi	<b>€ 115</b> VRS755
		<b>LEAF GREEN</b> Sunbrella® Heritage	<b>€ 95</b> VRS761
		<b>INDIGO</b> Sunbrella® Heritage	<b>€ 95</b> VRS762
		<b>LOTO</b> Sunbrella® Domino	<b>€ 115</b> VRS760
		<b>CRAPS</b> Sunbrella® Domino	<b>€ 115</b> VRS759

## TABLE TRAY

Outer dimensions (l x w): 24 x 21 cm  
It fits seamlessly in the crevice of the tabletop

	Oiled Bamboo	<b>€ 65</b> BIS019
---	--------------	-----------------------

## FLOOR FASTENING

Anchoring materials not included

	Stainless steel 1 set: 3 pieces	<b>€ 95/set</b> BIS024
---	------------------------------------	---------------------------

## WIRELESS POWER - OUTDOOR & INDOOR

Outer dimensions (ø): 8 cm

Wireless charger on top, compatible with all devices with wireless charging system

It has a quick charge system | One battery included



2 x USB on battery pack  
Battery 55 wh - Antenna 5w  
IP65 & Shockproof

**€ 395**  
ELE001

## CHARGING TRAY FOR WIRELESS POWER

Outer dimensions (l x w x h): 24 x 8 x 9 cm

Charges up to four stations simultaneously in 7 hours | 4 charging slots

Includes magnetic key to remove the station from its support

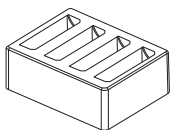

For Europe

**€ 280**  
ELE002

For United Kingdom

**€ 280**  
ELE003

For United States

**€ 280**  
ELE004

Wireless power

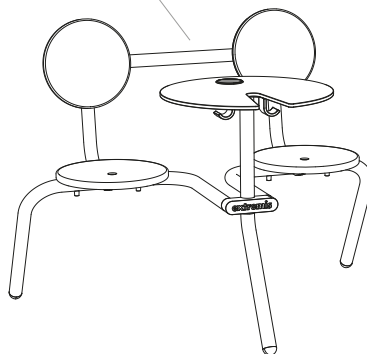

## POPULAR FABRIC COMBINATIONS

Numerous color combinations are possible

To make life easier, we have created several color combinations, carefully composed following Extremis' color concepts.

Need any help finding the right color combination?

Go check our Biomes on page 175

### Out of the Fjordinary

*A boreal and montane togetherness biome*



Bistroo

**Pistache**

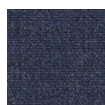

Cushions

**Indigo**

### Forest & Fields

*A green and rural togetherness biome*



Bistroo

**Reed green**



Cushions

**Charcoal**

### A Lotta Terracotta

*A mediterranean togetherness biome*



Bistroo

**Copper brown**

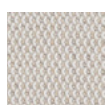

Cushions

**Marble**

### Majestic Mirage

*A sandy and breezy togetherness biome*



Bistroo

**Sun yellow**



Cushions

**Loto**

# Captain's Chair

© design by Metrica

The Captain's Chair owes its name to its shape, which draws inspiration from yacht helm chairs. It's a shell chair offering unrivalled seating comfort. Thanks to this variety of frames, the chair can be used in all kinds of environments: public spaces, private homes, indoors, outdoors, etc. It is perfectly suited for terraces, patios, hotels, restaurants, pubs, offices, dining rooms, meeting rooms, bars and lounges, to name but a few possibilities.

Combine a shell + legs to compose your favorite Captain's Chair.



Check availability  
[www.extremis.com/portal](http://www.extremis.com/portal)

## SHELL

Reinforced polypropylene shell

Legs not included, choose your legs on the next pages

\* Leaving the collection. Available while supplies last

		<b>BLACK</b> RAL9005	<b>€ 165</b> CAP002
		<b>EARTH</b> RGB 88 88 84	<b>€ 165</b> CAP271
		<b>BEACH BEIGE</b> RAL1019	<b>€ 165</b> CAP348
		<b>OFF WHITE</b> RAL9002	<b>€ 165</b> CAP347
		<b>PAPYRUS WHITE *</b> RAL9018	<b>€ 165</b> CAP270
		<b>VERDIGRIS</b> RGB 133 147 142	<b>€ 165</b> CAP269
		<b>REED GREEN</b> RAL6013	<b>€ 165</b> CAP264



## Friends of the product

AMAI



→ p12

Hopper  
 combo (AA)



→ p50

Marina  
 combo



→ p88

Marina  
 double desk



→ p92

Marina  
 table



→ p94

Marina  
 high table



→ p96

Panigiri  
 combo & table



→ p102

Pantagruel  
 high table









→ p114

## CUSHIONS

Please store the cushions inside when not in use





\* Leaving the collection. Available while supplies last

		<b>GREY CHINÉ</b> Sunbrella® Natté	<b>€ 145</b> CAP304
		<b>DARK TAUPE</b> Sunbrella® Natté	<b>€ 145</b> CAP305
		<b>MARBLE</b> Sunbrella® Lopi	<b>€ 175</b> CAP303
		<b>CHARCOAL</b> Sunbrella® Lopi	<b>€ 175</b> CAP302
		<b>LEAF GREEN</b> Sunbrella® Heritage	<b>€ 145</b> CAP307
		<b>RUST *</b> Sunbrella® Heritage	<b>€ 145</b> CAP306

## PIPE LEGS

Outer dimensions (l x w x h): 61 x 63 x 82 cm







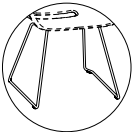

Structured powder coated stainless steel legs

		<b>BLACK</b> RAL9005	<b>€ 285</b> CAP030
		<b>EARTH</b> RGB 88 88 84	<b>€ 285</b> CAP031
		<b>BEACH BEIGE</b> RAL1019	<b>€ 285</b> CAP032
		<b>OFF WHITE</b> RAL9002	<b>€ 285</b> CAP033

## SLIDING LEGS

Outer dimensions (l x w x h): 62 x 63 x 82 cm

Galvanized steel or Structured powder coated zinced steel legs







		<b>GALVANIZED STEEL</b>	<b>€ 205</b> CAP205
		<b>BLACK</b> RAL9005	<b>€ 220</b> CAP230
		<b>EARTH</b> RGB 88 88 84	<b>€ 220</b> CAP276
		<b>BEACH BEIGE</b> RAL1019	<b>€ 220</b> CAP333
		<b>OFF WHITE</b> RAL9002	<b>€ 220</b> CAP329
		<b>VERDIGRIS</b> RGB 133 147 142	<b>€ 220</b> CAP268
		<b>REED GREEN</b> RAL6013	<b>€ 220</b> CAP275
		<b>COPPER BROWN</b> RAL8004	<b>€ 220</b> CAP286

## HIGH SLIDING LEGS

Outer dimensions (l x w x h): 60 x 63 x 114 cm

Galvanized steel or Structured powder coated zinc steel legs

\* Leaving the collection. Available while supplies last

		<b>GALVANIZED STEEL *</b>	<b>€ 300</b> CAP207
		<b>BLACK</b> RAL9005	<b>€ 320</b> CAP232
		<b>EARTH</b> RGB 88 88 84	<b>€ 320</b> CAP281
		<b>PAPYRUS WHITE *</b> RAL9018	<b>€ 320</b> CAP278
		<b>VERDIGRIS *</b> RGB 133 147 142	<b>€ 320</b> CAP279

## PROTECTION FEET WITH FELT

For delicate floors | Indoor use only

Only for Sliding & High sliding legs

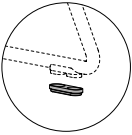
	1 set: 4 pieces	<b>€ 10/set</b> CAP245
--	-----------------	---------------------------

# Deco cushions

Combining two smaller sized deco cushions will upgrade your Extremis products. Besides adding extra comfort, they add coziness and a warm, homelike touch. Both available in a broad range of colors, that allows you to add a personal touch to your indoor or outdoor furniture setting. From a contrasting cheerful color combination to a more balanced ton-sur-ton look, whatever suits your personal style!









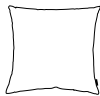

 Check availability  
[www.extremis.com/portal](http://www.extremis.com/portal)

## CUSHIONS

Outer dimensions (l x h x t)

Please store the cushions inside when not in use

			
		<b>LUMBAR CUSHION</b> 30 x 50 x 17 cm	<b>DECO CUSHION</b> 50 x 50 x 17 cm
	<b>GREY CHINÉ</b> Sunbrella® Natté	€ 75 WAL440	€ 100 WAL123
	<b>DARK TAUPE</b> Sunbrella® Natté	€ 75 WAL410	€ 100 WAL122
	<b>COCONUT</b> Sunbrella® Savane	€ 75 WAL407	€ 100 WAL394
	<b>MARBLE</b> Sunbrella® Lopi	€ 95 WAL408	€ 120 WAL395
	<b>CHARCOAL</b> Sunbrella® Lopi	€ 95 WAL409	€ 120 WAL396
	<b>SOOTY</b> Sunbrella® Chartres	€ 85 WAL441	€ 110 WAL132
	<b>LEAF GREEN</b> Sunbrella® Heritage	€ 75 WAL413	€ 100 WAL130
	<b>MOSS</b> Sunbrella® Heritage	€ 75 WAL415	€ 100 WAL400



### Friends of the product

Kosmos

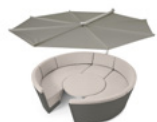

→ p78

Sol+Luna



→ p128

Walrus



→ p156











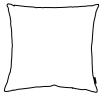





## CUSHIONS

Outer dimensions (l x h x t)

Please store the cushions inside when not in use

		 <b>LUMBAR CUSHION</b> <i>30 x 50 x 17 cm</i>	 <b>DECO CUSHION</b> <i>50 x 50 x 17 cm</i>
	<b>INDIGO</b> Sunbrella® Heritage	<b>€ 75</b> WAL416	<b>€ 100</b> WAL401
	<b>ALPINE</b> Sunbrella® Heritage	<b>€ 75</b> WAL562	<b>€ 100</b> WAL569
	<b>NAMI</b> Sunbrella® Zori	<b>€ 95</b> WAL418	<b>€ 120</b> WAL402
	<b>LOTO</b> Sunbrella® Domino	<b>€ 95</b> WAL403	<b>€ 120</b> WAL419
	<b>RUST</b> Sunbrella® Heritage	<b>€ 75</b> WAL414	<b>€ 100</b> WAL399
	<b>CRAPS</b> Sunbrella® Domino	<b>€ 95</b> WAL404	<b>€ 120</b> WAL420
	<b>BLUSH</b> Sunbrella® Solids	<b>€ 75</b> WAL417	<b>€ 100</b> WAL128
	<b>BISCUIT</b> Sunbrella® Lopi	<b>€ 95</b> WAL564	<b>€ 120</b> WAL563
	<b>COLOR ON REQUEST 1</b> Only for Sunbrella Natté, Solids, Savane & Heritage	<b>€ 100</b> WAL423	<b>€ 125</b> WAL133
	<b>COLOR ON REQUEST 2</b> Only for Sunbrella Chartres	<b>€ 110</b> WAL424	<b>€ 135</b> WAL426
	<b>COLOR ON REQUEST 3</b> Only for Sunbrella Lopi, Domino & Zori	<b>€ 120</b> WAL425	<b>€ 145</b> WAL427

# Gargantua

© design by Dirk Wynants

Gargantua is a large round outdoor picnic table that offers superior functionality. The bench height can be adjusted to suit social or family circumstances. Due to this adjustability, the benches can move when you take a seat. In the highest position the benches become a tabletop extension and provide space for 12 people.



 Check availability  
www.extremis.com/portal

 Wheelchair accessible  
→ p181

 Power options  
→ p44

 ø65 mm







Outer dimensions (ø x h): 231 x 75 cm

		<b>STANDARD</b> Iroko hardwood & Galvanized steel legs	<b>€ 4995</b> GAR001
		<b>FSC 100%</b> Iroko hardwood (FSC 100%) & Galvanized steel legs	<b>€ 5720</b> GAR053

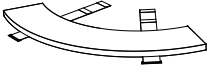
## CUSHIONS

1 set: 4 pieces

Please store the cushions inside when not in use

		<b>GREY CHINÉ</b> Sunbrella® Natté	<b>€ 905/set</b> GAR133
		<b>MARBLE</b> Sunbrella® Lopi	<b>€ 1120/set</b> GAR135
		<b>COLOR ON REQUEST 1</b> Only for Sunbrella Natté, Solids, Savane & Heritage	<b>€ 930/set</b> GAR031
		<b>COLOR ON REQUEST 2</b> Only for Sunbrella Chartres	<b>€ 1040/set</b> GAR137
		<b>COLOR ON REQUEST 3</b> Only for Sunbrella Lopi, Domino & Zori	<b>€ 1145/set</b> GAR138

## BACKRESTS

1 set: 2 pieces

	Galvanized steel	<b>€ 700/set</b> GAR038
---	------------------	----------------------------



### Friends of the product

Inumbra  
medium / large

→ p72



Inumbra  
large

→ p74



## FLOOR FASTENING

Anchoring materials not included

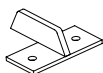

Galvanized steel  
1 set: 4 pieces

**€ 145/set**  
GAR049

## BENCH FASTENING

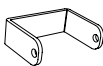

Galvanized steel  
1 set: 4 pieces

**€ 130/set**  
GAR092

## CONNECTION OPTIONS

To combine with Inumbra or Inumbrina



**CONNECTION PIECE INUMBRA**  
Inumbra medium - large

**€ 240**  
INU007



**CONNECTION PIECE INUMBRINA**  
Inumbrina large  
Inner ø5 cm

**€ 185**  
INI010

## GARGANTUA COMBINATION

With Inumbrina large (+ connection piece)



GAR001 + INI010 + INI001

**€ 8060**

## GARGANTUA COMBINATION

With Inumbra large (+ connection piece), cushions (Marble) & backrests



GAR001 + GAR135 + GAR038 (x2)  
+ INU007 + INU004

**€ 11900**

## WIRELESS POWER - OUTDOOR & INDOOR

Outer dimensions (ø): 8 cm

Wireless charger on top, compatible with all devices with wireless charging system

It has a quick charge system | One battery included



2 x USB on battery pack  
Battery 55 wh - Antenna 5w  
IP65 & Shockproof

**€ 395**  
ELE001

## CHARGING TRAY FOR WIRELESS POWER

Outer dimensions (l x w x h): 24 x 8 x 9 cm

Charges up to four stations simultaneously in 7 hours | 4 charging slots

Includes magnetic key to remove the station from its support

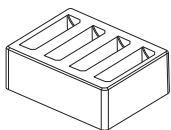

For Europe

**€ 280**  
ELE002

For United Kingdom

**€ 280**  
ELE003



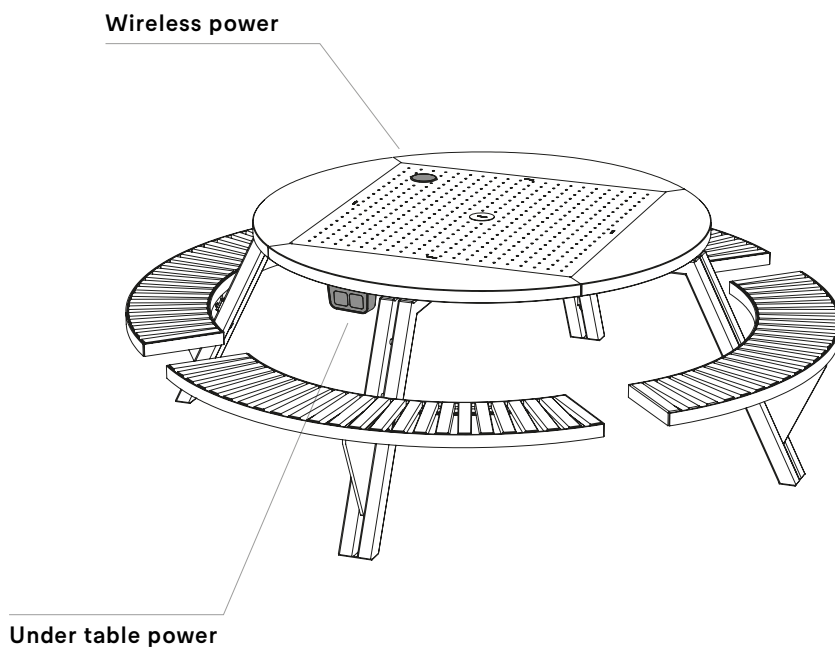

For United States

**€ 280**  
ELE004



## HOW DO I GET THE CORRECT PRODUCT CODE FOR MY POWER MODULE?

Complement the dots with the correct code mentioned below



 <b>SHUKO</b> <i>Europe type F</i>	 <b>UNITED STATES</b> <i>Type B</i>	 <b>UNITED KINGDOM</b> <i>Type G</i>	 <b>SWITZERLAND</b> <i>Type J</i>
.....SO	.....US	.....UK	.....CH

## UNDER TABLE POWER - INDOOR USE ONLY

Outer dimensions (l x w x h): 14 x 8 x 8 cm

Caution, no plug is supplied with the 3-meter cable as there are different types of plugs and sockets around the globe

To be fixed underneath the tabletop

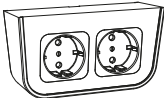
		 <b>WHITE</b>	 <b>BLACK</b>
	<b>2 X SOCKETS</b>	<b>€ 130</b> ELE007...	<b>€ 130</b> ELE009...
	<b>SOCKET + USB</b> USB & USB-C	<b>€ 240</b> ELE006...	<b>€ 240</b> ELE008...

# Hopper bench

© design by Dirk Wynants

In streetscapes and squares, gardens or balconies, Hopper bench suits any location. This multi-functional design can be used in more ways than a traditional city bench. The attached legs allow you to slide in from the sides and sit down with a backrest. And the top surface doubles as a tabletop when facing the opposite direction. The versatility of this design allows for a quick change of scenery while adding comfort along the way. If you prefer a mono-material bench, you can opt for Hopper bench AA, our All Aluminium version.



Check availability  
www.extremis.com/portal



Wheelchair accessible  
→ p179













## HOPPER BENCH 240

Outer dimensions (l x w x h): 238 x 68 x 74 cm - 3 people

Galvanized steel or Structured powder coated aluminium legs | Hellwood = 100% PEFC

The wooden Hopper benches are always with a galvanized steel frame

Always with two anchoring holes ø 1,2 cm

		 <b>AA</b> <i>All aluminium tabletop &amp; bench</i>	 <b>HELLWOOD</b> <i>Thermally treated wood tabletop &amp; bench</i>	 <b>IROKO</b> <i>Tropical hardwood tabletop &amp; bench</i>
	<b>GALVANIZED STEEL</b>	/	<b>€ 2685</b> HOW353	<b>€ 2760</b> HOW357
	<b>BLACK</b> RAL9005	<b>€ 2945</b> HOA382	<b>€ 2945</b> HOW512	<b>€ 3020</b> HOW520
	<b>EARTH</b> RGB 88 88 84	<b>€ 2945</b> HOA377	<b>€ 2945</b> HOW508	<b>€ 3020</b> HOW514
	<b>BEACH BEIGE</b> RAL1019	<b>€ 2945</b> HOA535	<b>€ 2945</b> HOW569	<b>€ 3020</b> HOW566
	<b>OFF WHITE</b> RAL9002	<b>€ 2945</b> HOA534	<b>€ 2945</b> HOW568	<b>€ 3020</b> HOW565
	<b>VERDIGRIS</b> RGB 133 147 142	<b>€ 2945</b> HOA380	<b>€ 2945</b> HOW510	<b>€ 3020</b> HOW518
	<b>REED GREEN</b> RAL6013	<b>€ 2945</b> HOA379	<b>€ 2945</b> HOW513	<b>€ 3020</b> HOW517
	<b>COPPER BROWN</b> RAL8004	<b>€ 2945</b> HOA536	<b>€ 2945</b> HOW570	<b>€ 3020</b> HOW567
	<b>COLOR ON REQUEST</b> Only RAL colors Startup fee € 300 (ex. VAT)	<b>€ 3105</b> HOA378	<b>€ 3105</b> HOW354	<b>€ 3180</b> HOW358



## HOPPER BENCH 300

Outer dimensions (l x w x h): 298 x 68 x 74 cm - 4 people

Galvanized steel or Structured powder coated aluminium legs | Hellwood = 100% PEFC

The wooden Hopper benches are always with a galvanized steel frame

Always with two anchoring holes ø 1,2 cm

<b>AA</b>	<b>HELLWOOD</b>	<b>IROKO</b>		
<i>All aluminium tabletop &amp; bench</i>	<i>Thermally treated wood tabletop &amp; bench</i>	<i>Tropical hardwood tabletop &amp; bench</i>		
	<b>GALVANIZED STEEL</b>	/	<b>€ 3110</b> HOW355	<b>€ 3205</b> HOW359
	<b>BLACK</b> RAL9005	<b>€ 3370</b> HOA388	<b>€ 3370</b> HOW525	<b>€ 3465</b> HOW531
	<b>EARTH</b> RGB 88 88 84	<b>€ 3370</b> HOA383	<b>€ 3370</b> HOW521	<b>€ 3465</b> HOW532
	<b>BEACH BEIGE</b> RAL1019	<b>€ 3370</b> HOA548	<b>€ 3370</b> HOW575	<b>€ 3465</b> HOW572
	<b>OFF WHITE</b> RAL9002	<b>€ 3370</b> HOA547	<b>€ 3370</b> HOW574	<b>€ 3465</b> HOW571
	<b>VERDIGRIS</b> RGB 133 147 142	<b>€ 3370</b> HOA386	<b>€ 3370</b> HOW523	<b>€ 3465</b> HOW529
	<b>REED GREEN</b> RAL6013	<b>€ 3370</b> HOA385	<b>€ 3370</b> HOW526	<b>€ 3465</b> HOW528
	<b>COPPER BROWN</b> RAL8004	<b>€ 3370</b> HOA549	<b>€ 3370</b> HOW576	<b>€ 3465</b> HOW573
	<b>COLOR ON REQUEST</b> Only RAL colors Startup fee € 300 (ex. VAT)	<b>€ 3530</b> HOA384	<b>€ 3530</b> HOW356	<b>€ 3625</b> HOW360









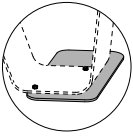

## STABILIZING SUPPORT

Outer dimensions (l x w x h): 52 x 26 x 0,8 cm

Galvanized steel or Structured powder coated zinc steel base plates

Not necessary when anchored to the floor

1 set: 2 pieces

		<b>GALVANIZED STEEL</b>	<b>€ 235/set</b> HOP105
		<b>BLACK</b> RAL9005	<b>€ 385/set</b> HOA371
		<b>EARTH</b> RGB 88 88 84	<b>€ 385/set</b> HOA372
		<b>BEACH BEIGE</b> RAL1019	<b>€ 385/set</b> HOA551
		<b>OFF WHITE</b> RAL9002	<b>€ 385/set</b> HOA550
		<b>VERDIGRIS</b> RGB 133 147 142	<b>€ 385/set</b> HOA373
		<b>REED GREEN</b> RAL6013	<b>€ 385/set</b> HOA374
		<b>COPPER BROWN</b> RAL8004	<b>€ 385/set</b> HOA552
		<b>COLOR ON REQUEST</b> Only RAL colors Startup fee € 300 (ex. VAT)	<b>€ 405/set</b> HOA376



## HOPPER BENCH APPLICATIONS

Where to place the Hopper bench?

Against a wall or balustrade

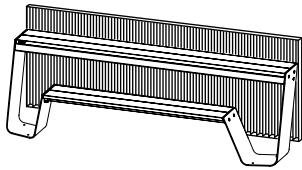

Freestanding, always anchored to the floor

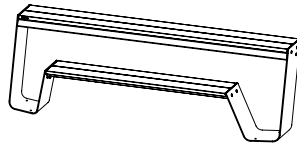

Freestanding with stabilizing support

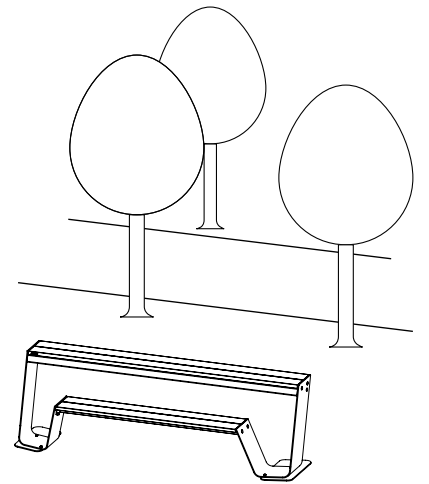



# Hopper combo 180

© design by Dirk Wynants

The Hopper combo combines the best of two worlds: a bench on one side and chairs on the other. Grab a few Captain's Chairs to add comfort. The attached benches allow you to slide in from the sides, without having to lift your legs. The open side offers flexibility and welcomes wheelchairs or child seats at any time.



 Check availability  
www.extremis.com/portal











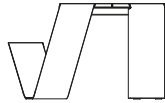

 Wheelchair accessible  
→ p179

 Power options  
→ p68

 Cushions → p62  
Backrest → p64

## STANDARD LEGS

Outer dimensions (l x w x h): 178 x 123 x 74 cm - 4 people | Possible to fit 2 Captain's Chairs  
Structured powder coated aluminium legs | Hellwood = 100% PEFC  
Supported by a galvanized steel frame

	  <b>HELLWOOD</b> <i>Thermally treated wood tabletop &amp; bench</i>	 <b>IROKO</b> <i>Tropical hardwood tabletop &amp; bench</i>	
	<b>BLACK</b> RAL9005	<b>€ 4550</b> HOW129	<b>€ 4640</b> HOW157
	<b>EARTH</b> RGB 88 88 84	<b>€ 4550</b> HOW131	<b>€ 4640</b> HOW159
	<b>BEACH BEIGE</b> RAL1019	<b>€ 4550</b> HOW581	<b>€ 4640</b> HOW578
	<b>OFF WHITE</b> RAL9002	<b>€ 4550</b> HOW580	<b>€ 4640</b> HOW577
	<b>VERDIGRIS</b> RGB 133 147 142	<b>€ 4550</b> HOW134	<b>€ 4640</b> HOW162
	<b>REED GREEN</b> RAL6013	<b>€ 4550</b> HOW133	<b>€ 4640</b> HOW161
	<b>COPPER BROWN</b> RAL8004	<b>€ 4550</b> HOW582	<b>€ 4640</b> HOW579
	<b>COLOR ON REQUEST</b> Only RAL colors Startup fee € 300 (ex. VAT)	<b>€ 4660</b> HOW135	<b>€ 4750</b> HOW163



## Friends of the product

Captain's Chairs



→ p36

Sensu



→ p120

# Hopper combo 240

© design by Dirk Wynants

The Hopper combo combines the best of two worlds: a bench on one side and chairs on the other. Grab a few Captain's Chairs to add comfort. The attached benches allow you to slide in from the sides, without having to lift your legs. The open side offers flexibility and welcomes wheelchairs or child seats at any time. If you prefer a mono-material table, you can opt for Hopper AA, our All Aluminium version.



Check availability  
www.extremis.com/portal



Wheelchair accessible  
→ p179



Power options  
→ p68













Cushions → p62  
Backrest → p65

## STANDARD LEGS

Outer dimensions (l x w x h): 238 x 123 x 74 cm - 6 people | Possible to fit 3 Captain's Chairs

Structured powder coated aluminium legs | Hellwood = 100% PEFC

The wooden Hopper combo has a galvanized steel frame

		 <b>AA</b> <i>All aluminium tabletop &amp; bench</i>	 <b>HELLWOOD</b> <i>Thermally treated wood tabletop &amp; bench</i>	 <b>IROKO</b> <i>Tropical hardwood tabletop &amp; bench</i>
	<b>BLACK</b> RAL9005	€ 5250 HOA356	€ 5250 HOW136	€ 5370 HOW164
	<b>EARTH</b> RGB 88 88 84	€ 5250 HOA357	€ 5250 HOW138	€ 5370 HOW166
	<b>BEACH BEIGE</b> RAL1019	€ 5250 HOA568	€ 5250 HOW587	€ 5370 HOW584
	<b>OFF WHITE</b> RAL9002	€ 5250 HOA567	€ 5250 HOW586	€ 5370 HOW583
	<b>VERDIGRIS</b> RGB 133 147 142	€ 5250 HOA358	€ 5250 HOW141	€ 5370 HOW169
	<b>REED GREEN</b> RAL6013	€ 5250 HOA359	€ 5250 HOW140	€ 5370 HOW168
	<b>COPPER BROWN</b> RAL8004	€ 5250 HOA569	€ 5250 HOW588	€ 5370 HOW585
	<b>COLOR ON REQUEST</b> Only RAL colors Startup fee € 300 (ex. VAT)	€ 5395 HOA360	€ 5360 HOW142	€ 5480 HOW170



## Friends of the product

Captain's Chairs

→ p36



Sensu

→ p120





# Hopper combo 300

© design by Dirk Wynants

The Hopper combo combines the best of two worlds: a bench on one side and chairs on the other. Grab a few Captain's Chairs to add comfort. The attached benches allow you to slide in from the sides, without having to lift your legs. The open side offers flexibility and welcomes wheelchairs or child seats at any time. If you prefer a mono-material table, you can opt for Hopper AA, our All Aluminium version.



 Check availability  
www.extremis.com/portal

 Wheelchair accessible  
→ p179

 Power options  
→ p68











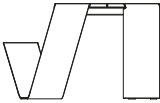

 Cushions → p62  
Backrest → p66

## STANDARD LEGS

Outer dimensions (l x w x h): 298 x 123 x 74 cm - 8 people | Possible to fit 4 Captain's Chairs

Structured powder coated aluminium legs | Hellwood = 100% PEFC

The wooden Hopper combo has a galvanized steel frame

	 <b>AA</b> <i>All aluminium tabletop &amp; bench</i>	 <b>HELLWOOD</b> <i>Thermally treated wood tabletop &amp; bench</i>	 <b>IROKO</b> <i>Tropical hardwood tabletop &amp; bench</i>
	<b>BLACK</b> RAL9005 € 5990 HOA362	<b>€ 5990</b> HOW143	<b>€ 6135</b> HOW171
	<b>EARTH</b> RGB 88 88 84 € 5990 HOA363	<b>€ 5990</b> HOW145	<b>€ 6135</b> HOW173
	<b>BEACH BEIGE</b> RAL1019 € 5990 HOA578	<b>€ 5990</b> HOW593	<b>€ 6135</b> HOW590
	<b>OFF WHITE</b> RAL9002 € 5990 HOA577	<b>€ 5990</b> HOW592	<b>€ 6135</b> HOW589
	<b>VERDIGRIS</b> RGB 133 147 142 € 5990 HOA316	<b>€ 5990</b> HOW148	<b>€ 6135</b> HOW176
	<b>REED GREEN</b> RAL6013 € 5990 HOA314	<b>€ 5990</b> HOW147	<b>€ 6135</b> HOW175
	<b>COPPER BROWN</b> RAL8004 € 5990 HOA579	<b>€ 5990</b> HOW594	<b>€ 6135</b> HOW591
	<b>COLOR ON REQUEST</b> Only RAL colors Startup fee € 300 (ex. VAT) € 6285 HOA364	<b>€ 6100</b> HOW149	<b>€ 6245</b> HOW177



## Friends of the product

Captain's Chairs



→ p36

Sensu



→ p120

# Hopper combo 360

© design by Dirk Wynants



The Hopper combo combines the best of two worlds: a bench on one side and chairs on the other. Grab a few Captain's Chairs to add comfort. The attached benches allow you to slide in from the sides, without having to lift your legs. The open side offers flexibility and welcomes wheelchairs or child seats at any time. If you prefer a mono-material table, you can opt for Hopper AA, our All Aluminium version.



Check availability  
www.extremis.com/portal



Wheelchair accessible  
→ p179



Power options  
→ p68













Cushions → p62  
Backrest → p67

## STANDARD LEGS

Outer dimensions (l x w x h): 358 x 123 x 74 cm - 10 people | Possible to fit 5 Captain's Chairs

Structured powder coated aluminium legs | Hellwood = 100% PEFC

The wooden Hopper combo has a galvanized steel frame

		 <b>AA</b> <i>All aluminium tabletop &amp; bench</i>	 <b>HELLWOOD</b> <i>Thermally treated wood tabletop &amp; bench</i>	 <b>IROKO</b> <i>Tropical hardwood tabletop &amp; bench</i>
	<b>BLACK</b> RAL9005	€ 6780 HOA366	€ 6780 HOW150	€ 6960 HOW178
	<b>EARTH</b> RGB 88 88 84	€ 6780 HOA367	€ 6780 HOW152	€ 6960 HOW180
	<b>BEACH BEIGE</b> RAL1019	€ 6780 HOA592	€ 6780 HOW599	€ 6960 HOW596
	<b>OFF WHITE</b> RAL9002	€ 6780 HOA591	€ 6780 HOW598	€ 6960 HOW595
	<b>VERDIGRIS</b> RGB 133 147 142	€ 6780 HOA368	€ 6780 HOW155	€ 6960 HOW183
	<b>REED GREEN</b> RAL6013	€ 6780 HOA369	€ 6780 HOW154	€ 6960 HOW182
	<b>COPPER BROWN</b> RAL8004	€ 6780 HOA593	€ 6780 HOW600	€ 6960 HOW597
	<b>COLOR ON REQUEST</b> Only RAL colors Startup fee € 300 (ex. VAT)	€ 7115 HOA370	€ 6890 HOW156	€ 7070 HOW184



## Friends of the product

Captain's Chairs

→ p36



Sensu

→ p120



# Hopper picnic 180

© design by Dirk Wynants

Hopper is a more functional solution for a classic concept: the picnic table. The bent leg feature eliminates the awkward straddle of climbing over the benches. Aluminium or steel legs in combination with class I hardwoods ensure material longevity while the attached benches offer a clean aesthetic at all times.



Check availability  
www.extremis.com/portal



Power options  
→ p68



Legs options → p55  
Cushions → p62  
Backrest → p64

## STANDARD LEGS

Outer dimensions (l x w x h): 178 x 160 x 74 cm - 4 people

Galvanized steel or Structured powder coated aluminium legs | Hellwood = 100% PEFC

Supported by a galvanized steel frame

<b>HELLWOOD</b>	<b>IROKO</b>		
<i>Thermally treated wood tabletop &amp; benches</i>	<i>Tropical hardwood tabletop &amp; benches</i>		
	<b>GALVANIZED STEEL</b> Legs	<b>€ 4625</b> HOW004	<b>€ 4735</b> HOW036
	<b>GALVANIZED STEEL WITH ANCHORING HOLES</b> 2 holes per leg: ø 1,2 cm	<b>€ 4730</b> HOW005	<b>€ 4840</b> HOW037
	<b>BLACK</b> RAL9005	<b>€ 5200</b> HOW001	<b>€ 5310</b> HOW033
	<b>EARTH</b> RGB 88 88 84	<b>€ 5200</b> HOW003	<b>€ 5310</b> HOW035
	<b>BEACH BEIGE</b> RAL1019	<b>€ 5200</b> HOW605	<b>€ 5310</b> HOW602
	<b>OFF WHITE</b> RAL9002	<b>€ 5200</b> HOW604	<b>€ 5310</b> HOW601
	<b>VERDIGRIS</b> RGB 133 147 142	<b>€ 5200</b> HOW007	<b>€ 5310</b> HOW039
	<b>REED GREEN</b> RAL6013	<b>€ 5200</b> HOW006	<b>€ 5310</b> HOW038
	<b>COPPER BROWN</b> RAL8004	<b>€ 5200</b> HOW606	<b>€ 5310</b> HOW603
	<b>COLOR ON REQUEST</b> Only RAL colors Startup fee € 300 (ex. VAT)	<b>€ 5320</b> HOW015	<b>€ 5430</b> HOW040

## FLOOR FASTENING SET

Anchoring materials not included

Can not be combined with galvanized steel legs with anchoring holes

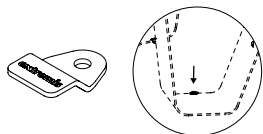

Stainless steel  
1 set: 4 pieces

**€ 135/set**  
HOP021

## PROTECTION FELT

For indoor use

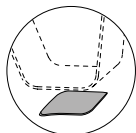

Anthracite felt  
1 set: 4 pieces

**€ 45/set**  
HOP022

# Hopper picnic 240

© design by Dirk Wynants

Hopper is a more functional solution for a classic concept: the picnic table. The bent leg feature eliminates the awkward straddle of climbing over the benches. Aluminium or steel legs in combination with class I hardwoods ensure material longevity while the attached benches offer a clean aesthetic at all times. If you prefer a mono-material picnic table, you can opt for Hopper AA, our All Aluminium version.



 Check availability  
www.extremis.com/portal

 Power options  
→ p68











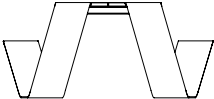



 Legs options → p55  
Cushions → p62  
Backrest → p65

## STANDARD LEGS

Outer dimensions (l x w x h): 238 x 160 x 74 cm - 6 people

Galvanized steel or Structured powder coated aluminium legs | Hellwood = 100% PEFC

The wooden Hopper picnic has a galvanized steel frame

	 <b>AA</b> All aluminium tabletop & benches	 <b>HELLWOOD</b> Thermally treated wood tabletop & benches	 <b>IROKO</b> Tropical hardwood tabletop & benches	
	<b>GALVANIZED STEEL</b>	/	<b>€ 5485</b> HOW011	<b>€ 5625</b> HOW044
	<b>GALVANIZED STEEL WITH ANCHORING HOLES</b> 2 holes per leg: ø 1,2 cm	/	<b>€ 5590</b> HOW012	<b>€ 5730</b> HOW045
	<b>BLACK</b> RAL9005	<b>€ 6060</b> HOA004	<b>€ 6060</b> HOW008	<b>€ 6200</b> HOW041
	<b>EARTH</b> RGB 88 88 84	<b>€ 6060</b> HOA002	<b>€ 6060</b> HOW010	<b>€ 6200</b> HOW043
	<b>BEACH BEIGE</b> RAL1019	<b>€ 6060</b> HOA597	<b>€ 6060</b> HOW611	<b>€ 6200</b> HOW607
	<b>OFF WHITE</b> RAL9002	<b>€ 6060</b> HOA596	<b>€ 6060</b> HOW610	<b>€ 6200</b> HOW608
	<b>VERDIGRIS</b> RGB 133 147 142	<b>€ 6060</b> HOA001	<b>€ 6060</b> HOW014	<b>€ 6200</b> HOW047
	<b>REED GREEN</b> RAL6013	<b>€ 6060</b> HOA005	<b>€ 6060</b> HOW013	<b>€ 6200</b> HOW046
	<b>COPPER BROWN</b> RAL8004	<b>€ 6060</b> HOA297	<b>€ 6060</b> HOW612	<b>€ 6200</b> HOW609
	<b>COLOR ON REQUEST</b> Only RAL colors Startup fee € 300 (ex. VAT)	<b>€ 6240</b> HOA006	<b>€ 6180</b> HOW016	<b>€ 6320</b> HOW048













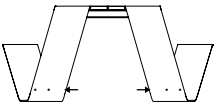



## LEGS WITH PARASOL HOLES

Outer dimensions (l x w x h): 238 x 160 x 74 cm - 6 people

Galvanized steel or Structured powder coated aluminium legs | Hellwood = 100% PEFC

The wooden Hopper picnic has a galvanized steel frame

Should always be combined with the Hopper shade connection option - assembly to Hopper legs (HSH014)

	 <p><b>AA</b> All aluminium tabletop &amp; benches</p>	 <p><b>HELLWOOD</b> Thermally treated wood tabletop &amp; benches</p>	 <p><b>IROKO</b> Tropical hardwood tabletop &amp; benches</p>
 <p><b>GALVANIZED STEEL</b></p>	/	<p><b>€ 5485</b> HOW076</p>	<p><b>€ 5625</b> HOW108</p>
 <p><b>GALVANIZED STEEL WITH ANCHORING HOLES</b> 2 holes per leg: ø 1,2 cm</p>	/	<p><b>€ 5730</b> HOW077</p>	<p><b>€ 5870</b> HOW109</p>
 <p><b>BLACK</b> RAL9005</p>	<p><b>€ 6060</b> HOA022</p>	<p><b>€ 6060</b> HOW073</p>	<p><b>€ 6200</b> HOW105</p>
 <p><b>EARTH</b> RGB 88 88 84</p>	<p><b>€ 6060</b> HOA020</p>	<p><b>€ 6060</b> HOW075</p>	<p><b>€ 6200</b> HOW107</p>
 <p><b>BEACH BEIGE</b> RAL1019</p>	<p><b>€ 6060</b> HOA599</p>	<p><b>€ 6060</b> HOW617</p>	<p><b>€ 6200</b> HOW614</p>
 <p><b>OFF WHITE</b> RAL9002</p>	<p><b>€ 6060</b> HOA598</p>	<p><b>€ 6060</b> HOW616</p>	<p><b>€ 6200</b> HOW613</p>
 <p><b>VERDIGRIS</b> RGB 133 147 142</p>	<p><b>€ 6060</b> HOA019</p>	<p><b>€ 6060</b> HOW079</p>	<p><b>€ 6200</b> HOW111</p>
 <p><b>REED GREEN</b> RAL6013</p>	<p><b>€ 6060</b> HOA023</p>	<p><b>€ 6060</b> HOW078</p>	<p><b>€ 6200</b> HOW110</p>
 <p><b>COPPER BROWN</b> RAL8004</p>	<p><b>€ 6060</b> HOA600</p>	<p><b>€ 6060</b> HOW618</p>	<p><b>€ 6200</b> HOW615</p>
 <p><b>COLOR ON REQUEST</b> Only RAL colors Startup fee € 300 (ex. VAT)</p>	<p><b>€ 6240</b> HOA024</p>	<p><b>€ 6180</b> HOW080</p>	<p><b>€ 6320</b> HOW112</p>



### Friends of the product

Hopper shade

→ p70





# Hopper picnic 300

© design by Dirk Wynants

Hopper is a more functional solution for a classic concept: the picnic table. The bent leg feature eliminates the awkward straddle of climbing over the benches. Aluminium or steel legs in combination with class I hardwoods ensure material longevity while the attached benches offer a clean aesthetic at all times. If you prefer a mono-material picnic table, you can opt for Hopper AA, our All Aluminium version.



 Check availability  
www.extremis.com/portal

 Wheelchair accessible  
→ p183

 Power options  
→ p68











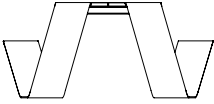



 Legs options → p55  
Cushions → p62  
Backrest → p66

## STANDARD LEGS

Outer dimensions (l x w x h): 298 x 160 x 74 cm - 8 people

Galvanized steel or Structured powder coated aluminium legs | Hellwood = 100% PEFC

The wooden Hopper picnic has a galvanized steel frame

	 <b>AA</b> All aluminium tabletop & benches	 <b>HELLWOOD</b> Thermally treated wood tabletop & benches	 <b>IROKO</b> Tropical hardwood tabletop & benches	
	<b>GALVANIZED STEEL</b>	/	<b>€ 6330</b> HOW020	<b>€ 6500</b> HOW052
	<b>GALVANIZED STEEL WITH ANCHORING HOLES</b> 2 holes per leg: ø 1,2 cm	/	<b>€ 6435</b> HOW021	<b>€ 6605</b> HOW053
	<b>BLACK</b> RAL9005	<b>€ 6905</b> HOA010	<b>€ 6905</b> HOW017	<b>€ 7075</b> HOW049
	<b>EARTH</b> RGB 88 88 84	<b>€ 6905</b> HOA008	<b>€ 6905</b> HOW019	<b>€ 7075</b> HOW051
	<b>BEACH BEIGE</b> RAL1019	<b>€ 6905</b> HOA602	<b>€ 6905</b> HOW622	<b>€ 7075</b> HOW564
	<b>OFF WHITE</b> RAL9002	<b>€ 6905</b> HOA601	<b>€ 6905</b> HOW621	<b>€ 7075</b> HOW619
	<b>VERDIGRIS</b> RGB 133 147 142	<b>€ 6905</b> HOA007	<b>€ 6905</b> HOW023	<b>€ 7075</b> HOW055
	<b>REED GREEN</b> RAL6013	<b>€ 6905</b> HOA011	<b>€ 6905</b> HOW022	<b>€ 7075</b> HOW054
	<b>COPPER BROWN</b> RAL8004	<b>€ 6905</b> HOA513	<b>€ 6905</b> HOW620	<b>€ 7075</b> HOW553
	<b>COLOR ON REQUEST</b> Only RAL colors Startup fee € 300 (ex. VAT)	<b>€ 7240</b> HOA012	<b>€ 7025</b> HOW024	<b>€ 7195</b> HOW056











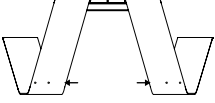



## LEGS WITH PARASOL HOLES

Outer dimensions (l x w x h): 298 x 160 x 74 cm - 8 people

Galvanized steel or Structured powder coated aluminium legs | Hellwood = 100% PEFC

The wooden Hopper picnic has a galvanized steel frame

Should always be combined with the Hopper shade connection option - assembly to Hopper legs (HSH014)

	 <p><b>AA</b> All aluminium tabletop &amp; benches</p>	 <p><b>HELLWOOD</b> Thermally treated wood tabletop &amp; benches</p>	 <p><b>IROKO</b> Tropical hardwood tabletop &amp; benches</p>
 <p><b>GALVANIZED STEEL</b></p>	/	<p>€ 6330 HOW084</p>	<p>€ 6500 HOW116</p>
 <p><b>GALVANIZED STEEL WITH ANCHORING HOLES</b> 2 holes per leg: ø 1,2 cm</p>	/	<p>€ 6575 HOW085</p>	<p>€ 6745 HOW117</p>
 <p><b>BLACK</b> RAL9005</p>	<p>€ 6905 HOA028</p>	<p>€ 6905 HOW081</p>	<p>€ 7075 HOW113</p>
 <p><b>EARTH</b> RGB 88 88 84</p>	<p>€ 6905 HOA026</p>	<p>€ 6905 HOW083</p>	<p>€ 7075 HOW115</p>
 <p><b>BEACH BEIGE</b> RAL1019</p>	<p>€ 6905 HOA606</p>	<p>€ 6905 HOW627</p>	<p>€ 7075 HOW624</p>
 <p><b>OFF WHITE</b> RAL9002</p>	<p>€ 6905 HOA605</p>	<p>€ 6905 HOW626</p>	<p>€ 7075 HOW623</p>
 <p><b>VERDIGRIS</b> RGB 133 147 142</p>	<p>€ 6905 HOA025</p>	<p>€ 6905 HOW087</p>	<p>€ 7075 HOW119</p>
 <p><b>REED GREEN</b> RAL6013</p>	<p>€ 6905 HOA029</p>	<p>€ 6905 HOW086</p>	<p>€ 7075 HOW118</p>
 <p><b>COPPER BROWN</b> RAL8004</p>	<p>€ 6905 HOA607</p>	<p>€ 6905 HOW628</p>	<p>€ 7075 HOW625</p>
 <p><b>COLOR ON REQUEST</b> Only RAL colors Startup fee € 300 (ex. VAT)</p>	<p>€ 7240 HOA030</p>	<p>€ 7025 HOW088</p>	<p>€ 7195 HOW120</p>



### Friends of the product

Hopper shade

→ p70





# Hopper picnic 360

© design by Dirk Wynants

Hopper is a more functional solution for a classic concept: the picnic table. The bent leg feature eliminates the awkward straddle of climbing over the benches. Aluminium or steel legs in combination with class I hardwoods ensure material longevity while the attached benches offer a clean aesthetic at all times. If you prefer a mono-material picnic table, you can opt for Hopper AA, our All Aluminium version.



 Check availability  
www.extremis.com/portal

 Wheelchair accessible  
→ p183

 Power options  
→ p68











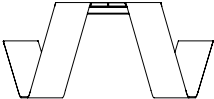



 Legs options → p55  
Cushions → p62  
Backrest → p67

## STANDARD LEGS

Outer dimensions (l x w x h): 358 x 160 x 74 cm - 10 people

Galvanized steel or Structured powder coated aluminium legs | Hellwood = 100% PEFC

The wooden Hopper picnic has a galvanized steel frame

	 <b>AA</b> All aluminium tabletop & benches	 <b>HELLWOOD</b> Thermally treated wood tabletop & benches	 <b>IROKO</b> Tropical hardwood tabletop & benches	
	<b>GALVANIZED STEEL</b>	/	<b>€ 7330</b> HOW028	<b>€ 7550</b> HOW060
	<b>GALVANIZED STEEL WITH ANCHORING HOLES</b> 2 holes per leg: ø 1,2 cm	/	<b>€ 7435</b> HOW029	<b>€ 7655</b> HOW061
	<b>BLACK</b> RAL9005	<b>€ 7905</b> HOA016	<b>€ 7905</b> HOW025	<b>€ 8125</b> HOW057
	<b>EARTH</b> RGB 88 88 84	<b>€ 7905</b> HOA014	<b>€ 7905</b> HOW027	<b>€ 8125</b> HOW059
	<b>BEACH BEIGE</b> RAL1019	<b>€ 7905</b> HOA609	<b>€ 7905</b> HOW633	<b>€ 8125</b> HOW630
	<b>OFF WHITE</b> RAL9002	<b>€ 7905</b> HOA608	<b>€ 7905</b> HOW632	<b>€ 8125</b> HOW629
	<b>VERDIGRIS</b> RGB 133 147 142	<b>€ 7905</b> HOA013	<b>€ 7905</b> HOW031	<b>€ 8125</b> HOW063
	<b>REED GREEN</b> RAL6013	<b>€ 7905</b> HOA017	<b>€ 7905</b> HOW030	<b>€ 8125</b> HOW062
	<b>COPPER BROWN</b> RAL8004	<b>€ 7905</b> HOA610	<b>€ 7905</b> HOW634	<b>€ 8125</b> HOW631
	<b>COLOR ON REQUEST</b> Only RAL colors Startup fee € 300 (ex. VAT)	<b>€ 8295</b> HOA018	<b>€ 8025</b> HOW032	<b>€ 8245</b> HOW064











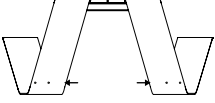



## LEGS WITH PARASOL HOLES

Outer dimensions (l x w x h): 358 x 160 x 74 cm - 10 people

Galvanized steel or Structured powder coated aluminium legs | Hellwood = 100% PEFC

The wooden Hopper picnic has a galvanized steel frame

Should always be combined with the Hopper shade connection option - assembly to Hopper legs (HSH014)

	 <p><b>AA</b> All aluminium tabletop &amp; benches</p>	 <p><b>HELLWOOD</b> Thermally treated wood tabletop &amp; benches</p>	 <p><b>IROKO</b> Tropical hardwood tabletop &amp; benches</p>
 <p><b>GALVANIZED STEEL</b></p>	/	<p><b>€ 7330</b> HOW092</p>	<p><b>€ 7550</b> HOW124</p>
 <p><b>GALVANIZED STEEL WITH ANCHORING HOLES</b> 2 holes per leg: ø 1,2 cm</p>	/	<p><b>€ 7575</b> HOW093</p>	<p><b>€ 7795</b> HOW125</p>
 <p><b>BLACK</b> RAL9005</p>	<p><b>€ 7905</b> HOA034</p>	<p><b>€ 7905</b> HOW089</p>	<p><b>€ 8125</b> HOW121</p>
 <p><b>EARTH</b> RGB 88 88 84</p>	<p><b>€ 7905</b> HOA032</p>	<p><b>€ 7905</b> HOW091</p>	<p><b>€ 8125</b> HOW123</p>
 <p><b>BEACH BEIGE</b> RAL1019</p>	<p><b>€ 7905</b> HOA614</p>	<p><b>€ 7905</b> HOW639</p>	<p><b>€ 8125</b> HOW636</p>
 <p><b>OFF WHITE</b> RAL9002</p>	<p><b>€ 7905</b> HOA613</p>	<p><b>€ 7905</b> HOW638</p>	<p><b>€ 8125</b> HOW635</p>
 <p><b>VERDIGRIS</b> RGB 133 147 142</p>	<p><b>€ 7905</b> HOA031</p>	<p><b>€ 7905</b> HOW095</p>	<p><b>€ 8125</b> HOW127</p>
 <p><b>REED GREEN</b> RAL6013</p>	<p><b>€ 7905</b> HOA035</p>	<p><b>€ 7905</b> HOW094</p>	<p><b>€ 8125</b> HOW126</p>
 <p><b>COPPER BROWN</b> RAL8004</p>	<p><b>€ 7905</b> HOA615</p>	<p><b>€ 7905</b> HOW640</p>	<p><b>€ 8125</b> HOW637</p>
 <p><b>COLOR ON REQUEST</b> Only RAL colors Startup fee € 300 (ex. VAT)</p>	<p><b>€ 8295</b> HOA036</p>	<p><b>€ 8025</b> HOW096</p>	<p><b>€ 8245</b> HOW128</p>



### Friends of the product

Hopper shade

→ p70











## CUSHIONS

Outer dimensions (l x w x t) - 1 piece

You need 1 piece for every bench

Please store the cushions inside when not in use

	<b>180</b> <i>For Hopper 180</i> 97 x 27 x 3 cm	<b>240</b> <i>For Hopper 240</i> 157 x 27 x 3 cm	<b>300</b> <i>For Hopper 300</i> 217 x 27 x 3 cm	<b>360</b> <i>For Hopper 360</i> 277 x 27 x 3 cm	
	<b>GREY CHINÉ</b> Sunbrella® Natté	€ 285 HOP942	€ 345 HOP943	€ 460 HOP658	€ 570 HOP944
	<b>DARK TAUPE</b> Sunbrella® Natté	€ 285 HOP945	€ 345 HOP758	€ 460 HOP643	€ 570 HOP657
	<b>COCONUT</b> Sunbrella® Savane	€ 285 HOP970	€ 345 HOP974	€ 460 HOP941	€ 570 HOP935
	<b>MARBLE</b> Sunbrella® Lopi	€ 325 HOP946	€ 440 HOP928	€ 565 HOP947	€ 670 HOP948
	<b>CHARCOAL</b> Sunbrella® Lopi	€ 325 HOP949	€ 440 HOP950	€ 565 HOP951	€ 670 HOP952
	<b>LEAF GREEN</b> Sunbrella® Heritage	€ 285 HOP953	€ 345 HOP954	€ 460 HOP955	€ 570 HOP956









## CUSHIONS

Outer dimensions (l x w x t) - 1 piece

You need 1 piece for every bench

Please store the cushions inside when not in use













	<b>180</b> <i>For Hopper 180</i> <i>97 x 27 x 3 cm</i>	<b>240</b> <i>For Hopper 240</i> <i>157 x 27 x 3 cm</i>	<b>300</b> <i>For Hopper 300</i> <i>217 x 27 x 3 cm</i>	<b>360</b> <i>For Hopper 360</i> <i>277 x 27 x 3 cm</i>
 <b>RUST</b> Sunbrella® Heritage	<b>€ 285</b> HOP957	<b>€ 345</b> HOP958	<b>€ 460</b> HOP959	<b>€ 570</b> HOP960
 <b>BISCUIT</b> Sunbrella® Lopi	<b>€ 325</b> HOP939	<b>€ 440</b> HOP938	<b>€ 565</b> HOP937	<b>€ 670</b> HOP936
 <b>COLOR ON REQUEST 1</b> Only for Sunbrella Natté, Solids, Savane & Heritage	<b>€ 310</b> HOP961	<b>€ 370</b> HOP964	<b>€ 485</b> HOP967	<b>€ 595</b> HOP971
 <b>COLOR ON REQUEST 2</b> Only for Sunbrella Chartres	<b>€ 330</b> HOP962	<b>€ 415</b> HOP965	<b>€ 540</b> HOP968	<b>€ 645</b> HOP972
 <b>COLOR ON REQUEST 3</b> Only for Sunbrella Lopi, Domino & Zori	<b>€ 350</b> HOP963	<b>€ 465</b> HOP966	<b>€ 590</b> HOP969	<b>€ 695</b> HOP973



**BACKREST FOR HOPPER 180**

105 cm - 1 piece

Galvanized steel or Structured powder coated aluminium backrest supports | Hellwood = 100% PEFC

	  <p><b>HELLWOOD</b> <i>Thermally treated wood Backrest</i></p>	 <p><b>IROKO</b> <i>Tropical hardwood Backrest</i></p>
 <p><b>GALVANIZED STEEL</b></p>	<p><b>€ 505</b> HOW431</p>	<p><b>€ 525</b> HOW424</p>
 <p><b>BLACK</b> RAL9005</p>	<p><b>€ 595</b> HOW432</p>	<p><b>€ 615</b> HOW425</p>
 <p><b>EARTH</b> RGB 88 88 84</p>	<p><b>€ 595</b> HOW433</p>	<p><b>€ 615</b> HOW426</p>
 <p><b>BEACH BEIGE</b> RAL1019</p>	<p><b>€ 595</b> HOW654</p>	<p><b>€ 615</b> HOW651</p>
 <p><b>OFF WHITE</b> RAL9002</p>	<p><b>€ 595</b> HOW653</p>	<p><b>€ 615</b> HOW650</p>
 <p><b>VERDIGRIS</b> RGB 133 147 142</p>	<p><b>€ 595</b> HOW435</p>	<p><b>€ 615</b> HOW428</p>
 <p><b>REED GREEN</b> RAL6013</p>	<p><b>€ 595</b> HOW436</p>	<p><b>€ 615</b> HOW429</p>
 <p><b>COPPER BROWN</b> RAL8004</p>	<p><b>€ 595</b> HOW655</p>	<p><b>€ 615</b> HOW652</p>
 <p><b>COLOR ON REQUEST</b> Only RAL colors Startup fee € 300 (ex. VAT)</p>	<p><b>€ 620</b> HOW437</p>	<p><b>€ 640</b> HOW430</p>











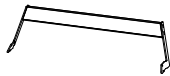





## BACKREST FOR HOPPER 240

165 cm - 1 piece

Galvanized steel or Structured powder coated aluminium backrest supports | Hellwood = 100% PEFC











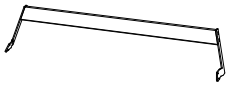



	 <p><b>AA</b> <i>All aluminium Backrest</i></p>	 <p><b>HELLWOOD</b> <i>Thermally treated wood Backrest</i></p>	 <p><b>IROKO</b> <i>Tropical hardwood Backrest</i></p>
 <p><b>GALVANIZED STEEL</b></p>	/	<p><b>€ 535</b> HOW445</p>	<p><b>€ 560</b> HOW438</p>
 <p><b>BLACK</b> RAL9005</p>	<p><b>€ 625</b> HOA318</p>	<p><b>€ 625</b> HOW446</p>	<p><b>€ 650</b> HOW439</p>
 <p><b>EARTH</b> RGB 88 88 84</p>	<p><b>€ 625</b> HOA319</p>	<p><b>€ 625</b> HOW447</p>	<p><b>€ 650</b> HOW440</p>
 <p><b>BEACH BEIGE</b> RAL1019</p>	<p><b>€ 625</b> HOA617</p>	<p><b>€ 625</b> HOW660</p>	<p><b>€ 650</b> HOW657</p>
 <p><b>OFF WHITE</b> RAL9002</p>	<p><b>€ 625</b> HOA616</p>	<p><b>€ 625</b> HOW659</p>	<p><b>€ 650</b> HOW656</p>
 <p><b>VERDIGRIS</b> RGB 133 147 142</p>	<p><b>€ 625</b> HOA320</p>	<p><b>€ 625</b> HOW449</p>	<p><b>€ 650</b> HOW442</p>
 <p><b>REED GREEN</b> RAL6013</p>	<p><b>€ 625</b> HOA321</p>	<p><b>€ 625</b> HOW450</p>	<p><b>€ 650</b> HOW443</p>
 <p><b>COPPER BROWN</b> RAL8004</p>	<p><b>€ 625</b> HOA618</p>	<p><b>€ 625</b> HOW661</p>	<p><b>€ 650</b> HOW658</p>
 <p><b>COLOR ON REQUEST</b> Only RAL colors Startup fee € 300 (ex. VAT)</p>	<p><b>€ 655</b> HOA323</p>	<p><b>€ 650</b> HOW451</p>	<p><b>€ 675</b> HOW444</p>



## BACKREST FOR HOPPER 300

225 cm - 1 piece

Galvanized steel or Structured powder coated aluminium backrest supports | Hellwood = 100% PEFC











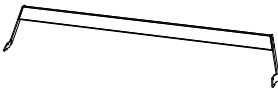

	 <p><b>AA</b> All aluminium Backrest</p>	  <p><b>HELLWOOD</b> Thermally treated wood Backrest</p>	 <p><b>IROKO</b> Tropical hardwood Backrest</p>
 <p><b>GALVANIZED STEEL</b></p>	/	<p><b>€ 600</b> HOW459</p>	<p><b>€ 625</b> HOW452</p>
 <p><b>BLACK</b> RAL9005</p>	<p><b>€ 690</b> HOA325</p>	<p><b>€ 690</b> HOW460</p>	<p><b>€ 715</b> HOW453</p>
 <p><b>EARTH</b> RGB 88 88 84</p>	<p><b>€ 690</b> HOA326</p>	<p><b>€ 690</b> HOW461</p>	<p><b>€ 715</b> HOW454</p>
 <p><b>BEACH BEIGE</b> RAL1019</p>	<p><b>€ 690</b> HOA620</p>	<p><b>€ 690</b> HOW672</p>	<p><b>€ 715</b> HOW669</p>
 <p><b>OFF WHITE</b> RAL9002</p>	<p><b>€ 690</b> HOA619</p>	<p><b>€ 690</b> HOW671</p>	<p><b>€ 715</b> HOW668</p>
 <p><b>VERDIGRIS</b> RGB 133 147 142</p>	<p><b>€ 690</b> HOA327</p>	<p><b>€ 690</b> HOW480</p>	<p><b>€ 715</b> HOW456</p>
 <p><b>REED GREEN</b> RAL6013</p>	<p><b>€ 690</b> HOA328</p>	<p><b>€ 690</b> HOW463</p>	<p><b>€ 715</b> HOW457</p>
 <p><b>COPPER BROWN</b> RAL8004</p>	<p><b>€ 690</b> HOA621</p>	<p><b>€ 690</b> HOW673</p>	<p><b>€ 715</b> HOW670</p>
 <p><b>COLOR ON REQUEST</b> Only RAL colors Startup fee € 300 (ex. VAT)</p>	<p><b>€ 725</b> HOA330</p>	<p><b>€ 715</b> HOW464</p>	<p><b>€ 740</b> HOW458</p>



## BACKREST FOR HOPPER 360

285 cm - 1 piece

Galvanized steel or Structured powder coated aluminium backrest supports | Hellwood = 100% PEFC

	 <p><b>AA</b> <i>All aluminium Backrest</i></p>	 <p><b>HELLWOOD</b> <i>Thermally treated wood Backrest</i></p>	 <p><b>IROKO</b> <i>Tropical hardwood Backrest</i></p>
 <p><b>GALVANIZED STEEL</b></p>	/	<p><b>€ 770</b> HOW472</p>	<p><b>€ 820</b> HOW465</p>
 <p><b>BLACK</b> RAL9005</p>	<p><b>€ 860</b> HOA331</p>	<p><b>€ 860</b> HOW473</p>	<p><b>€ 910</b> HOW466</p>
 <p><b>EARTH</b> RGB 88 88 84</p>	<p><b>€ 860</b> HOA332</p>	<p><b>€ 860</b> HOW474</p>	<p><b>€ 910</b> HOW467</p>
 <p><b>BEACH BEIGE</b> RAL1019</p>	<p><b>€ 860</b> HOA623</p>	<p><b>€ 860</b> HOW666</p>	<p><b>€ 910</b> HOW663</p>
 <p><b>OFF WHITE</b> RAL9002</p>	<p><b>€ 860</b> HOA622</p>	<p><b>€ 860</b> HOW665</p>	<p><b>€ 910</b> HOW662</p>
 <p><b>VERDIGRIS</b> RGB 133 147 142</p>	<p><b>€ 860</b> HOA333</p>	<p><b>€ 860</b> HOW481</p>	<p><b>€ 910</b> HOW469</p>
 <p><b>REED GREEN</b> RAL6013</p>	<p><b>€ 860</b> HOA334</p>	<p><b>€ 860</b> HOW476</p>	<p><b>€ 910</b> HOW470</p>
 <p><b>COPPER BROWN</b> RAL8004</p>	<p><b>€ 860</b> HOA624</p>	<p><b>€ 860</b> HOW667</p>	<p><b>€ 910</b> HOW664</p>
 <p><b>COLOR ON REQUEST</b> Only RAL colors Startup fee € 300 (ex. VAT)</p>	<p><b>€ 905</b> HOA336</p>	<p><b>€ 885</b> HOW477</p>	<p><b>€ 935</b> HOW471</p>

## WIRELESS POWER - OUTDOOR & INDOOR

Outer dimensions (ø): 8 cm

Wireless charger on top, compatible with all devices with wireless charging system

It has a quick charge system | One battery included

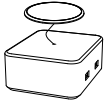

2 x USB on battery pack  
Battery 55 wh - Antenna 5w  
IP65 & Shockproof

**€ 395**  
ELE001

## CHARGING TRAY FOR WIRELESS POWER

Outer dimensions (l x w x h): 24 x 8 x 9 cm

Charges up to four stations simultaneously in 7 hours | 4 charging slots

Includes magnetic key to remove the station from its support

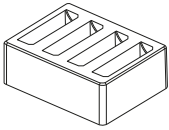

For Europe

**€ 280**  
ELE002

For United Kingdom

**€ 280**  
ELE003

For United States

**€ 280**  
ELE004



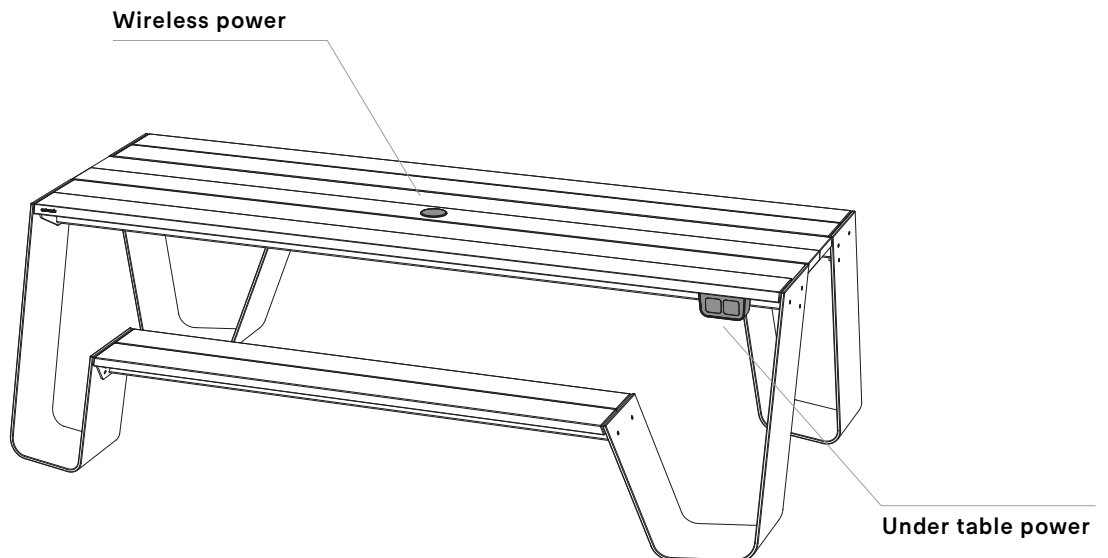

## HOPPER

With power options



## HOW DO I GET THE CORRECT PRODUCT CODE FOR MY POWER MODULE?

Complement the dots with the correct code mentioned below



 <b>SHUKO</b> <i>Europe type F</i>	 <b>UNITED STATES</b> <i>Type B</i>	 <b>UNITED KINGDOM</b> <i>Type G</i>	 <b>SWITZERLAND</b> <i>Type J</i>
.....SO	.....US	.....UK	.....CH

## UNDER TABLE POWER - INDOOR USE ONLY

Outer dimensions (l x w x h): 14 x 8 x 8 cm

Caution, no plug is supplied with the 3-meter cable as there are different types of plugs and sockets around the globe

To be fixed underneath the tabletop

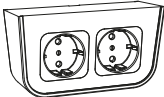
		 <b>WHITE</b>	 <b>BLACK</b>
	<b>2 X SOCKETS</b>	<b>€ 130</b> ELE007...	<b>€ 130</b> ELE009...
	<b>SOCKET + USB</b> USB & USB-C	<b>€ 240</b> ELE006...	<b>€ 240</b> ELE008...

## SQUARE IN-TABLE POWER - INDOOR USE ONLY

Outer dimensions (l x w): 19 x 8 cm

Caution, no plug is supplied with the 3-meter cable as there are different types of plugs and sockets around the globe

Cut-out in tabletop included

		<b>3 X SOCKET</b> Black	<b>€ 310</b> ELE010...
		<b>2 X SOCKET + USB</b> Black USB & USB-C	<b>€ 420</b> ELE011...

## HOPPER AA

With power options

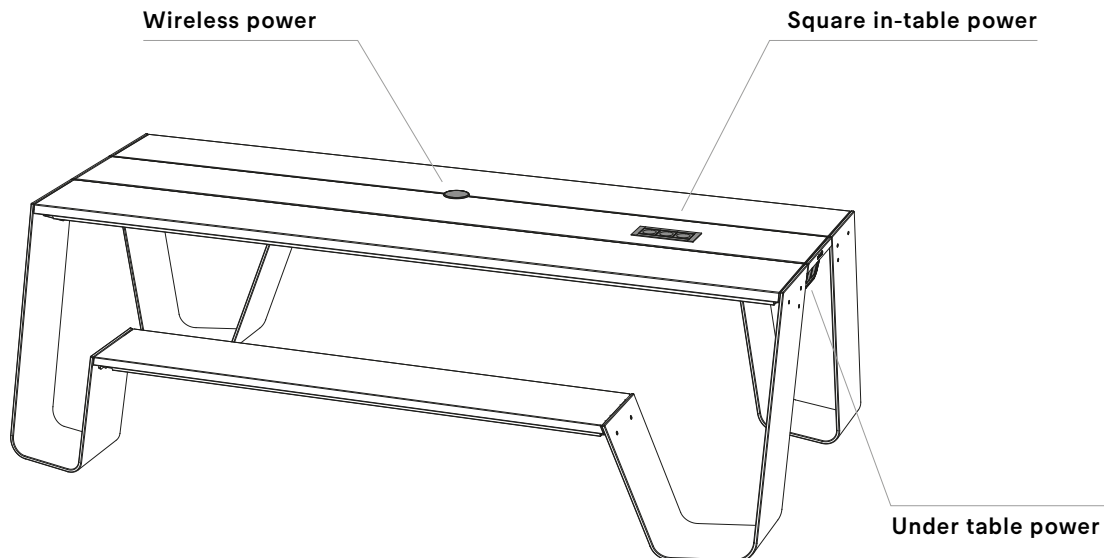

# Hopper shade

© design by Dirk Wynants

In the opened and closed positions, Hopper shade echoes the lines of the Hopper design. It opens and closes effortlessly, thanks to an internal spring mechanism that takes up no extra space beside the table. This foldable canopy creates ample shade for everyone in a simple, aesthetically pleasing way.







Check availability  
[www.extremis.com/portal](http://www.extremis.com/portal)

Outer dimensions (l x w x h)

High-tech polyester fabric + Stainless steel poles AISI 316

Always combine with one of the connection options on the next page

Cover included

		 <b>WHITE</b> <i>Fabric</i>	 <b>GREY TAUPE</b> <i>Fabric</i>
	<p><b>240</b> 241 x 268 x 211 cm</p>	<p><b>€ 3980</b> HSH007</p>	<p><b>€ 3980</b> HSH008</p>
	<p><b>300</b> 301 x 268 x 211 cm</p>	<p><b>€ 4170</b> HSH009</p>	<p><b>€ 4170</b> HSH010</p>
	<p><b>360</b> 361 x 268 x 211 cm</p>	<p><b>€ 4515</b> HSH011</p>	<p><b>€ 4515</b> HSH012</p>



## Friends of the product

Hopper  
picnic

→ p54



Hopper  
picnic AA

→ p56



### ASSEMBLY UNDER HOPPER PICNIC

(fig. 1)

You need 1 set for every Hopper shade

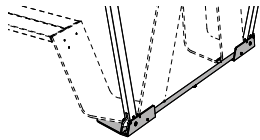

Only to combine with Hopper picnic 240/300/360  
Can not be combined with galvanized steel legs with  
anchoring holes

**€ 1240/set**  
HSH013

### ASSEMBLY TO HOPPER LEGS

(fig. 2)

You need 1 set for every Hopper shade

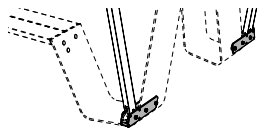

Attach to Hopper picnic legs (with holes)  
Only to combine with Hopper picnic 240/300/360  
Not possible to add afterwards

**€ 790/set**  
HSH014

### FLOOR FASTENING

(fig. 3)

You need 1 set for every Hopper shade

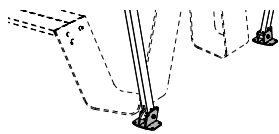

Combine with any table  
Anchoring materials not included

**€ 580/set**  
HSH015

### CONCRETE BASE

(fig. 4)

You need 1 set for every Hopper shade - 120 kg

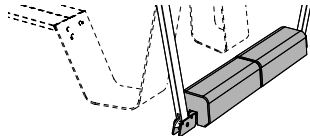

Combine with any table  
In combination with Hopper choose the shade 1 size  
larger, otherwise the table won't fit

**€ 1215/set**  
HSH016

(fig. 1)

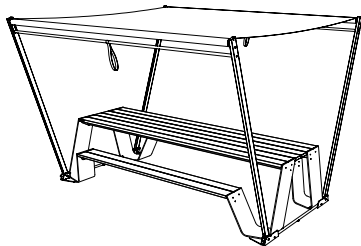

(fig. 2)

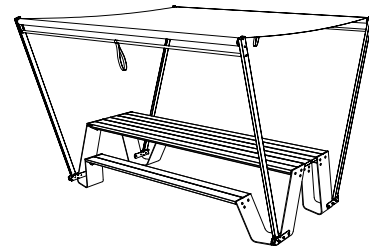

(fig. 3)

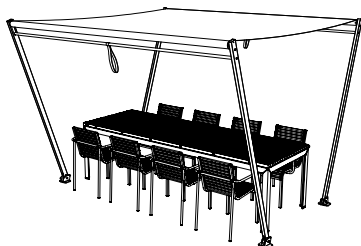

(fig. 4)

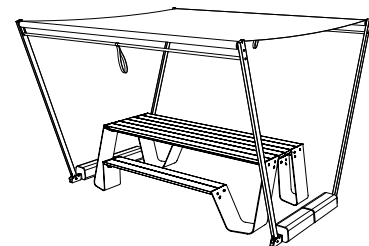

# Inumbra

© design by Dirk Wynants

Inumbra is unique because of its pure aesthetics. The mechanical parts of this umbrella are positioned at the top, resulting in a flat canopy that catches less wind than typical convex shapes. Tests in a windtunnel have shown that the shade withstands wind speeds up to 8 on the Beaufort scale (74 km/h) when anchored to the floor. Still, we strongly advise to close it sooner (from 6 on the Beaufort scale (49 km/h)). When paired with Gargantua or Pantagruel picnic, the umbrella pole is fastened to the tabletop. This looks clean and is also practical, as no legroom is lost under the table. The combination makes it the sturdiest terrace set you have ever seen.



Check availability  
www.extremis.com/portal









ø63,5 mm

## INUMBRA MEDIUM

Outer dimensions (ø): 350 cm

High-tech polyester fabric + Stainless steel or Structured powder coated stainless steel pole

Cover included





		 <b>WHITE</b> <i>Fabric</i>	 <b>TAUPE</b> <i>Fabric</i>	 <b>BLACK</b> <i>Fabric</i>
	 <b>STAINLESS STEEL</b>	€ 3890 INU001	€ 3890 INU002	€ 3890 INU003
	 <b>BLACK</b> RAL9005	/	€ 4185 INU268	€ 4185 INU270

## INUMBRA LARGE

Outer dimensions (ø): 400 cm

High-tech polyester fabric + Stainless steel or Structured powder coated stainless steel pole

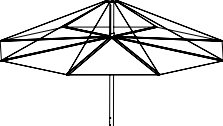
Cover included

		 <b>WHITE</b> <i>Fabric</i>	 <b>TAUPE</b> <i>Fabric</i>	 <b>BLACK</b> <i>Fabric</i>
	 <b>STAINLESS STEEL</b>	€ 4145 INU004	€ 4145 INU005	€ 4145 INU006
	 <b>BLACK</b> RAL9005	/	€ 4450 INU265	€ 4450 INU247



### Friends of the product

Gargantua



→ p42

Pantagruel picnic



→ p108

Pantagruel table



→ p112

Pantagruel high table



→ p114



## CONNECTION PIECE



Stainless steel  
To combine with Gargantua or Pantagruel



€ 240  
INU007

## FLOOR FASTENING

Outer dimensions (ø x h)

Stainless steel or Structured powder coated stainless steel parasol base



Anchoring materials not included

			<b>LOW</b> <i>Parasol base</i> 25 x 60 cm	<b>HIGH</b> <i>Parasol base</i> 25 x 70 cm
		<b>STAINLESS STEEL</b>	€ 665 INU009	€ 690 INU010
		<b>BLACK</b> RAL9005	€ 725 INU280	€ 755 INU285

## CONCRETE BASE

Outer dimensions (l x w x h)

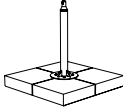

Including stainless steel or structured powder coated stainless steel parasol base

			<b>LOW</b> <i>Parasol base</i> 125 kg - 76 x 76 x 71 cm	<b>HIGH</b> <i>Parasol base</i> 126 kg - 76 x 76 x 81 cm
		<b>STAINLESS STEEL</b>	€ 1085 INU011	€ 1110 INU012
		<b>BLACK</b> RAL9005	€ 1145 INU288	€ 1175 INU290

## CONCRETE WHEEL BASE

Outer dimensions (l x w x h): 82 x 82 x 78 cm - 140 kg

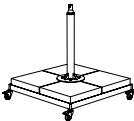
Including stainless steel or structured powder coated stainless steel parasol base

		<b>STAINLESS STEEL</b>	€ 1710 INU013
		<b>BLACK</b> RAL9005	€ 1770 INU292

# Inumbrina

© design by Dirk Wynants

The major difference between Inumbra and Inumbrina lies in how they are operated. Opening and closing the parasol with a rope turns out to be really easy, and even faster! Although the parasol can withstand wind speeds of up to 8 on the Beaufort scale, it is advisable to close it sooner (from wind speed 6 as a rule of thumb).



 Check availability  
www.extremis.com/portal



 ø48 mm (large)  
ø35 mm (medium)

## INUMBRINA LARGE

High-tech polyester fabric + Stainless steel pole | Cover included

		 <b>WHITE</b> <i>Fabric</i>	 <b>TAUPE</b> <i>Fabric</i>	 <b>BLACK</b> <i>Fabric</i>
	<b>LARGE</b> ø 380 cm	<b>€ 2880</b> INI001	<b>€ 2880</b> INI002	<b>€ 2880</b> INI003

## CONNECTION OPTIONS FOR INUMBRINA LARGE

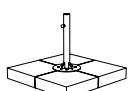
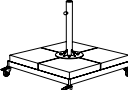
	<b>CONNECTION PIECE</b> Stainless steel To combine with Gargantua or Pantagrue!	<b>€ 185</b> INI010
	<b>FLOOR FASTENING</b> Stainless steel parasol base Anchoring materials not included	<b>€ 425</b> INI011
	<b>CONCRETE BASE</b> Including stainless steel parasol base 125 kg - 76 x 76 x 60 cm	<b>€ 845</b> INI012
	<b>CONCRETE WHEEL BASE</b> Including stainless steel parasol base 140 kg - 82 x 82 x 68 cm	<b>€ 1470</b> INI013



## Friends of the product

Gargantua

→ p42



Pantagrue!  
picnic

→ p108



Pantagrue!  
table

→ p112







## INUMBRINA MEDIUM



High-tech polyester fabric + Stainless steel pole | Cover included



		 <b>WHITE</b> <i>Fabric</i>	 <b>TAUPE</b> <i>Fabric</i>	 <b>BLACK</b> <i>Fabric</i>
	<b>MEDIUM</b> ø320 cm	<b>€ 2410</b> INI007	<b>€ 2410</b> INI008	<b>€ 2410</b> INI009

## CONNECTION OPTIONS FOR INUMBRINA MEDIUM

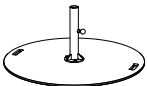
	<b>CONNECTION PIECE</b> Galvanized steel To combine with Anker	<b>€ 115</b> ANK331
---	--	------------------------

	<b>FLOOR FASTENING</b> Stainless steel parasol base Anchoring materials not included	<b>€ 310</b> INI014
---	--	------------------------

 	<b>PARASOL BASE STANDARD</b> Stainless steel parasol base & 1 galvanized steel base plate 27 kg - ø 73 x 29 cm	<b>€ 625</b> INI222
---	---	------------------------

 	<b>PARASOL BASE HEAVY DUTY</b> Stainless steel parasol base & 2 galvanized steel base plates 52 kg - ø 73 x 30 cm	<b>€ 940</b> INI237
---	--	------------------------



## Friends of the product

Anker  
(medium)

→ p28



## INUMBRA COMBINATIONS

Gargantua - Pantagruel - stand alone

Inumbra large +  
connection piece & Gargantua

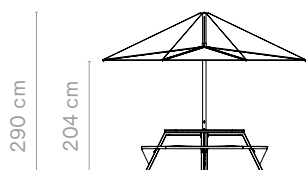

Inumbra large +  
connection piece & Pantagruel picnic

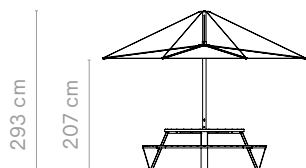

Inumbra large +  
parasol base for floor fastening 60/70

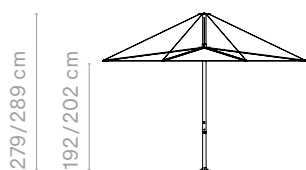

Inumbra large +  
concrete base 71/81

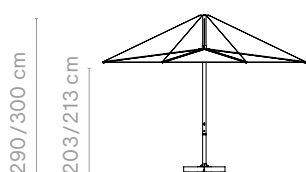

Inumbra large +  
concrete wheel base

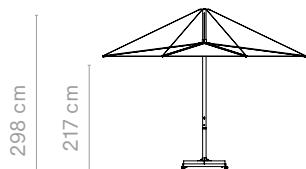

Inumbra medium +  
connection piece & Gargantua

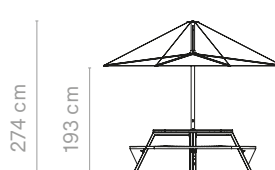

Inumbra medium +  
connection piece & Pantagruel picnic

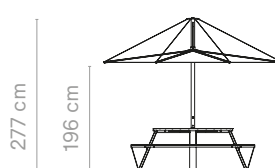

Inumbra medium +  
parasol base for floor fastening 60/70



Inumbra medium +  
concrete base 71/81



Inumbra medium +  
concrete wheel base



## INUMBRINA COMBINATIONS

Gargantua - Pantagruel - Anker - stand alone

Inumbrina large +  
connection piece & Gargantua

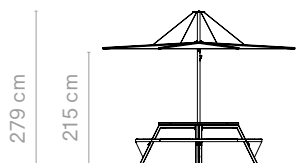

Inumbrina large +  
connection piece & Pantagruel picnic

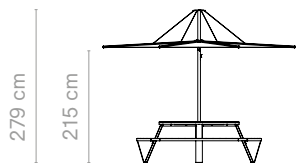

Inumbrina large +  
parasol base for floor fastening

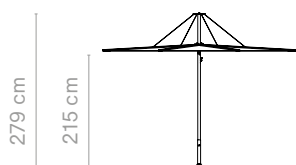

Inumbrina large +  
concrete base

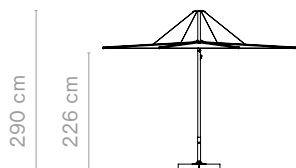

Inumbrina large +  
concrete wheel base



Inumbrina medium +  
Anker

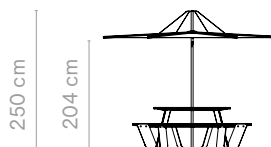

Inumbrina medium +  
parasol base for floor fastening



Inumbrina medium +  
parasol base standard/heavy duty



This table-seat-lounge combination makes efficient use of the space available by combining functionalities such as sofa, meeting spot, dining table and lounge bed. Convert the Kosmos sofa into a lounge bed by setting the adjustable table to its lowest position and adding a cushion.

Combine a base + cushions to compose your favorite Kosmos. Add a deco and lumbar cushion for extra comfort.

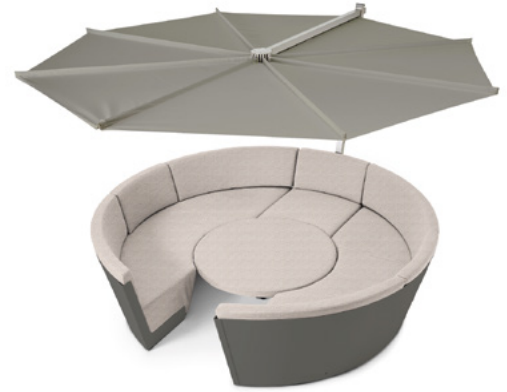

Check availability  
[www.extremis.com/portal](http://www.extremis.com/portal)





## 8-SEATER LOW - BASE | NO PARASOL HOLES

Outer dimensions (ø x h): 260 x 73 cm

Can not be combined with Kosmos shade

Structured powder coated aluminium shell with matching tabletop color | No cushions included

(Color on request - Startup fee € 300 (ex. VAT))

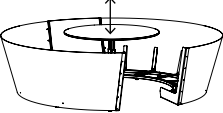
		 <b>BLACK</b> RAL9005	 <b>EARTH</b> RGB 88 88 84	 <b>OFF WHITE</b> RAL9002	 <b>ON REQUEST</b> Only RAL-colors
	<b>SHELL + FIXED TABLE</b>	€ 7585 KOS604	€ 7585 KOS605	€ 7585 KOS805	€ 7965 KOS008
	<b>SHELL + ADJUSTABLE TABLE</b>	€ 8105 KOS422	€ 8105 KOS609	€ 8105 KOS808	€ 8510 KOS006





## 8-SEATER LOW - BASE | PARASOL READY, WITH HOLES

Outer dimensions (ø x h): 260 x 73 cm

The back of the shell had a recess to combine with Kosmos shade

Structured powder coated aluminium shell with matching tabletop color | No cushions included

(Color on request - Startup fee € 300 (ex. VAT))

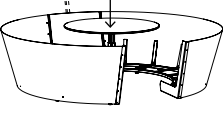
		 <b>BLACK</b> RAL9005	 <b>EARTH</b> RGB 88 88 84	 <b>OFF WHITE</b> RAL9002	 <b>ON REQUEST</b> Only RAL-colors
	<b>SHELL + FIXED TABLE</b>	€ 7550 KOS606	€ 7550 KOS607	€ 7550 KOS810	€ 7925 KOS004
	<b>SHELL + ADJUSTABLE TABLE</b>	€ 8130 KOS610	€ 8130 KOS697	€ 8130 KOS813	€ 8535 KOS002



### Friends of the product

Deco cushions

→ p40







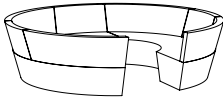

Kosmos shade

→ p82





### 8-SEATER LOW - SUNBRELLA CUSHIONS

		<b>GREY CHINÉ</b> Sunbrella® Natté	<b>€ 5825</b> KOS335
		<b>DARK TAUPE</b> Sunbrella® Natté	<b>€ 5825</b> KOS014
		<b>MARBLE</b> Sunbrella® Lopi	<b>€ 7005</b> KOS627
		<b>COLOR ON REQUEST 1</b> Only for Sunbrella Natté, Solids, Savane & Heritage	<b>€ 6120</b> KOS015
		<b>COLOR ON REQUEST 2</b> Only for Sunbrella Chartres	<b>€ 6755</b> KOS655
		<b>COLOR ON REQUEST 3</b> Only for Sunbrella Lopi, Domino & Zori	<b>€ 7350</b> KOS659

### 8-SEATER LOW - COVER

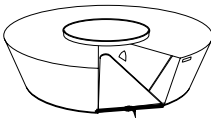
Use a cover if you intend to leave Kosmos outdoors

		<b>WHITE</b> Pvc coated polyester	<b>€ 1135</b> KOS016
---	---	--------------------------------------	-------------------------

### SEATING PLACES

How many people can sit on a Kosmos?

Kosmos 8-seater low

8 to 9 people sitting up straight  
 3 to 4 people lying down

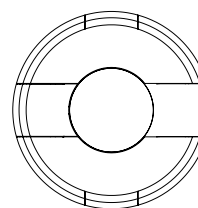

# Kosmos shade

© design by Dirk Wynants

The Kosmos shade has an ingenious design and opens horizontally like a fan. Tests in a windtunnel have shown that the shade withstands wind speeds up to 6 on the Beaufort scale (49 km/h) when anchored to the floor. Still, we strongly advise to close it sooner (from 4 on the Beaufort scale (28 km/h)). This designer shade hangs low enough to provide plenty of shade, and is perfect for placing next to the Kosmos table and seat combination or any other furniture. Two hidden magnets keep the parasol open.





Check availability  
[www.extremis.com/portal](http://www.extremis.com/portal)

## ROUND SHADE

Outer dimensions (ø x h)

High-tech polyester fabric + Stainless steel pole AISI 316 | Cover included

Shade + LED: In countries where this type of plug is not used, a different plug will need to be fitted (cable = 10 meter)

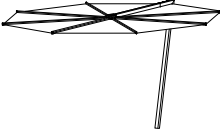
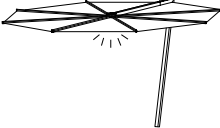
		 <b>WHITE</b> <i>Fabric</i>	 <b>TAUPE</b> <i>Fabric</i>	 <b>BLACK</b> <i>Fabric</i>
	<b>STANDARD</b> 325 x 200 cm	<b>€ 3620</b> KSH001	<b>€ 3620</b> KSH002	<b>€ 3620</b> KSH003
	<b>HIGH</b> 15 cm extra height 325 x 215 cm	<b>€ 3750</b> KSH004	<b>€ 3750</b> KSH005	<b>€ 3750</b> KSH006
	<b>STANDARD + LED LIGHT</b> IP65 - 3000K 325 x 200 cm	<b>€ 4145</b> KSH007	<b>€ 4145</b> KSH008	<b>€ 4145</b> KSH009
	<b>HIGH + LED LIGHT</b> IP65 - 3000K   15 cm extra height 325 x 215 cm	<b>€ 4270</b> KSH010	<b>€ 4270</b> KSH011	<b>€ 4270</b> KSH012



### Friends of the product

Kosmos

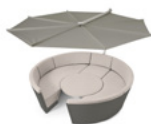

→ p78

Walrus



→ p156





## SQUARE SHADE

Outer dimensions (l x w x h)

High-tech polyester fabric + Stainless steel pole AISI 316 | Cover included

Shade + LED: In countries where this type of plug is not used, a different plug will need to be fitted (cable = 10 meter)

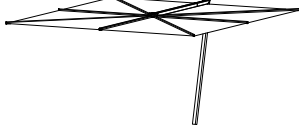
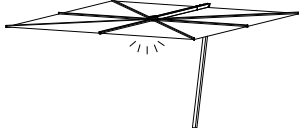
		 <b>WHITE</b> <i>Fabric</i>	 <b>TAUPE</b> <i>Fabric</i>	 <b>BLACK</b> <i>Fabric</i>
	<b>STANDARD</b> 325 x 325 x 200 cm	<b>€ 3955</b> KSH013	<b>€ 3955</b> KSH014	<b>€ 3955</b> KSH015
	<b>HIGH</b> 15 cm extra height 325 x 325 x 215 cm	<b>€ 4065</b> KSH016	<b>€ 4065</b> KSH017	<b>€ 4065</b> KSH018
	<b>STANDARD + LED LIGHT</b> IP65 - 3000K 325 x 325 x 200 cm	<b>€ 4490</b> KSH019	<b>€ 4490</b> KSH020	<b>€ 4490</b> KSH021
	<b>HIGH + LED LIGHT</b> IP65 - 3000K   15 cm extra height 325 x 325 x 215 cm	<b>€ 4610</b> KSH022	<b>€ 4610</b> KSH023	<b>€ 4610</b> KSH024

## CONNECTION OPTIONS

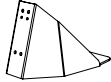
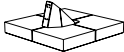
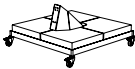
	<b>FLOOR FASTENING</b> Stainless steel parasol base Anchoring materials not included	<b>€ 390</b> KSH025
	<b>CONCRETE BASE</b> Including parasol base 125 kg - 76 x 76 x 32,5 cm	<b>€ 810</b> KSH026
	<b>CONCRETE WHEEL BASE</b> Including parasol base 140 kg - 82 x 82 x 40 cm	<b>€ 1435</b> KSH027

# KOSMOS SHADE ROUND COMBINATIONS

Stand alone - Kosmos 8-seater

Kosmos shade round +  
floor fastening

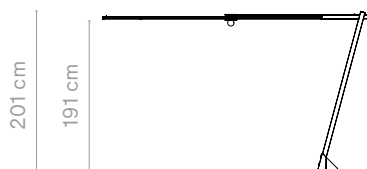

Kosmos shade round high +  
floor fastening

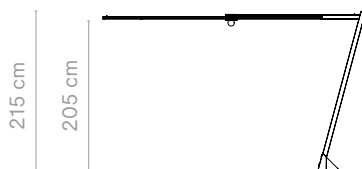

Kosmos shade round +  
concrete base

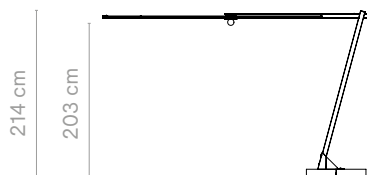

Kosmos shade round high +  
concrete base



Kosmos shade round +  
concrete wheel base

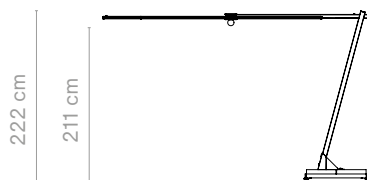

Kosmos shade round high +  
concrete wheel base



Kosmos shade round +  
Kosmos 8-seater

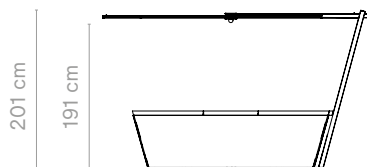

Kosmos shade round high +  
Kosmos 8-seater

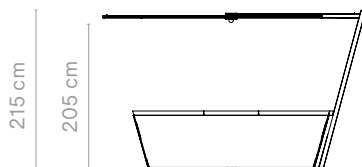

# KOSMOS SHADE SQUARE COMBINATIONS

Stand alone

Kosmos shade square +  
floor fastening

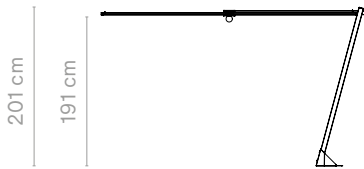

Kosmos shade square high +  
floor fastening

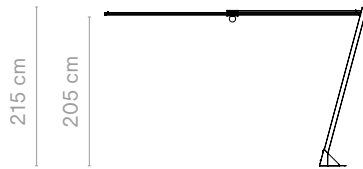

Kosmos shade square +  
concrete base



Kosmos shade square high +  
concrete base

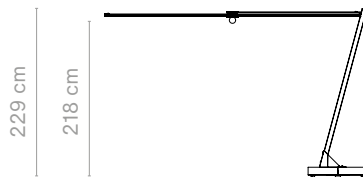

Kosmos shade square +  
concrete wheel base



Kosmos shade square high +  
concrete wheel base

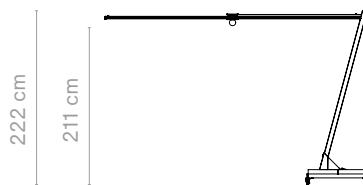

# Manille

© design by Dirk Wynants

NEW

Designed as a table with bench formation, this picnic table comfortably accommodates up to four people on the benches while the head of the table is reserved for wheelchair users - making Manille an inclusive and accessible table for everyone; a true tool for togetherness. What makes this picnic table stand out is its versatility. Extend the table in length by connecting multiple tables together. Thanks to a simple connection piece, you can join as many tables as you want. The shade creates an intimate cocoon whenever you need it.



Check availability  
[www.extremis.com/portal](http://www.extremis.com/portal)



Wheelchair accessible  
 → p179



## MANILLE

Outer dimensions (l x w x h): 144 x 177 x 74 cm - 4 people

Structured powder coated stainless steel legs + Galvanized steel frame + Hellwood tabletop & benches

Hellwood = 100% PEFC



		<b>EARTH</b> RGB 88 88 84	<b>€ 3850</b> MNL001
		<b>COPPER BROWN</b> RAL8004	<b>€ 3850</b> MNL002
		<b>COSMIC CREAM</b> RAL1015	<b>€ 3850</b> MNL003
		<b>PISTACHE</b> RAL6021	<b>€ 4085</b> MNL004
		<b>COLOR ON REQUEST</b> Only RAL colors Startup fee € 300 (ex. VAT)	<b>€ 3950</b> MNL005

## SHADE

Outer dimensions (l x w x h): 171 x 245 x 187 cm

Stainless steel poles + High-tech polyester fabric

Only compatible with the Manille | Storage bag for canopy included

		<b>WHITE</b>	<b>€ 1150</b> MNL006
---	---	--------------	-------------------------



## COUPLING

Outer dimensions (l x w x h): 71 x 51 x 6 cm

Hellwood tabletop + Galvanized steel frame

Hellwood = 100% PEFC

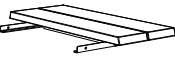

			<b>€ 495</b> MNL007
---	---	--	------------------------

## FLOOR FASTENING

Anchoring materials not included



Stainless steel  
1 set: 2 pieces

€ 60/set  
MNL008

## MANILLE

How many people can sit on a Manille?

144 cm  
4 people

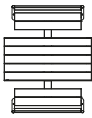

317 cm  
8 people

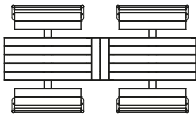

490 cm  
12 people

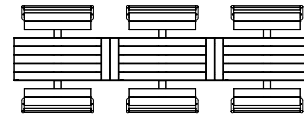

663 cm  
16 people

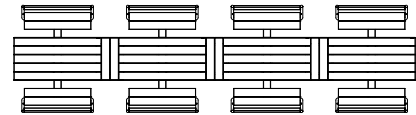

## MANILLE COMBINATION

With shade



€ 5000

## MANILLE COMBINATION

With three shades & two coupling pieces



€ 15990

# Marina combo

© design by Metrica

A combination of chairs and benches is what makes this range really unique. You can have a frequent use zone with Captain's Chairs that offer high comfort, and still have plenty of visitors over, offering seats on the benches.

Other combinations on request. If the length of the table exceeds 6m, special transport surcharges might be applicable.



 Check availability  
www.extremis.com/portal

 Wheelchair accessible  
→ p178

 Power options  
→ p100

 Cushions → p91  
Floor fastening → p89

## HOW DO I GET THE CORRECT PRODUCT CODE?

Complement the dots with the correct color code mentioned below

 <b>OFF WHITE</b> RAL9002	 <b>VERDIGRIS</b> RGB 133 147 142	 <b>REED GREEN</b> RAL6013	 <b>COPPER BROWN</b> RAL8004	 <b>ON REQUEST</b> Only RAL colors Startup fee € 300 (ex. VAT)
MAO...	MAV...	MAG...	MAC...	MAQ... + 5% surcharge per piece

## 3 LEGS

Outer dimensions 5 profiles (l x w x h): L x 155 x 75 cm | Outer dimensions 6 profiles (l x w x h): L x 170 x 75 cm

Structured powder coated zinced steel legs + coated fiberglass reinforced polyester tabletop & benches

	5 PROFILES Tabletop width 72 cm	6 PROFILES Tabletop width 87 cm	
	<b>L 360 CM</b> Bench length 165 cm	<b>€ 4890</b> ...003	<b>€ 5495</b> ...004
	<b>L 415 CM</b> Bench length 220 cm	<b>€ 5675</b> ...005	<b>€ 6385</b> ...006
	<b>L 470 CM</b> Bench length 275 cm	<b>€ 6450</b> ...007	<b>€ 7235</b> ...008
	<b>L 485 CM</b> Bench length 220 cm	<b>€ 6270</b> ...009	<b>€ 7070</b> ...010
	<b>L 595 CM</b> Bench length 330 cm	<b>€ 7435</b> ...011	<b>€ 8380</b> ...012



## Friends of the product

Captain's Chair



→ p36

Sensu



→ p120

#### 4 LEGS

Outer dimensions 5 profiles (l x w x h): L x 155 x 75 cm | Outer dimensions 6 profiles (l x w x h): L x 170 x 75 cm

Structured powder coated zinc steel legs + coated fiberglass reinforced polyester tabletop & benches

		<b>5 PROFILES</b> <i>Tabletop width 72 cm</i>	<b>6 PROFILES</b> <i>Tabletop width 87 cm</i>
	<b>L 595 CM</b> Bench length 165 cm   165 cm	<b>€ 8125</b> ...013	<b>€ 9085</b> ...014

#### 5 LEGS

Outer dimensions 5 profiles (l x w x h): L x 155 x 75 cm | Outer dimensions 6 profiles (l x w x h): L x 170 x 75 cm

Structured powder coated zinc steel legs + coated fiberglass reinforced polyester tabletop & benches

		<b>5 PROFILES</b> <i>Tabletop width 72 cm</i>	<b>6 PROFILES</b> <i>Tabletop width 87 cm</i>
	<b>L 665 CM</b> Bench length 165 cm   165 cm	<b>€ 9080</b> ...015	<b>€ 10200</b> ...016

#### MARINA COMBO + CAPTAIN'S CHAIRS

How many people can sit on a Marina combo?

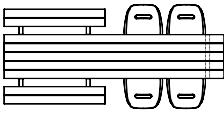
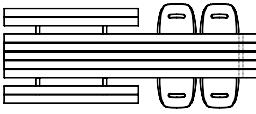
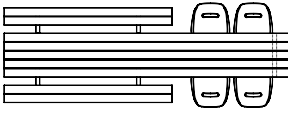
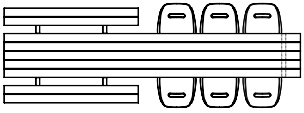
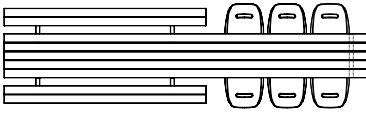
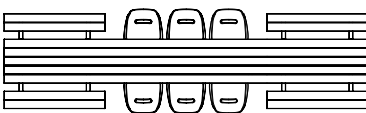
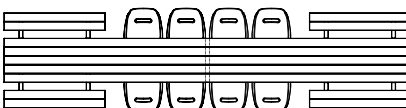
3 legs	<b>360 cm</b> 10 people (4 Captain's Chairs)	
	<b>415 cm</b> 12 people (4 Captain's Chairs)	
	<b>470 cm</b> 14 people (4 Captain's Chairs)	
	<b>485 cm</b> 14 people (6 Captain's Chairs)	
	<b>595 cm</b> 18 people (6 Captain's Chairs)	
4 legs	<b>595 cm</b> 18 people (6 Captain's Chairs)	
5 legs	<b>665 cm</b> 20 people (8 Captain's Chairs)	

# Marina picnic

© design by Metrica

The marvel of the Marina picnic design is that the tabletop is one seamless piece, creating a calm and uninterrupted aesthetic. With benches on both sides, this piece is a perfect example of the Extremis 'Tools for Togetherness' philosophy, bringing up to 26 people together at standard lengths of up to 7,15 meters. If the length of the table exceeds 6m, special transport surcharges might be applicable.



- 

Check availability  
[www.extremis.com/portal](http://www.extremis.com/portal)
- 

Wheelchair accessible  
→ p178
- 

Power options  
→ p100
- 

Cushions → p91  
Floor fastening → p89

## HOW DO I GET THE CORRECT PRODUCT CODE?

Complement the dots with the correct color code mentioned below

 <b>OFF WHITE</b> <small>RAL9002</small>	 <b>VERDIGRIS</b> <small>RGB 133 147 142</small>	 <b>REED GREEN</b> <small>RAL6013</small>	 <b>COPPER BROWN</b> <small>RAL8004</small>	 <b>ON REQUEST</b> <small>Only RAL colors Startup fee € 300 (ex. VAT)</small>
MAO...	MAV...	MAG...	MAC...	MAQ... <small>+ 5% surcharge per piece</small>

## 2 LEGS

Outer dimensions 5 profiles (l x w x h): L x 155 x 75 cm | Outer dimensions 6 profiles (l x w x h): L x 170 x 75 cm

Structured powder coated zinc steel legs + coated fiberglass reinforced polyester tabletop & benches | 55cm/person

	<b>5 PROFILES</b> <small>Tabletop width 72 cm</small>	<b>6 PROFILES</b> <small>Tabletop width 87 cm</small>
	<b>L 165 CM</b> € 3190 <small>...021</small>	<b>€ 3445</b> <small>...022</small>
	<b>L 220 CM</b> € 3970 <small>...023</small>	<b>€ 4315</b> <small>...024</small>
	<b>L 275 CM</b> € 4720 <small>...025</small>	<b>€ 5155</b> <small>...026</small>
	<b>L 330 CM</b> € 5425 <small>...001</small>	<b>€ 5755</b> <small>...027</small>



### Friends of the product

**Sensu**

→ p120





### 3 LEGS

Outer dimensions 5 profiles (l x w x h): L x 155 x 75 cm | Outer dimensions 6 profiles (l x w x h): L x 170 x 75 cm

Structured powder coated zinc coated steel legs + coated fiberglass reinforced polyester tabletop & benches | 55cm/person

	<b>5 PROFILES</b> <i>Tabletop width 72 cm</i>	<b>6 PROFILES</b> <i>Tabletop width 87 cm</i>
	<b>L 385 CM</b> ...028	<b>€ 6515</b> ...029
	<b>L 440 CM</b> ...030	<b>€ 7325</b> ...031
	<b>L 495 CM</b> ...032	<b>€ 8090</b> ...033
	<b>L 550 CM</b> ...034	<b>€ 8300</b> ...035

### 4 LEGS

Outer dimensions 5 profiles (l x w x h): L x 155 x 75 cm | Outer dimensions 6 profiles (l x w x h): L x 170 x 75 cm

Structured powder coated zinc coated steel legs + coated fiberglass reinforced polyester tabletop & benches | 55cm/person

	<b>5 PROFILES</b> <i>Tabletop width 72 cm</i>	<b>6 PROFILES</b> <i>Tabletop width 87 cm</i>
	<b>L 605 CM</b> ...036	<b>€ 9360</b> ...037
	<b>L 660 CM</b> ...038	<b>€ 10095</b> ...039
	<b>L 715 CM</b> ...040	<b>€ 10800</b> ...041

### FLOOR FASTENING SET

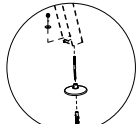
	<p>Bolts included Not for Marina Bistro 1 set: 2 pieces</p>	<p><b>€ 75/set</b> MAR121</p>
---	---	-----------------------------------

## MARINA PICNIC

How many people can sit on a Marina picnic?

Legs	Length (cm)	Capacity (people)	Legs	Length (cm)	Capacity (people)
2 legs	165 cm	6 people	4 legs	605 cm	22 people
	220 cm	8 people		660 cm	24 people
	275 cm	10 people		715 cm	26 people
	330 cm	12 people			
3 legs	385 cm	14 people			
	440 cm	16 people			
	495 cm	18 people			
	550 cm	20 people			

## MARINA PICNIC - MADE TO MEASURE

Formulas for calculating the price of the tables with custom sizes

	<b>PRICE OF CUSTOM LENGTH (5 PROFILES)</b> Price of the table of the next standard length	<b>+ € 200</b>
	<b>PRICE OF CUSTOM LENGTH (6 PROFILES)</b> Price of the table of the next standard length	<b>+ € 220</b>

### Examples

	<b>CUSTOM LENGTH: 250 X 154 X 75 CM</b> € 4490 (Price MAV025) + € 200	<b>+ € 4690</b>
	<b>CUSTOM LENGTH: 250 X 170 X 75 CM</b> € 4910 (Price MAV026) + € 220	<b>+ € 5130</b>











## CUSHIONS

Outer dimensions (l x w x t) - 1 piece

Pick the cushion according to the length of your bench

Please store the cushions inside when not in use

	<b>165 CM</b> <i>165 x 29 x 3 cm</i>	<b>220 CM</b> <i>220 x 29 x 3 cm</i>	<b>275 CM</b> <i>275 x 29 x 3 cm</i>	
	<b>GREY CHINÉ</b> Sunbrella® Natté	<b>€ 355</b> MAR789	<b>€ 465</b> MAR791	<b>€ 560</b> MAR793
	<b>DARK TAUPE</b> Sunbrella® Natté	<b>€ 355</b> MAR803	<b>€ 465</b> MAR804	<b>€ 560</b> MAR805
	<b>MARBLE</b> Sunbrella® Lopi	<b>€ 450</b> MAR776	<b>€ 555</b> MAR790	<b>€ 660</b> MAR792
	<b>LEAF GREEN</b> Sunbrella® Heritage	<b>€ 355</b> MAR809	<b>€ 465</b> MAR810	<b>€ 560</b> MAR811
	<b>RUST</b> Sunbrella® Heritage	<b>€ 355</b> MAR812	<b>€ 465</b> MAR813	<b>€ 560</b> MAR814
	<b>COLOR ON REQUEST 1</b> Only for Sunbrella Natté, Solids, Savane & Heritage	<b>€ 380</b> MAR794	<b>€ 490</b> MAR797	<b>€ 585</b> MAR800
	<b>COLOR ON REQUEST 2</b> Only for Sunbrella Chartres	<b>€ 425</b> MAR795	<b>€ 545</b> MAR798	<b>€ 625</b> MAR801
	<b>COLOR ON REQUEST 3</b> Only for Sunbrella Lopi, Domino & Zori	<b>€ 475</b> MAR796	<b>€ 580</b> MAR799	<b>€ 685</b> MAR802

# Marina double desk

© design by Metrica

The Marina double desk is perfect for office environments. The desk has two tabletops with only one set of legs, an ideal solution for open-plan offices. The fiberglass tabletop is very strong, yet it feels as pleasant as wood. In between the desk, there's a space for plugs and cables or extra accessories.

Other lengths and accessories on request. If the length of the table exceeds 6m, special transport surcharges might be applicable.



 Check availability  
www.extremis.com/portal

 Wheelchair accessible  
→ p178

 Power options  
→ p100

## HOW DO I GET THE CORRECT PRODUCT CODE?

Complement the dots with the correct color code mentioned below

 <b>OFF WHITE</b> RAL9002	 <b>VERDIGRIS</b> RGB 133 147 142	 <b>REED GREEN</b> RAL6013	 <b>COPPER BROWN</b> RAL8004	 <b>ON REQUEST</b> Only RAL colors Startup fee € 300 (ex. VAT)
MAO...	MAV...	MAG...	MAC...	MAQ... + 5% surcharge per piece

## 2 LEGS

Outer dimensions 2 x 5 profiles (l x w x h): L x 149 x 75 cm | Outer dimensions 2 x 6 profiles (l x w x h): L x 178 x 75 cm  
 Structured powder coated zinc steel legs + coated fiberglass reinforced polyester tabletop | 70cm/Captain's Chair

	<b>2 X 5 PROFILES</b> <i>Tabletop width 149 cm</i>	<b>2 X 6 PROFILES</b> <i>Tabletop width 178 cm</i>
	<b>L 405 CM</b>	
	<b>€ 7000</b> ...122	<b>€ 8330</b> ...123

## MONITOR HOLDER

	Stainless steel 316	<b>€ 355</b> MAR770
---	---------------------	------------------------



### Friends of the product

**Captain's Chair**

→ p36



**Sensu**

→ p120



## MARINA DOUBLE DESK - MADE TO MEASURE

Formulas for calculating the price of the tables with custom sizes



### PRICE OF CUSTOM LENGTH (5 OR 6 PROFILES)

2 x price of table of the next standard length - (number of legs x € 50)

### Examples



### CUSTOM LENGTH: 500 X 72 X 75 CM

2 x € 4710 (Price MAV069) - (3 x € 50)

**+ € 9270**

# Marina tables

© design by Metrica

The Marina table set is available without the attached seating benches to create a free-standing table. Marina table is not only unlimited in length, you can also extend the long architectural lines from the terrace through to the dining room, from the office workspace through to the office canteen. Boundaries blur between work and play, indoors and outdoors. If the length of the table exceeds 6m, special transport surcharges might be applicable.



 Check availability  
www.extremis.com/portal

 Wheelchair accessible  
→ p178

 Power options  
→ p100

## HOW DO I GET THE CORRECT PRODUCT CODE?

Complement the dots with the correct color code mentioned below

 <b>OFF WHITE</b> RAL9002	 <b>VERDIGRIS</b> RGB 133 147 142	 <b>REED GREEN</b> RAL6013	 <b>COPPER BROWN</b> RAL8004	 <b>ON REQUEST</b> <i>Only RAL colors</i> <i>Startup fee € 300 (ex. VAT)</i>
MAO...	MAV...	MAG...	MAC...	MAQ... + 5% surcharge per piece

## BISTRO

Outer dimensions (l x w x h): L x 72 x 75 cm

Structured powder coated zinced steel legs + coated fiberglass reinforced polyester tabletop | 70 cm/Captain's Chair

\* Leaving the collection. Available while supplies last

	<b>L 72 CM *</b>	<b>€ 2080</b> ...089
	<b>L 144 CM *</b>	<b>€ 2630</b> ...090



### Friends of the product

Captain's Chair



→ p36

Sensu



→ p120

### TABLE - 2 LEGS

Outer dimensions 5 profiles (l x w x h): L x 72 x 75 cm | Outer dimensions 6 profiles (l x w x h): L x 87 x 75 cm

Structured powder coated zinc coated steel legs + coated fiberglass reinforced polyester tabletop | 70 cm/Captain's Chair

	<b>5 PROFILES</b> <i>Tabletop width 72 cm</i>	<b>6 PROFILES</b> <i>Tabletop width 87 cm</i>
	<b>L 195 CM</b> ...060	<b>€ 2195</b> ...061
	<b>L 265 CM</b> ...062	<b>€ 2750</b> ...063
	<b>L 335 CM</b> ...064	<b>€ 3335</b> ...065
	<b>L 405 CM</b> ...066	<b>€ 3660</b> ...067

### TABLE - 3 LEGS

Outer dimensions 5 profiles (l x w x h): L x 72 x 75 cm | Outer dimensions 6 profiles (l x w x h): L x 87 x 75 cm

Structured powder coated zinc coated steel legs + coated fiberglass reinforced polyester tabletop | 70 cm/Captain's Chair

	<b>5 PROFILES</b> <i>Tabletop width 72 cm</i>	<b>6 PROFILES</b> <i>Tabletop width 87 cm</i>
	<b>L 475 CM</b> ...068	<b>€ 4415</b> ...002
	<b>L 545 CM</b> ...069	<b>€ 4950</b> ...070
	<b>L 615 CM</b> ...071	<b>€ 5525</b> ...072
	<b>L 685 CM</b> ...073	<b>€ 6030</b> ...074

### FLOOR FASTENING SET

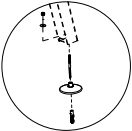
	<p>Bolts included Not for Marina Bistro 1 set: 2 pieces</p>	<p><b>€ 75/set</b> MAR121</p>
---	---	-----------------------------------

# Marina high table

© design by Metrica

The Marina table is also available in a high version, 105 cm to be precise. Extend the architectural lines of the table from your terrace to your dining room and from your office workspace to your office canteen. Whether indoors or outdoors, these tables blur the boundaries between work and play and turn an individual space into a shared one. If the length of the table exceeds 6m, special transport surcharges might be applicable.



 Check availability  
www.extremis.com/portal

 Power options  
→ p100

## HOW DO I GET THE CORRECT PRODUCT CODE?

Complement the dots with the correct color code mentioned below

 <b>OFF WHITE</b> RAL9002	 <b>VERDIGRIS</b> RGB 133 147 142	 <b>REED GREEN</b> RAL6013	 <b>COPPER BROWN</b> RAL8004	 <b>ON REQUEST</b> <i>Only RAL colors</i> <i>Startup fee € 300 (ex. VAT)</i>
MAO...	MAV...	MAG...	MAC...	MAQ... + 5% surcharge per piece

## HIGH TABLE - 2 LEGS

Outer dimensions 5 profiles (l x w x h): L x 72 x 105 cm | Outer dimensions 6 profiles (l x w x h): L x 87 x 105 cm

Structured powder coated zinced steel legs + coated fiberglass reinforced polyester tabletop | 70cm/Captain's Chair

		5 PROFILES <i>Tabletop width 72 cm</i>	6 PROFILES <i>Tabletop width 87 cm</i>
	<b>L 195 CM</b>	<b>€ 2305</b> ...091	<b>€ 2635</b> ...092
	<b>L 265 CM</b>	<b>€ 2860</b> ...093	<b>€ 3295</b> ...094
	<b>L 335 CM</b>	<b>€ 3445</b> ...095	<b>€ 4010</b> ...096
	<b>L 405 CM</b>	<b>€ 3770</b> ...097	<b>€ 4410</b> ...098



### Friends of the product

Captain's Chair  
high



→ p36

Sensu



→ p120

Tiki  
bar stool



→ p140



## HIGH TABLE - 3 LEGS

Outer dimensions 5 profiles (l x w x h): L x 72 x 105 cm | Outer dimensions 6 profiles (l x w x h): L x 87 x 105 cm

Structured powder coated zinc steel legs + coated fiberglass reinforced polyester tabletop | 70cm/Captain's Chair

		<b>5 PROFILES</b> <i>Tabletop width 72 cm</i>	<b>6 PROFILES</b> <i>Tabletop width 87 cm</i>
	<b>L 475 CM</b>	<b>€ 4580</b> ...099	<b>€ 5300</b> ...100
	<b>L 545 CM</b>	<b>€ 5115</b> ...101	<b>€ 5965</b> ...102
	<b>L 615 CM</b>	<b>€ 5690</b> ...103	<b>€ 6645</b> ...104
	<b>L 685 CM</b>	<b>€ 6195</b> ...105	<b>€ 7255</b> ...106

## FLOOR FASTENING SET

	<p>Bolts included Not for Marina Bistro 1 set: 2 pieces</p>	<p><b>€ 75/set</b> MAR121</p>
--	---	-----------------------------------

## MADE TO MEASURE

Formulas for calculating the price of the tables with custom sizes

	<b>PRICE OF CUSTOM LENGTH (5 PROFILES)</b> Price of the table of the next standard length	<b>+ € 135</b>
	<b>PRICE OF CUSTOM LENGTH (6 PROFILES)</b> Price of the table of the next standard length	<b>+ € 150</b>

### Examples

	<b>CUSTOM LENGTH: 250 X 72 X 75 CM</b> € 2615 (Price MAV062) + € 135	<b>€ 2750</b>
	<b>CUSTOM LENGTH: 250 X 87 X 75 CM</b> € 3050 (Price MAV063) + € 150	<b>€ 3200</b>

**MARINA (HIGH) TABLE & DOUBLE DESK + CAPTAIN'S CHAIRS**

How many people can sit on a Marina (high) table & Marina double desk?

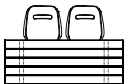
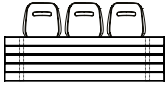
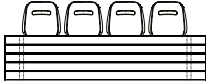
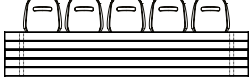
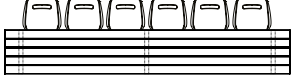
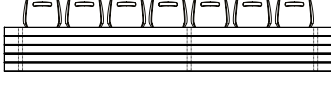
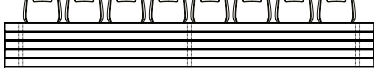
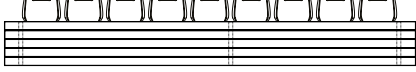
2 legs	195 cm		
	4 Captain's Chairs		
	265 cm		
	6 Captain's Chairs		
	335 cm		
8 Captain's Chairs			
3 legs	405 cm		
	10 Captain's Chairs		
	475 cm		
	12 Captain's Chairs		
	545 cm		Position of the legs is asymmetrical
	14 Captain's Chairs		
	615 cm		
16 Captain's Chairs			
685 cm		Position of the legs is asymmetrical	
18 Captain's Chairs			

**WIRELESS POWER - OUTDOOR & INDOOR**

Outer dimensions (ø): 8 cm

Wireless charger on top, compatible with all devices with wireless charging system

It has a quick charge system | One battery included

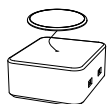

2 x USB on battery pack  
 Battery 55 wh - Antenna 5w  
 IP65 & Shockproof

**€ 395**  
 ELE001

**CHARGING TRAY FOR WIRELESS POWER**

Outer dimensions (l x w x h): 24 x 8 x 9 cm

Charges up to four stations simultaneously in 7 hours | 4 charging slots

Includes magnetic key to remove the station from its support

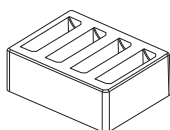

For Europe

**€ 280**  
 ELE002

For United Kingdom

**€ 280**  
 ELE003

For United States

**€ 280**  
 ELE004

Wireless power



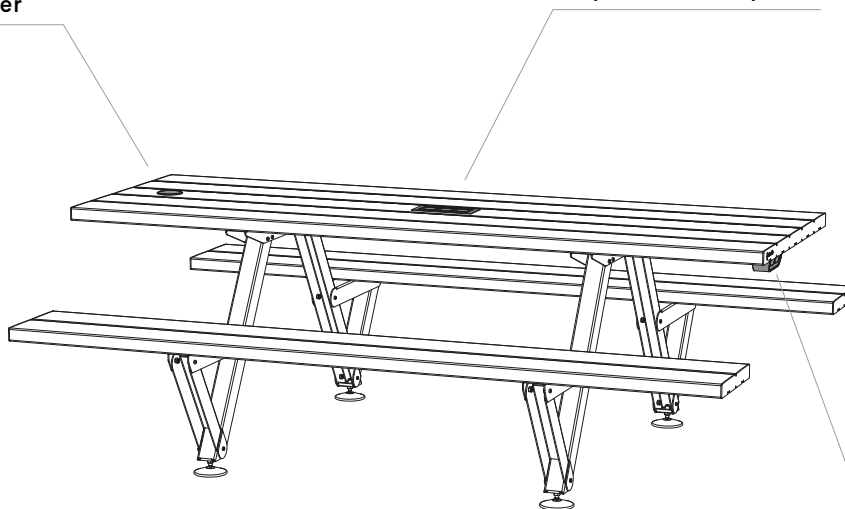

Square in-table power



Under table power

## HOW DO I GET THE CORRECT PRODUCT CODE FOR MY POWER MODULE?

Complement the dots with the correct code mentioned below



 <b>SHUKO</b> <i>Europe type F</i>	 <b>UNITED STATES</b> <i>Type B</i>	 <b>UNITED KINGDOM</b> <i>Type G</i>	 <b>SWITZERLAND</b> <i>Type J</i>
.....SO	.....US	.....UK	.....CH

## UNDER TABLE POWER - INDOOR USE ONLY

Outer dimensions (l x w x h): 14 x 8 x 8 cm

Caution, no plug is supplied with the 3-meter cable as there are different types of plugs and sockets around the globe

To be fixed underneath the tabletop

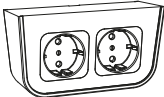
		 <b>WHITE</b>	 <b>BLACK</b>
	<b>2 X SOCKETS</b>	<b>€ 130</b> ELE007...	<b>€ 130</b> ELE009...
	<b>SOCKET + USB</b> USB & USB-C	<b>€ 240</b> ELE006...	<b>€ 240</b> ELE008...

## SQUARE IN-TABLE POWER - INDOOR USE ONLY

Outer dimensions (l x w): 19 x 8 cm

Caution, no plug is supplied with the 3-meter cable as there are different types of plugs and sockets around the globe

Cut-out in tabletop included

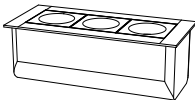
		<b>3 X SOCKET</b> Black	<b>€ 310</b> ELE010...
		<b>2 X SOCKET + USB</b> Black USB & USB-C	<b>€ 420</b> ELE011...

# Panigiri

© design by Dirk Wynants

NEW

'Pan giri' in Greek stands for 'gathering all,' and that's what this design is all about. Choose between a table with chairs, a picnic table, or a combination of both. The smart position of the benches allow easy entry without lifting your leg. Experience optimal comfort with BYOS (Bring Your Own Seat) and convenient slide-on cushions. The new Captain's Chairs Pipe Legs perfectly complement the organic, round shapes of this table.



The modular design of Panigiri offers you the freedom to add extra modules at a later time, to extend togetherness.



Check availability  
www.extremis.com/portal



Wheelchair accessible  
→ p179



Cushions → p103

## BASE MODULES

Outer dimensions (l x w x h) - Tabletop width 100 cm

Structured powder coated stainless steel legs + Galvanized steel frame + Hellwood tabletop & benches

Hellwood = 100% PEFC



### COMBO

326 x 180 x 74 cm - 8 people  
Possible to fit 4 to 6 chairs







### PICNIC

326 x 180 x 74 cm - 8 people  
Possible to fit 2 chairs



### TABLE

326 x 100 x 74 cm  
Possible to fit 8 to 10 chairs

	<b>BLACK</b> RAL9005	<b>€ 7000</b> PNG001	<b>€ 8455</b> PNG006	<b>€ 5545</b> PNG011
	<b>EARTH</b> RGB 88 88 84	<b>€ 7000</b> PNG002	<b>€ 8455</b> PNG007	<b>€ 5545</b> PNG012
	<b>BEACH BEIGE</b> RAL1019	<b>€ 7000</b> PNG003	<b>€ 8455</b> PNG008	<b>€ 5545</b> PNG013
	<b>OFF WHITE</b> RAL9002	<b>€ 7000</b> PNG004	<b>€ 8455</b> PNG009	<b>€ 5545</b> PNG014
	<b>ON REQUEST</b> Only RAL colors Startup fee € 300 (ex. VAT)	<b>€ 7250</b> PNG005	<b>€ 8755</b> PNG010	<b>€ 5745</b> PNG015



## Friends of the product

Captain's Chair  
pipe legs



→ p36

Sensu  
tilted



→ p121







## ADDITIONAL MODULES

Outer dimensions (l x w x h) - Tabletop width 100 cm

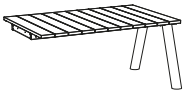
Structured powder coated stainless steel legs + Galvanized steel frame + Hellwood tabletop & benches

Hellwood = 100% PEFC



	 <b>PICNIC MODULE</b> 156 x 100 x 74 cm Adds 4 people	 <b>TABLE MODULE</b> 156 x 100 x 74 cm Adds 4 people
 <b>BLACK</b> RAL9005	<b>€ 4160</b> PNG016	<b>€ 2705</b> PNG021
 <b>EARTH</b> RGB 88 88 84	<b>€ 4160</b> PNG017	<b>€ 2705</b> PNG022
 <b>BEACH BEIGE</b> RAL1019	<b>€ 4160</b> PNG018	<b>€ 2705</b> PNG023
 <b>OFF WHITE</b> RAL9002	<b>€ 4160</b> PNG019	<b>€ 2705</b> PNG024
 <b>ON REQUEST</b> Only RAL colors Startup fee € 300 (ex. VAT)	<b>€ 4310</b> PNG020	<b>€ 2805</b> PNG025

## BYOS

Outer dimensions (l x w x h): 50 x 46 x 46 cm

Earth structured powder coated steel frame

Sunbrella fabric + Taupe polypropylene yarn

Please store the BYOS inside when not in use

		<b>COCONUT</b> Sunbrella® Savane	<b>€ 475</b> PNG027
		<b>MARBLE</b> Sunbrella® Lopi	<b>€ 495</b> PNG026

## SLIDE-ON CUSHION

Outer dimensions (l x w x h): 50 x 25 x 3 cm

Sunbrella fabric

This cushion effortlessly slides between the planks of the bench, ensuring it remains securely in place and won't blow away

Please store the cushions inside when not in use

		<b>COCONUT</b> Sunbrella® Savane	<b>€ 135</b> PNG029
		<b>MARBLE</b> Sunbrella® Lopi	<b>€ 150</b> PNG028

### PANIGIRI COMBO + ADDITIONAL PICNIC MODULE

Outer dimensions (l x w x h): 482 x 180 x 74 cm - 12 people | Possible to fit 4 to 6 Captain's Chairs

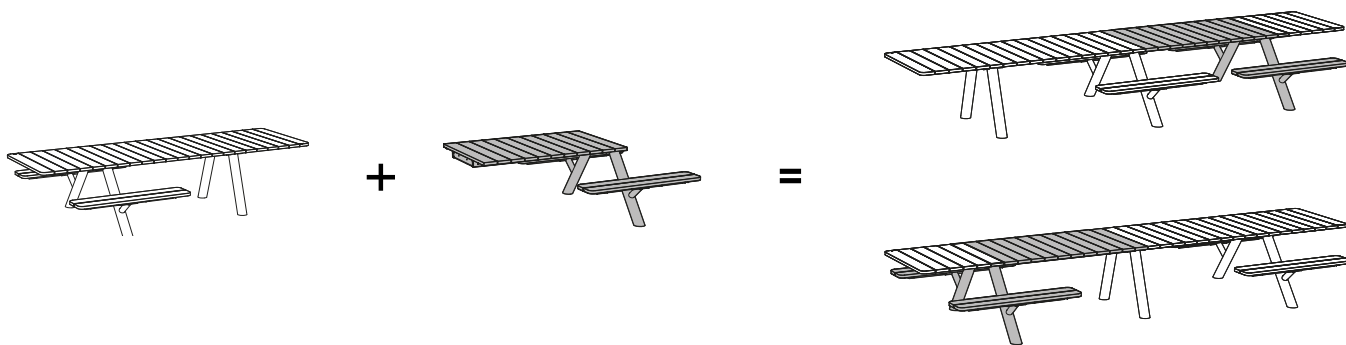

### PANIGIRI COMBO + ADDITIONAL TABLE MODULE

Outer dimensions (l x w x h): 482 x 180 x 74 cm - 12 people | Possible to fit 8 to 10 Captain's Chairs

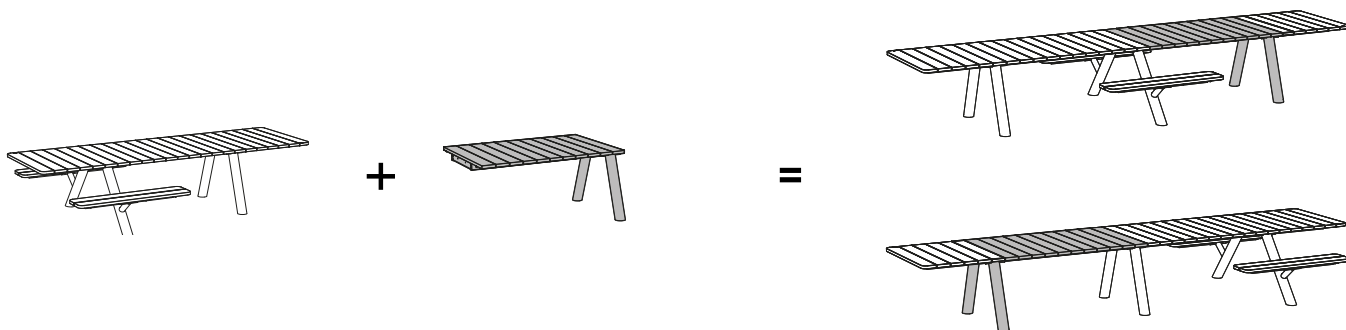

### PANIGIRI PICNIC + ADDITIONAL PICNIC MODULE

Outer dimensions (l x w x h): 482 x 180 x 74 cm - 12 people

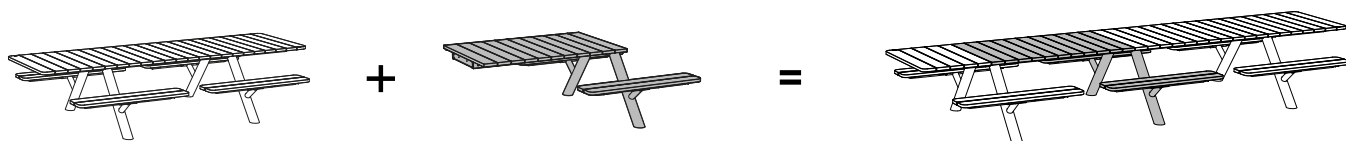

### PANIGIRI TABLE + ADDITIONAL TABLE MODULE

Outer dimensions (l x w x h): 482 x 100 x 74 cm - Possible to fit 12 to 14 Captain's Chairs

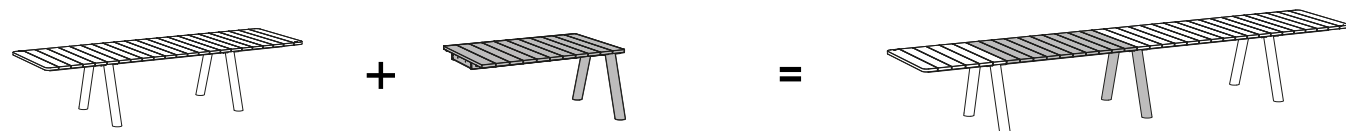



**PANIGIRI COMBO + CAPTAIN'S CHAIRS**

How many people can sit on a Panigiri combo?

**326 cm**  
8 people  
(4 to 6 Captain's Chairs)

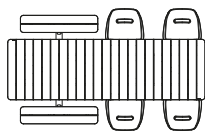

**482 cm**  
12 people  
(4 to 6 Captain's Chairs)

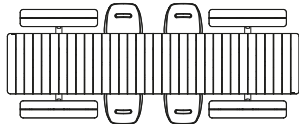

**482 cm**  
12 people  
(4 to 6 Captain's Chairs)

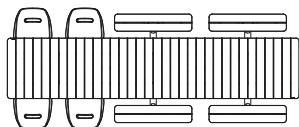

**638 cm**  
16 people  
(4 to 6 Captain's Chairs)

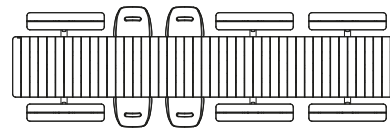

**638 cm**  
16 people  
(8 to 10 Captain's Chairs)

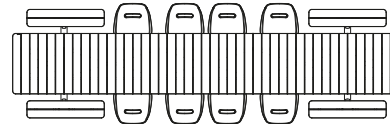

**794 cm**  
20 people  
(8 to 10 Captain's Chairs)

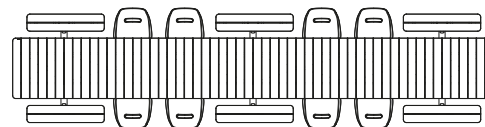

**PANIGIRI PICNIC**

How many people can sit on a Panigiri picnic?

**326 cm**  
8 people

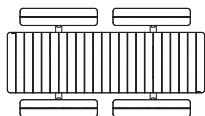

**482 cm**  
12 people

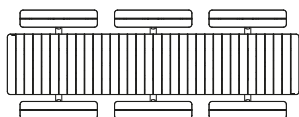

**638 cm**  
16 people

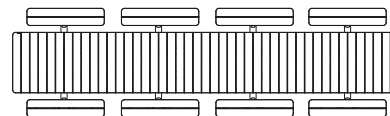

**794 cm**  
20 people

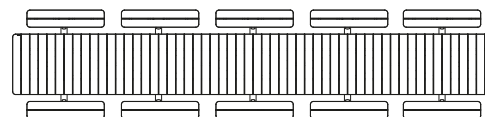

**PANIGIRI TABLE + CAPTAIN'S CHAIRS**

How many people can sit on a Panigiri table?

**326 cm**  
(8 to 10 Captain's Chairs)

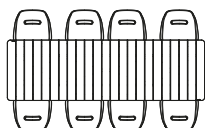

**482 cm**  
(12 to 14 Captain's Chairs)

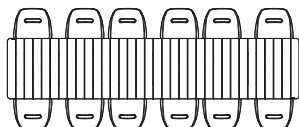

**638 cm**  
(16 to 18 Captain's Chairs)

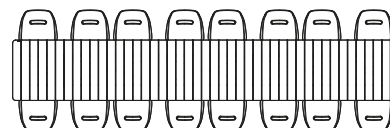

**794 cm**  
(20 to 22 Captain's Chairs)

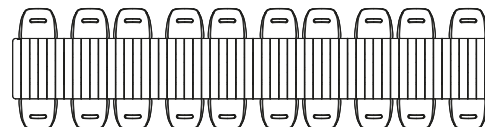

## PANIGIRI COMBINATIONS

Some predefined combinations

### PANIGIRI COMBO 326 CM + SENSU TILTED + CHAIRS

Panigiri combo 326 cm (Black) + 4 x Captain's Pipe Chairs (Black) + Sensu single square tilted with wheel base (Black)

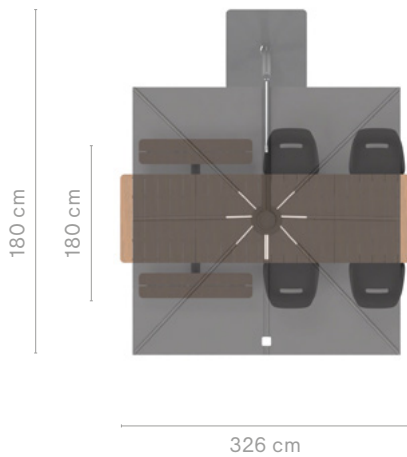

PNG001 + CAP002 (x4) + CAP030 (x4) + SEN189 + SEN067 € 13875

### PANIGIRI PICNIC 326 CM + BYOS

Panigiri picnic 326 cm (Beach beige) + 8 x BYOS (Coconut)

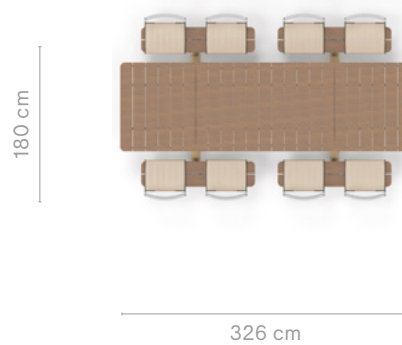

PNG008 + PNG027 (x8)

€ 12255

## PANIGIRI COMBINATIONS

Some predefined combinations

### PANIGIRI COMBO 482 CM + CHAIRS

Panigiri picnic 326 cm (Off white) + Panigiri additional table module (Off white) + 4 x Captain's Pipe Chairs (Off white legs & White shell)

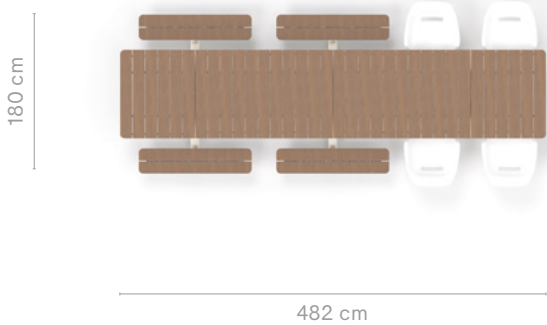

PNG009 + PNG024 + CAP001 (x4) + CAP033 (x4)

€ 12960

### PANIGIRI COMBO 482 CM + SENSU TILTED + CHAIRS

Panigiri combo 326 cm (Earth) + Panigiri additional picnic module (Earth) + 4 x Captain's Pipe Chairs (Earth) + 2 x Sensu single square tilted with wheel base (Earth)

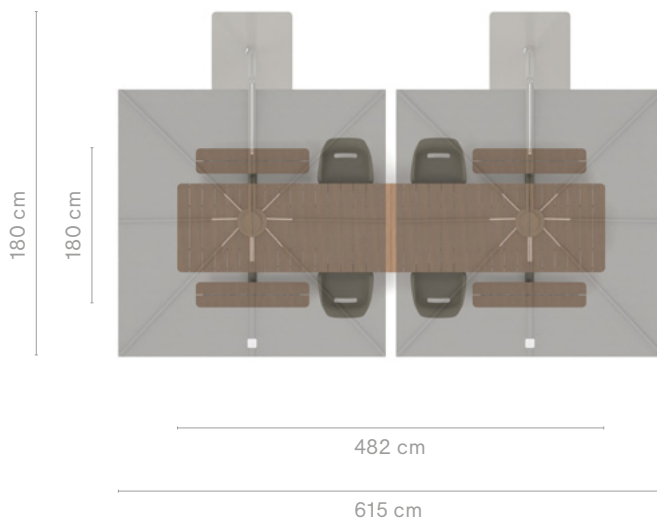

PNG002 + PNG017 + CAP271 (x4) + CAP031 (x4) +  
SEN185 (x2) + SEN069 (x2)

€ 23110

# Pantagruel picnic

© design by Dirk Wynants

The Pantagruel round picnic table seats eight. The frame is available in a powder coated or galvanized finish. When combined with the wood used for the tabletop and benches it forms a durable outdoor picnic set. Pantagruel also features a Lazy Susan, to take the hard work out of passing food and drinks around.



Check availability  
[www.extremis.com/portal](http://www.extremis.com/portal)



Power options  
 → p116











ø65 mm

Outer dimensions (ø x h): 227 x 75 cm

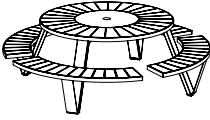
Galvanized steel legs & frames OR

Structured powder coated stainless steel legs + structured powder coated zinc steel tabletop- and bench frame

Hellwood = 100% PEFC

		  <b>HELLWOOD</b> <i>Thermally treated wood                      tabletop &amp; benches</i>	 <b>IROKO</b> <i>Tropical hardwood                      tabletop &amp; benches</i>
		<b>GALVANIZED STEEL</b> & White HPL Lazy Susan € 6415 PAN004	€ 6615 PAN009
		<b>BLACK</b> RAL9005 & Black HPL Lazy Susan € 7010 PAN003	€ 7220 PAN008
		<b>EARTH</b> RGB 88 88 84 & Earth HPL Lazy Susan € 7010 PAN002	€ 7220 PAN007
		<b>BEACH BEIGE</b> RAL1019 & White HPL Lazy Susan € 7010 PAN628	€ 7220 PAN624
		<b>OFF WHITE</b> RAL9002 & White HPL Lazy Susan € 7010 PAN626	€ 7220 PAN617
		<b>COLOR ON REQUEST</b> Only RAL colors Startup fee € 300 (ex. VAT) € 7350 PAN005	€ 7565 PAN010



## Friends of the product

Inumbra  
 medium / large



→ p72

Inumbra  
 large









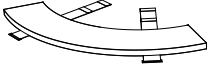

→ p74

## CUSHIONS

1 set: 4 pieces







Please store the cushions inside when not in use

		<b>GREY CHINÉ</b> Sunbrella® Natté	<b>€ 905/set</b> PAN489
		<b>DARK TAUPE</b> Sunbrella® Natté	<b>€ 905/set</b> PAN634
		<b>COCONUT</b> Sunbrella® Savane	<b>€ 905/set</b> PAN635
		<b>MARBLE</b> Sunbrella® Lopi	<b>€ 1220/set</b> PAN507
		<b>BISCUIT</b> Sunbrella® Lopi	<b>€ 1120/set</b> PAN633
		<b>COLOR ON REQUEST 1</b> Only for Sunbrella Natté, Solids, Savane & Heritage	<b>€ 930/set</b> PAN018
		<b>COLOR ON REQUEST 2</b> Only for Sunbrella Chartres	<b>€ 1040/set</b> PAN521
		<b>COLOR ON REQUEST 3</b> Only for Sunbrella Lopi, Domino & Zori	<b>€ 1145/set</b> PAN522

## BACKRESTS

Galvanized steel or Structured powder coated zinc steel

1 set: 2 pieces

		<b>GALVANIZED STEEL</b>	<b>€ 725/set</b> PAN011
		<b>BLACK</b> RAL9005	<b>€ 980/set</b> PAN012
		<b>EARTH</b> RGB 88 88 84	<b>€ 980/set</b> PAN013
		<b>BEACH BEIGE</b> RAL1019	<b>€ 980/set</b> PAN632
		<b>OFF WHITE</b> RAL9002	<b>€ 980/set</b> PAN630
		<b>COLOR ON REQUEST</b> Only RAL colors Startup fee € 300 (ex. VAT)	<b>€ 1030/set</b> PAN015

## OPTIONS

1 set: 4 pieces



**FLOOR FASTENING**  
Galvanized steel  
Anchoring materials not included

**€ 110/set**  
PAN019

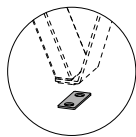

**PROTECTION FELT FOR INDOOR USE**  
Anthracite felt

**€ 45/set**  
PAN020

## CONNECTION OPTIONS

To combine with Inumbra or Inumbrina



**CONNECTION PIECE INUMBRA**  
Inumbra medium - large  
Stainless steel

**€ 240**  
INU007



**CONNECTION PIECE INUMBRINA**  
Inumbrina large  
Stainless steel  
Inner ø5 cm

**€ 185**  
INI010

**PANTAGRUEL PICNIC COMBINATION**  
With Inumbrina large (+ connection piece)



PAN617 + INI010 + INI001

**€ 10285**

**PANTAGRUEL PICNIC COMBINATION**  
With Inumbra large (+ connection piece) & 1 set backrests



PAN003 + PAN012  
+ INU007 + INU247

**€ 12680**

# Pantagrue table

© design by Dirk Wynants

The Pantagrue table easily seats eight. With several color and material options, it fits in any indoor or outdoor space. The round shape allows everyone to take part in the conversation and have eye contact, which makes it ideal for a round table meeting. The Lazy Susan in the center makes sharing easy with others around the table.



We recommend using floor fastening when combined with Inumbra.



Check availability  
www.extremis.com/portal



Power options  
→ p116











ø65 mm

Outer dimensions (ø x h): 146 x 75 cm

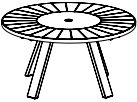
Galvanized steel legs & tabletop frame OR

Structured powder coated stainless steel legs + structured powder coated zinc steel tabletop frame

Hellwood = 100% PEFC

		 <b>HELLWOOD</b> <i>Thermally treated wood tabletop</i>	 <b>IROKO</b> <i>Tropical hardwood tabletop</i>
	 <b>BLACK</b> RAL9005 & Black HPL Lazy Susan	<b>€ 4105</b> PAN027	<b>€ 4205</b> PAN022
	 <b>EARTH</b> RGB 88 88 84 & Earth HPL Lazy Susan	<b>€ 4105</b> PAN028	<b>€ 4205</b> PAN023
	 <b>BEACH BEIGE</b> RAL1019 & White HPL Lazy Susan	<b>€ 4105</b> PAN600	<b>€ 4205</b> PAN602
	 <b>OFF WHITE</b> RAL9002 & White HPL Lazy Susan	<b>€ 4105</b> PAN596	<b>€ 4205</b> PAN604
	 <b>COLOR ON REQUEST</b> Only RAL colors Startup fee € 300 (ex. VAT)	<b>€ 4305</b> PAN030	<b>€ 4410</b> PAN025



## Friends of the product

Captain's Chair



→ p36

Inumbra  
medium / large



→ p72

Inumbra  
large



→ p74



## OPTIONS

1 set: 4 pieces



**FLOOR FASTENING**  
Galvanized steel  
Anchoring materials not included

**€ 110/set**  
PAN019

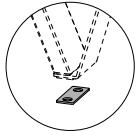

**PROTECTION FELT FOR INDOOR USE**  
Anthracite felt

**€ 45/set**  
PAN020

## CONNECTION OPTIONS

To combine with Inumbra or Inumbrina

We recommend using floor fastening when combined with Inumbra



**CONNECTION PIECE INUMBRA**  
Inumbra medium - large  
Stainless steel

**€ 240**  
INU007



**CONNECTION PIECE INUMBRINA**  
Inumbrina large  
Stainless steel  
Inner ø5 cm

**€ 185**  
INI010

# Pantagruel high table

© design by Dirk Wynants

Looking for a cocktail table with the refined yet sturdy Pantagruel look? Behold the Pantagruel high table. Eight chairs and even more stools fit around the extra-large tabletop. In the center you will find an HPL Lazy Susan, with which to easily pass things around. The light design uses highly durable, outdoor-resistant materials.

We recommend using floor fastening when combined with Inumbra. Can not be combined with Inumbra large.



Check availability  
www.extremis.com/portal



Power options  
→ p116











ø65 mm

Outer dimensions (ø x h): 146 x 105 cm

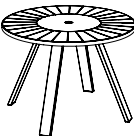
Galvanized steel legs & tabletop frame OR

Structured powder coated stainless steel legs + structured powder coated zinc steel tabletop frame

Hellwood = 100% PEFC

		  <b>HELLWOOD</b> <i>Thermally treated wood tabletop</i>	 <b>IROKO</b> <i>Tropical hardwood tabletop</i>	
		<b>BLACK</b> RAL9005 & Black HPL Lazy Susan	<b>€ 4430</b> PAN037	<b>€ 4530</b> PAN032
		<b>EARTH</b> RGB 88 88 84 & Earth HPL Lazy Susan	<b>€ 4430</b> PAN038	<b>€ 4530</b> PAN033
		<b>BEACH BEIGE</b> RAL1019 & White HPL Lazy Susan	<b>€ 4430</b> PAN612	<b>€ 4530</b> PAN607
		<b>OFF WHITE</b> RAL9002 & White HPL Lazy Susan	<b>€ 4430</b> PAN614	<b>€ 4530</b> PAN610
		<b>COLOR ON REQUEST</b> Only RAL colors Startup fee € 300 (ex. VAT)	<b>€ 4650</b> PAN040	<b>€ 4755</b> PAN035



## Friends of the product

Captain's Chair  
high



→ p36

Inumbra  
medium / large



→ p72

Tiki  
bar stool



→ p140

## OPTIONS

1 set: 4 pieces

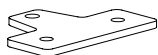

**FLOOR FASTENING**  
Galvanized steel  
Anchoring materials not included

**€ 110/set**  
PAN019

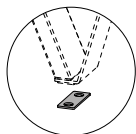

**PROTECTION FELT FOR INDOOR USE**  
Anthracite felt

**€ 45/set**  
PAN020

## CONNECTION OPTIONS

To combine with Inumbra

We recommend using floor fastening when combined with Inumbra



**CONNECTION PIECE INUMBRA**  
Inumbra medium - large  
Stainless steel

**€ 240**  
INU007

## WIRELESS POWER - OUTDOOR & INDOOR

Outer dimensions (ø): 8 cm

Wireless charger on top, compatible with all devices with wireless charging system

It has a quick charge system | One battery included

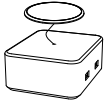

2 x USB on battery pack  
Battery 55 wh - Antenna 5w  
IP65 & Shockproof

**€ 395**  
ELE001

## CHARGING TRAY FOR WIRELESS POWER

Outer dimensions (l x w x h): 24 x 8 x 9 cm

Charges up to four stations simultaneously in 7 hours | 4 charging slots

Includes magnetic key to remove the station from its support

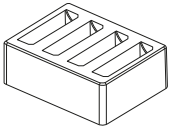

For Europe

**€ 280**  
ELE002

For United Kingdom

**€ 280**  
ELE003

For United States

**€ 280**  
ELE004

Wireless power



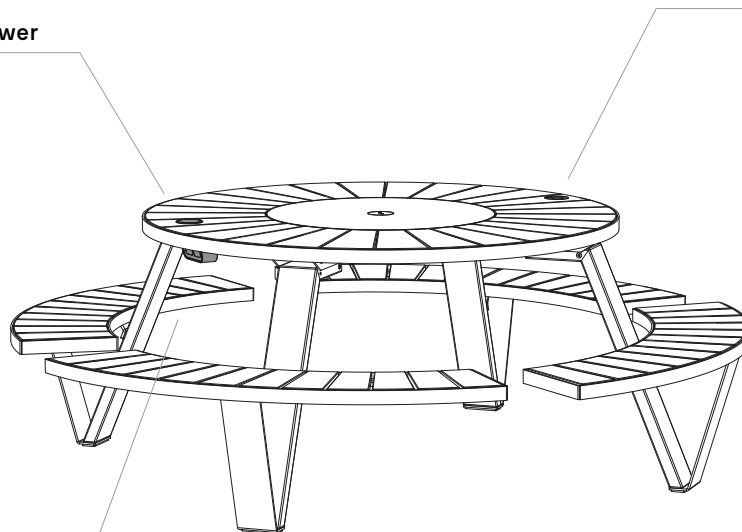

Round in-table power



Under table power

## HOW DO I GET THE CORRECT PRODUCT CODE FOR MY POWER MODULE?

Complement the dots with the correct code mentioned below



 <b>SHUKO</b> <i>Europe type F</i>	 <b>UNITED STATES</b> <i>Type B</i>	 <b>UNITED KINGDOM</b> <i>Type G</i>	 <b>SWITZERLAND</b> <i>Type J</i>
.....SO	.....US	.....UK	.....CH

## UNDER TABLE POWER - INDOOR USE ONLY

Outer dimensions (l x w x h): 14 x 8 x 8 cm

Caution, no plug is supplied with the 3-meter cable as there are different types of plugs and sockets around the globe

To be fixed underneath the tabletop

	 <b>WHITE</b>	 <b>BLACK</b>
	<b>2 X SOCKETS</b>  <b>€ 130</b> ELE007...	<b>€ 130</b> ELE009...
	<b>SOCKET + USB</b> USB & USB-C	<b>€ 240</b> ELE006...
		<b>€ 240</b> ELE008...

## ROUND IN-TABLE POWER - INDOOR USE ONLY

Outer dimensions (ø): 8 cm

Caution, no plug is supplied with the 3-meter cable as there are different types of plugs and sockets around the globe

Cut-out in tabletop included

		<b>SOCKET + USB</b> Black USB & USB-C	<b>€ 320</b> ELE013...
---	---	---	---------------------------

Picnik is made from a single sheet of aluminum, cut and bent to shape with zero waste. The form seats two people comfortably at the tabletop and withstands the harshest of the elements outdoors. A perfect example of 'form follows function', Picnik is a true design classic in the Extremis collection.











 Check availability  
[www.extremis.com/portal](http://www.extremis.com/portal)

 Wheelchair accessible  
 → p179

## STANDARD FEET

Outer dimensions (l x w x h): 147 x 95 x 75 cm









Structured powder coated aluminium + Stainless steel feet (6 pcs)

		<b>OFF WHITE</b> RAL9002	<b>€ 4615</b> PIC272
		<b>VERDIGRIS</b> RGB 133 147 142	<b>€ 4615</b> PIC003
		<b>COPPER BROWN</b> RAL8004	<b>€ 4615</b> PIC004
		<b>COBALT BLUE</b> RAL5013	<b>€ 5080</b> PIC005
		<b>SUN YELLOW</b> RAL1032	<b>€ 5080</b> PIC270
		<b>PISTACHE</b> RAL6021	<b>€ 5080</b> PIC274
		<b>ON REQUEST</b> Only RAL colors Startup fee € 300 (ex. VAT)	<b>€ 4845</b> PIC007

## FLOOR FASTENING FEET

Outer dimensions (l x w x h): 147 x 95 x 75 cm









Structured powder coated aluminium + Stainless steel feet (4 pcs)

		<b>OFF WHITE</b> RAL9002	<b>€ 4800</b> PIC276
		<b>VERDIGRIS</b> RGB 133 147 142	<b>€ 4800</b> PIC022
		<b>COPPER BROWN</b> RAL8004	<b>€ 4800</b> PIC023
		<b>COBALT BLUE</b> RAL5013	<b>€ 5280</b> PIC024
		<b>SUN YELLOW</b> RAL1032	<b>€ 5280</b> PIC275
		<b>PISTACHE</b> RAL6021	<b>€ 5280</b> PIC277
		<b>ON REQUEST</b> Only RAL colors Startup fee € 300 (ex. VAT)	<b>€ 5040</b> PIC026

## PROTECTION FEET WITH FELT

Outer dimensions (l x w x h): 147 x 95 x 75 cm

Structured powder coated aluminium + Stainless steel feet with felt for delicate floors (6 pcs)

		<b>OFF WHITE</b> RAL9002	<b>€ 4855</b> PIC279
		<b>VERDIGRIS</b> RGB 133 147 142	<b>€ 4855</b> PIC030
		<b>COPPER BROWN</b> RAL8004	<b>€ 4855</b> PIC031
		<b>COBALT BLUE</b> RAL5013	<b>€ 5340</b> PIC032
		<b>SUN YELLOW</b> RAL1032	<b>€ 5340</b> PIC278
		<b>PISTACHE</b> RAL6021	<b>€ 5340</b> PIC280
		<b>ON REQUEST</b> Only RAL colors Startup fee € 300 (ex. VAT)	<b>€ 5100</b> PIC034

This freestanding shade opens horizontally like a hand fan and does not take up any space on your precious table. Thanks to its flat surface, Sensu offers excellent wind resistance while also keeping any technical parts out of sight. This floating shade opens and closes effortlessly while by cantilevering Sensu, you optimally cast the shade. The modular central pole can hold one, two, or even four shades for a maximum shade surface. Sensu is the perfect tool for enjoying a cool moment with friends and/or colleagues on a sunny day.









Check availability  
[www.extremis.com/portal](http://www.extremis.com/portal)

## SINGLE SQUARE - STRAIGHT

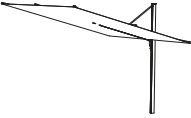
Outer dimensions (l x w x h): 323 x 300 x 250 cm | The shade itself is 300 x 300 cm  
 Acrylic fabric (cover included) + Structured powder coated aluminium pole (ø88 mm)  
 Always combine with one of the connection options on the next page  
 360 degree rotating system included

\* Leaving the collection. Available while supplies last

		 <b>WHITE</b> <i>Fabric</i>	 <b>TAUPE</b> <i>Fabric</i>	 <b>BLACK</b> <i>Fabric</i>
	 <b>PAPYRUS WHITE *</b> RAL9018	<b>€ 3850</b> SEN001	<b>€ 3850</b> SEN002	<b>€ 3850</b> SEN003
	 <b>OFF WHITE</b> RAL9002	<b>€ 3850</b> SEN178	<b>€ 3850</b> SEN179	<b>€ 3850</b> SEN180
	 <b>EARTH</b> RGB 88 88 84	<b>€ 3850</b> SEN006	<b>€ 3850</b> SEN005	<b>€ 3850</b> SEN004
	 <b>BLACK</b> RAL9005	<b>€ 3850</b> SEN007	<b>€ 3850</b> SEN008	<b>€ 3850</b> SEN009



### Friends of the product

**Hopper  
 combo**



→ p50

**Hopper  
 combo AA**



→ p51

**Marina  
 combo**



→ p86

**Marina  
 picnic**



→ p88

**Marina  
 table**



→ p94

**Marina  
 high table**



→ p96

**Panigiri combo,  
 picnic, table**



→ p102

**Walrus**









→ p156



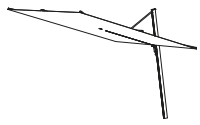

### SINGLE SQUARE - TILTED

Outer dimensions (l x w x h): 323 x 300 x 250 cm | The shade itself is 300 x 300 cm  
 Acrylic fabric (cover included) + Structured powder coated aluminium pole (ø88 mm)  
 Always combine with one of the connection options on the next page  
 360 degree rotating system included  
 The pole of the shade is leaning forward

		 <b>WHITE</b> <i>Fabric</i>	 <b>TAUPE</b> <i>Fabric</i>	 <b>BLACK</b> <i>Fabric</i>
	 <b>OFF WHITE</b> RAL9002	<b>€ 3850</b> SEN181	<b>€ 3850</b> SEN182	<b>€ 3850</b> SEN183
	 <b>EARTH</b> RGB 88 88 84	<b>€ 3850</b> SEN184	<b>€ 3850</b> SEN185	<b>€ 3850</b> SEN186
	 <b>BLACK</b> RAL9005	<b>€ 3850</b> SEN187	<b>€ 3850</b> SEN188	<b>€ 3850</b> SEN189

### STRAIGHT

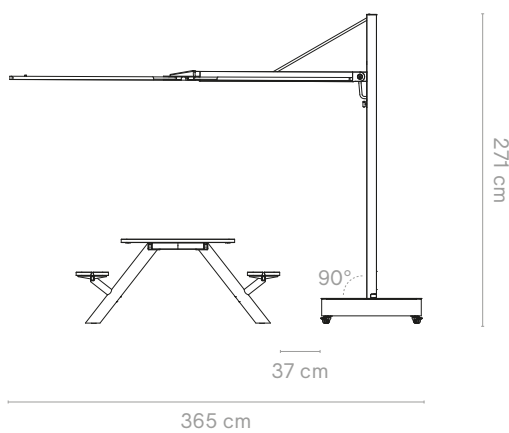

### TILTED

Creates more space between the base & table

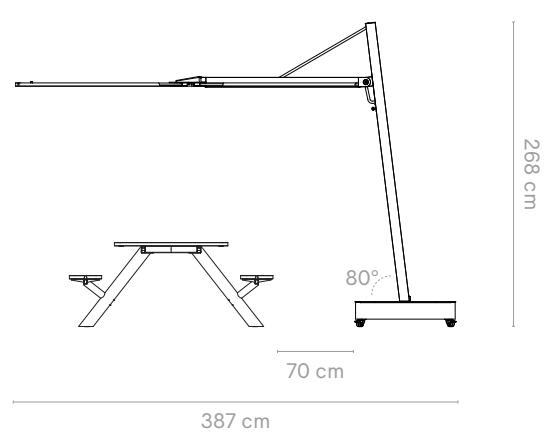

### Friends of the product

Panigiri  
 combo



→ p102

Panigiri  
 picnic



→ p102

Panigiri  
 table



→ p102





### WHEEL BASE - SINGLE STRAIGHT & TILTED

Outer dimensions (l x w x h): 88 x 88 x 22 cm

Structured powder coated aluminium | Weights not included

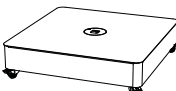
Only compatible with Sensu Single square straight & tilted

\* Leaving the collection. Available while supplies last

		<b>PAPYRUS WHITE *</b> RAL9018	<b>€ 1225</b> SEN068
		<b>OFF WHITE</b> RAL9002	<b>€ 1225</b> SEN190
		<b>EARTH</b> RGB 88 88 84	<b>€ 1225</b> SEN069
		<b>BLACK</b> RAL9005	<b>€ 1225</b> SEN067

### WEIGHTS

Tile set of concrete blocks for the base

	Concrete blocks 153 kg	<b>€ 250</b> SEN191
---	---------------------------	------------------------

### FLOOR FASTENING SPACER PLATE - SINGLE STRAIGHT & TILTED

Outer dimensions (ø x h): ø16 x 2 cm

To fix on solid ground

When using this, it is highly recommended to order a pole extension to increase the height by 15 cm to ensure head clearance

Only compatible with Sensu Single square straight & tilted

	HDPE - High density polyethylen Anchoring materials not included	<b>€ 105</b> SEN192
---	---	------------------------

### PERMANENT FIXATION - SINGLE STRAIGHT & TILTED

To fix in soft ground | Insert in concrete foundation | Anchoring materials not included

When using the permanent fixation, it is highly recommended to order a pole extension to increase the height by 15 cm to ensure head clearance

Only compatible with Sensu Single square straight & tilted

	Galvanized steel	<b>€ 275</b> SEN100
---	------------------	------------------------

### POLE EXTENSION - SINGLE STRAIGHT





Extends the pole of the shade with 15 cm

Galvanized steel connection piece with structured powder coated aluminium pole extension

When using the floor fastening spacer plate (SEN192) or permanent fixation (SEN100), it is highly recommended to order a pole extension to increase the height by 15 cm to ensure head clearance

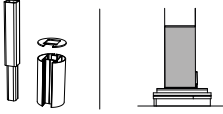
Only compatible with Sensu Single square straight

\* Leaving the collection. Available while supplies last

		<b>PAPYRUS WHITE *</b> RAL9018	<b>€ 140</b> SEN101
		<b>OFF WHITE</b> RAL9002	<b>€ #N/A</b> SEN193
		<b>EARTH</b> RGB 88 88 84	<b>€ 140</b> SEN106
		<b>BLACK</b> RAL9005	<b>€ 140</b> SEN107





### POLE EXTENSION - SINGLE TILTED

Extends the pole of the shade with 15 cm

Galvanized steel connection piece with structured powder coated aluminium pole extension

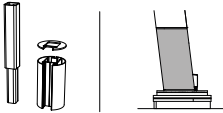
When using the floor fastening spacer plate (SEN192) or permanent fixation (SEN100), it is highly recommended to order a pole extension to increase the height by 15 cm to ensure head clearance

Only compatible with Sensu Single square tilted

		<b>OFF WHITE</b> RAL9002	<b>€ 140</b> SEN194
		<b>EARTH</b> RGB 88 88 84	<b>€ 140</b> SEN195
		<b>BLACK</b> RAL9005	<b>€ 140</b> SEN196





## DUO SQUARE

Outer dimensions (l x w x h): 640 x 300 x 250 cm | The shades itself are 300 x 300 cm

Acrylic fabric (cover included) + Structured powder coated aluminium pole (Pole ø114 mm)

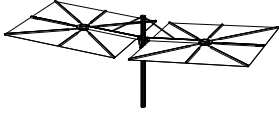
Always combine with one of the connection options on the next page - Can not be combined with the wheel base

\* Leaving the collection. Available while supplies last

		<b>PAPYRUS WHITE *</b> RAL9018 White fabric	<b>€ 6595</b> SEN016
		<b>EARTH</b> RGB 88 88 84 Taupe fabric	<b>€ 6595</b> SEN020
		<b>BLACK</b> RAL9005 Black fabric	<b>€ 6595</b> SEN024





## DUO DIAMOND

Outer dimensions (l x w x h): 526 x 270 x 250 cm | The shades itself are 250 x 250 cm

Acrylic fabric (cover included) + Structured powder coated aluminium pole (Pole ø114 mm)

Always combine with one of the connection options on the next page - Can not be combined with the wheel base

\* Leaving the collection. Available while supplies last

		<b>PAPYRUS WHITE *</b> RAL9018 White fabric	<b>€ 6185</b> SEN031
		<b>EARTH</b> RGB 88 88 84 Taupe fabric	<b>€ 6185</b> SEN035
		<b>BLACK</b> RAL9005 Black fabric	<b>€ 6185</b> SEN039





## QUATTRO DIAMOND

Outer dimensions (l x w x h): 526 x 526 x 250 cm | The shades itself are 250 x 250 cm

Acrylic fabric (cover included) + Structured powder coated aluminium pole (Pole ø114 mm)

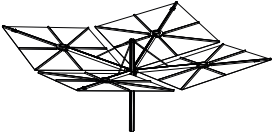
Always combine with one of the connection options on the next page - Can not be combined with the wheel base

\* Leaving the collection. Available while supplies last

		<b>PAPYRUS WHITE *</b> RAL9018 White fabric	<b>€ 11535</b> SEN046
		<b>EARTH</b> RGB 88 88 84 Taupe fabric	<b>€ 11535</b> SEN050
		<b>BLACK</b> RAL9005 Black fabric	<b>€ 11535</b> SEN054

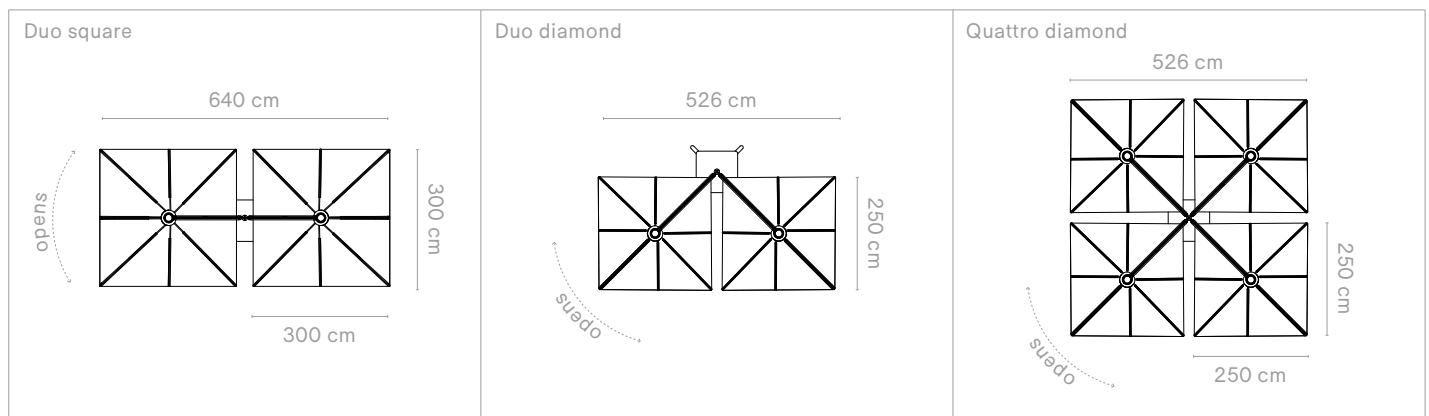





## BASE - DUO & QUATTRO

Outer dimensions (l x w x h): 113 x 113 x 16 cm

Structured powder coated aluminium cover plate + Stainless steel extension feet | Weights not included

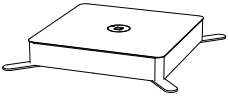
Only compatible with Sensu Duo square, Duo diamond & Quattro diamond

\* Leaving the collection. Available while supplies last

		<b>PAPYRUS WHITE *</b> RAL9018	<b>€ 1225</b> SEN071
		<b>EARTH</b> RGB 88 88 84	<b>€ 1225</b> SEN070
		<b>BLACK</b> RAL9005	<b>€ 1225</b> SEN072

## WEIGHTS

Tile set of concrete blocks for the base

	Concrete blocks 153 kg	<b>€ 250</b> SEN191
---	---------------------------	------------------------

## FLOOR FASTENING - DUO & QUATTRO

Outer dimensions (ø x h): ø21,5 x 0,8 cm

To fix on solid ground

When using the floor fastening, it is highly recommended to order a pole extension to increase the height by 15 cm to ensure head clearance

Only compatible with Sensu Duo square, Duo diamond & Quattro diamond

	Galvanized steel Anchoring materials not included	<b>€ 60</b> SEN097
---	--	-----------------------

## PERMANENT FIXATION - DUO & QUATTRO

To fix in soft ground | Insert in concrete foundation | Anchoring materials not included

When using the permanent fixation, it is highly recommended to order a pole extension to increase the height by 15 cm to ensure head clearance

Only compatible with Sensu Duo square, Duo diamond & Quattro diamond

	Galvanized steel	<b>€ 140</b> SEN055
---	------------------	------------------------



## POLE EXTENSION - DUO & QUATTRO

Extends the pole of the shade with 15 cm

Galvanized steel connection piece with structured powder coated aluminium pole extension | When using the permanent fixation (SEN055) or floor fastening (SEN097), it is highly recommended to order a pole extension to increase the height by 15 cm to ensure head clearance

Only compatible with Sensu Duo square, Duo diamond & Quattro diamond

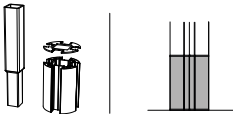
\* Leaving the collection. Available while supplies last

		<b>PAPYRUS WHITE *</b> RAL9018	<b>€ 190</b> SEN108
		<b>EARTH</b> RGB 88 88 84	<b>€ 190</b> SEN109
		<b>BLACK</b> RAL9005	<b>€ 190</b> SEN110

## SENSU COMBINATIONS

Single square straight - Single square tilted

Sensu single square straight +  
wheel base

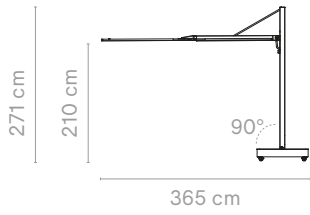

Sensu single square straight +  
permanent fixation

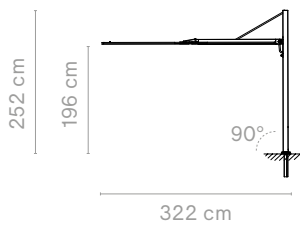

Sensu single square straight +  
permanent fixation & pole extension

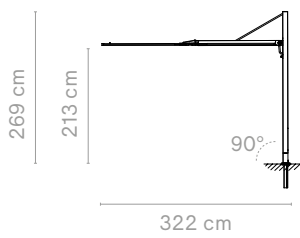

Sensu single square straight +  
floor fastening spacer plate & pole extension

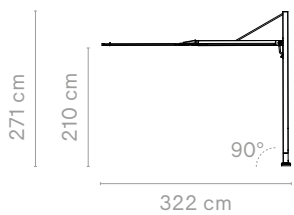

Sensu single square tilted +  
wheel base

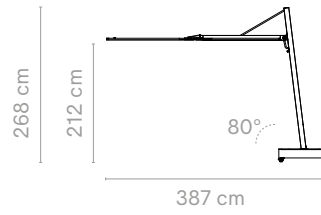

Sensu single square tilted +  
permanent fixation

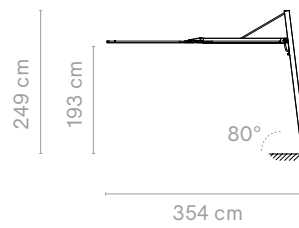

Sensu single square tilted +  
permanent fixation & pole extension

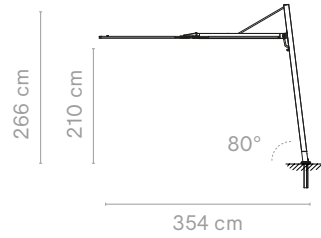

Sensu single square tilted +  
floor fastening spacer plate & pole extension

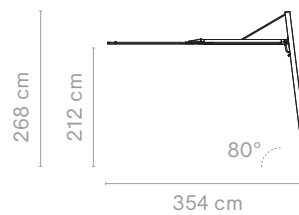

## SENSU COMBINATIONS

Duo square - Duo diamond - Quattro diamond

Sensu duo square +  
base

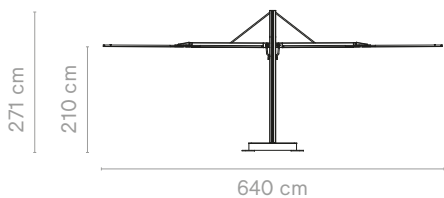

Sensu duo diamond +  
base

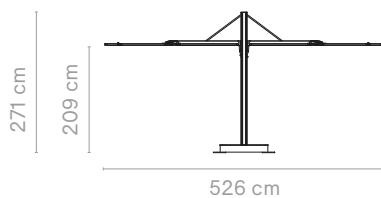

Sensu quattro diamond +  
base

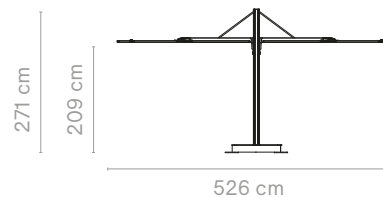

Sensu duo square +  
permanent fixation

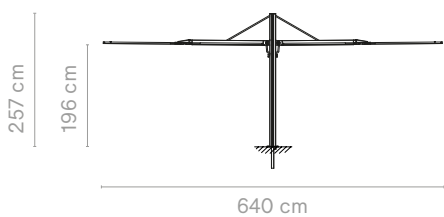

Sensu duo diamond +  
permanent fixation

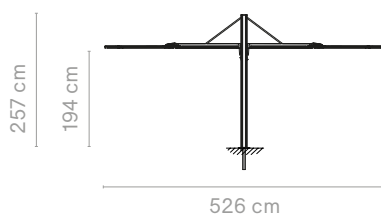

Sensu quattro diamond +  
permanent fixation

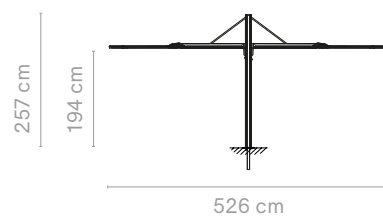

Sensu duo square +  
permanent fixation & pole extension

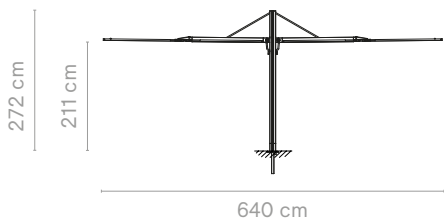

Sensu duo diamond +  
permanent fixation & pole extension

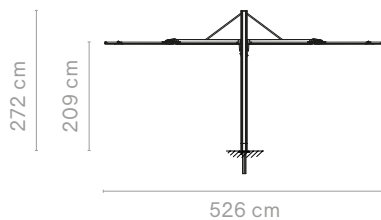

Sensu quattro diamond +  
permanent fixation & pole extension

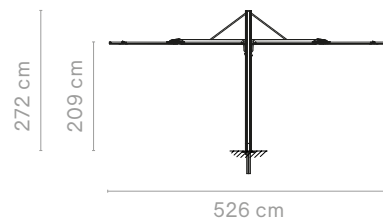

Sensu duo square +  
floor fastening

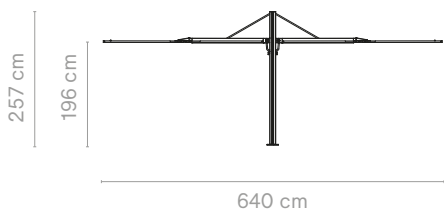

Sensu duo diamond +  
floor fastening

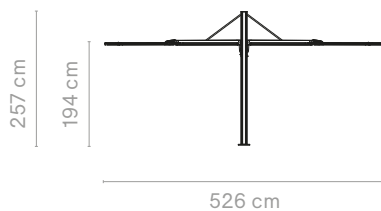

Sensu quattro diamond +  
floor fastening

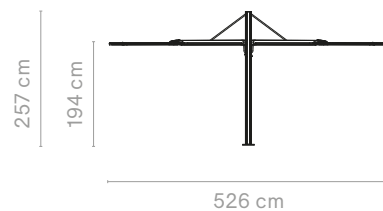

Sensu duo square +  
floor fastening & pole extension

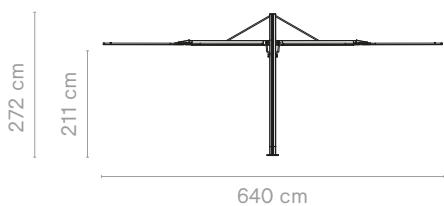

Sensu duo diamond +  
floor fastening & pole extension

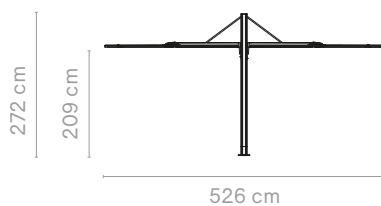

Sensu quattro diamond +  
floor fastening & pole extension

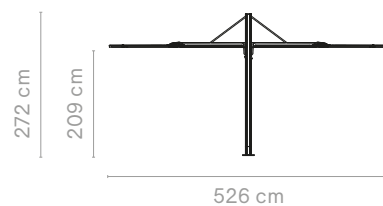

It's not a sunbed, it's not a sofa, it's both. Transform the comfortable outdoor lounge sofa into a sunbed. This multifunctionality makes Sol+Luna the perfect space-saving solution for balconies or patios. The slender sculptural frame and clean, architectural lines match the aesthetic of modern buildings, urban environments and boutique hotels. Accessories can be used to create shade, add lighting and provide surfaces for drinks. Storage accessories keep valuables safe while taking a dip in the pool.







Check availability  
[www.extremis.com/portal](http://www.extremis.com/portal)

## SOFA SUNBED

Outer dimensions (l x w x h): 210 x 77 x 60,5 / 35 cm

Structured powder coated aluminium frame & backrest + structured powder coated stainless steel legs + Batyline mesh

No cushions included

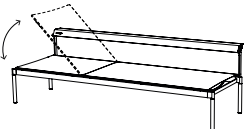

				
	<b>BLACK</b> RAL9005 <i>Batyline: Ebony</i>	<b>EARTH</b> RGB 88 88 84 <i>Batyline: Onyx</i>	<b>BEACH BEIGE</b> RAL1019 <i>Batyline: Snow</i>	<b>OFF WHITE</b> RAL9002 <i>Batyline: Snow</i>
	€ 2510 SOL006	€ 2510 SOL374	€ 2510 SOL452	€ 2510 SOL440

## TAPA TABLE

Outer dimensions (ø): 33 cm



HPL tabletop & Stainless steel support

Only compatible with the Sol+Luna plug-in system

		<b>WHITE</b> SOL009	€ 290
		<b>EARTH</b> SOL393	€ 290
		<b>BLACK</b> SOL010	€ 290

## WHEELS

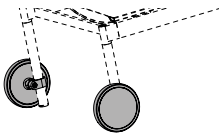
PU & powder coated aluminium cover plate

		<b>OFF WHITE</b> RAL9002	€ 245/set SOL065
		<b>BLACK</b> RAL9005	€ 245/set SOL053



### Friends of the product

Deco cushions

→ p40







## PLUG-IN SHADES

High tech polyester fabric + stainless steel tube + anodized aluminium handles | Fully adjustable

Only compatible with the Sol+Luna plug-in system | Cover included

Shade + Led: In countries where this type of plug is not used, a different plug will need to be fitted

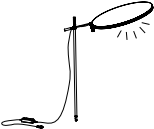







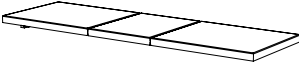

		<b>FLAT SHADE</b> ø 75 cm	<b>€ 695</b> SOL017
---	---	------------------------------	------------------------

		<b>SHADE + COOL WHITE LED</b> A type E / IP67 - 4500K / ø 70 cm	<b>€ 955</b> SOL018
		<b>SHADE + WARM WHITE LED</b> A type E / IP67 - 3000K / ø 70 cm	<b>€ 955</b> SOL019

## RECLINER + SEATING CUSHIONS

Outer dimensions (l x w x t): 200 x 63 x 5 cm









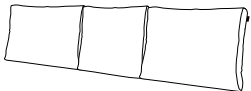

Please store the cushions inside when not in use

		<b>GREY CHINÉ</b> Sunbrella® Natté	<b>€ 420</b> SOL021
		<b>DARK TAUPE</b> Sunbrella® Natté	<b>€ 420</b> SOL020
		<b>COCONUT</b> Sunbrella® Savane	<b>€ 420</b> SOL403
		<b>MARBLE</b> Sunbrella® Lopi	<b>€ 540</b> SOL338
		<b>SOOTY ANTHRACITE</b> Sunbrella® Chartres	<b>€ 485</b> SOL024
		<b>MOSS</b> Sunbrella® Heritage	<b>€ 420</b> SOL454
		<b>COLOR ON REQUEST 1</b> Only for Sunbrella Natté, Solids, Savane & Heritage	<b>€ 445</b> SOL025
		<b>COLOR ON REQUEST 2</b> Only for Sunbrella Chartres	<b>€ 510</b> SOL346
		<b>COLOR ON REQUEST 3</b> Only for Sunbrella Lopi, Domino & Zori	<b>€ 565</b> SOL347

## COMFORT CUSHIONS

Outer dimensions (l x h x t)

Please store the cushions inside when not in use









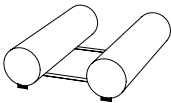

		 <b>SET OF 3 SEPARATE COMFORT CUSHIONS</b> <i>50 x 37 x 10 cm</i>	 <b>CONNECTED COMFORT CUSHIONS FOR 3 PEOPLE</b> <i>162 x 37 x 10 cm</i>
	<b>GREY CHINÉ</b> Sunbrella® Natté	<b>€ 440</b> SOL027	<b>€ 440</b> SOL033
	<b>DARK TAUPE</b> Sunbrella® Natté	<b>€ 440</b> SOL026	<b>€ 440</b> SOL032
	<b>COCONUT</b> Sunbrella® Savane	<b>€ 450</b> SOL404	<b>€ 440</b> SOL441
	<b>MARBLE</b> Sunbrella® Lopi	<b>€ 575</b> SOL341	<b>€ 575</b> SOL343
	<b>SOOTY ANTHRACITE</b> Sunbrella® Chartres	<b>€ 525</b> SOL030	<b>€ 525</b> SOL036
	<b>MOSS</b> Sunbrella® Heritage	<b>€ 440</b> SOL456	<b>€ 440</b> SOL455
	<b>COLOR ON REQUEST 1</b> Only for Sunbrella Natté, Solids, Savane & Heritage	<b>€ 465</b> SOL031	<b>€ 465</b> SOL037
	<b>COLOR ON REQUEST 2</b> Only for Sunbrella Chartres	<b>€ 550</b> SOL348	<b>€ 550</b> SOL350
	<b>COLOR ON REQUEST 3</b> Only for Sunbrella Lopi, Domino & Zori	<b>€ 600</b> SOL349	<b>€ 600</b> SOL351

## BOLSTER PILLOW SET

Outer dimensions: 55 x ø 13,5 cm

Can be connected to each other with a button

Please store the cushions inside when not in use

		<b>GREY CHINÉ</b> Sunbrella® Natté	<b>€ 280/set</b> SOL047
		<b>DARK TAUPE</b> Sunbrella® Natté	<b>€ 280/set</b> SOL046
		<b>COCONUT</b> Sunbrella® Savane	<b>€ 280/set</b> SOL405
		<b>MARBLE</b> Sunbrella® Lopi	<b>€ 360/set</b> SOL344
		<b>SOOTY ANTHRACITE</b> Sunbrella® Chartres	<b>€ 325/set</b> SOL050
		<b>MOSS</b> Sunbrella® Heritage	<b>€ 280/set</b> SOL457
		<b>COLOR ON REQUEST 1</b> Only for Sunbrella Natté, Solids, Savane & Heritage	<b>€ 305/set</b> SOL051
		<b>COLOR ON REQUEST 2</b> Only for Sunbrella Chartres	<b>€ 350/set</b> SOL352
		<b>COLOR ON REQUEST 3</b> Only for Sunbrella Lopi, Domino & Zori	<b>€ 385/set</b> SOL353

## COVER FOR SOFA SUNBED



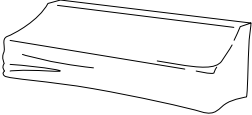

When not used for a long time - for instance during winter - we recommend storing the Sol+Luna with the cover and completely dry  
Suited for 2 stacked sofa sunbeds

	Grey PU coated polyester	<b>€ 320</b> SOL007
---	--------------------------	------------------------

## STORAGE OPTIONS

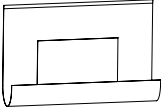
Outer dimensions (l x w)

Batylite mesh

		 <b>STORAGE NET</b> 75 x 41 cm	 <b>LOCKER</b> 36 x 32 cm
	<b>WHITE</b>	<b>€ 100</b> SOL013	<b>€ 135</b> SOL015
	<b>EARTH</b>	<b>€ 100</b> SOL378	<b>€ 135</b> SOL379
	<b>BLACK</b>	<b>€ 100</b> SOL014	<b>€ 135</b> SOL016

## POOL TOWEL

Use the bright yellow Extremis pool towel on your Sol+Luna sofa sunbed, it feels very soft.  
No more sliding towels, thanks to the flap that you can put over the headrest.

		<b>SUNNY YELLOW</b> 200 x 63 cm	<b>€ 50</b> SOL045
---	---	------------------------------------	-----------------------

**POPULAR FABRIC COMBINATIONS**

Numerous color combinations are possible  
 To make life easier, we have created several color combinations,  
 carefully composed following Extremis' color concepts.

Need any help finding the right color combination?  
 Go check our Biomes on page 175

**Out of the Fjordinary**  
*A boreal and montane togetherness biome*



Sol+Luna — **Black**



**Forest & Fields**  
*A green and rural togetherness biome*



Sol+Luna — **Off white**

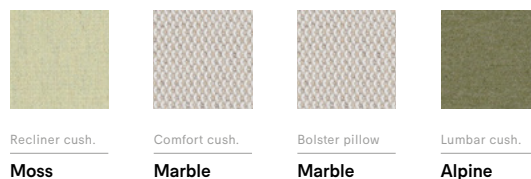

**A Lotta Terracotta**  
*A mediterranean togetherness biome*



Sol+Luna — **Earth**

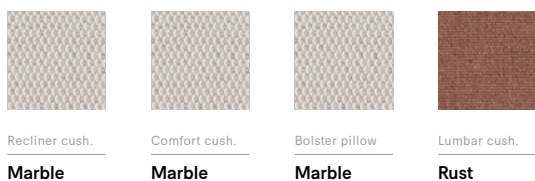

**Majestic Mirage**  
*A sandy and breezy togetherness biome*



Sol+Luna — **Beach beige**

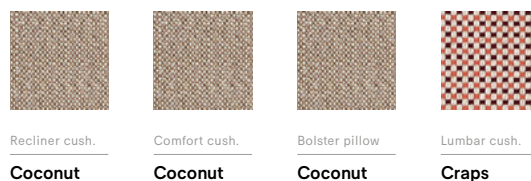

# Sticks

© design by Hsu-Li Teo & Stefan Kaiser

This space divider is ideal for creating a feeling of privacy in a garden or on a balcony without losing the sense of freedom typical of open spaces. Use Sticks indoors to adapt the look of a room or office arrangement entirely to your own taste. You can also choose which and how many rods you use and create various degrees of transparency, color combinations or differences in length. Delivered with optional feet for delicate floors. Rubber can cause stains on delicate surfaces. We recommend to use the feet if placed indoors. Use a wooden base on carpet floor.



Combine a base + rods to compose your favorite sticks.





Check availability  
[www.extremis.com/portal](http://www.extremis.com/portal)

## STANDARD BASES

Outer dimensions (l x w x h): 60 x 30 x 5 cm

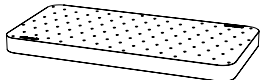
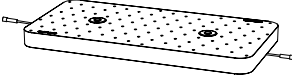

Choose rubber for outdoors/indoors or wood for indoors | Rods not included, choose rods on the next pages

		 RUBBER	 NATURAL WOOD	 DARK WOOD
	<b>STANDARD</b>	€ 175 STI076	€ 265 STI061	€ 320 STI043
	<b>COOL WHITE LEDS</b> IP65 - 6500K	€ 405 STI087	€ 495 STI075	€ 545 STI060
	<b>WARM WHITE LEDS</b> IP65 - 3000K	€ 405 STI085	€ 495 STI073	€ 545 STI058

## SHARP CURVED BASES

Outer dimensions (l x w x h): 65 x 33 x 5 cm - inner ø 2 m

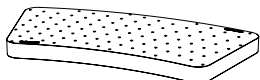
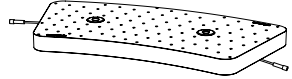

Choose rubber for outdoors/indoors or wood for indoors | Rods not included, choose rods on the next pages

		 RUBBER	 NATURAL WOOD	 DARK WOOD
	<b>STANDARD</b>	€ 205 STI077	€ 310 STI063	€ 360 STI046
	<b>COOL WHITE LEDS</b> IP65 - 6500K	€ 430 STI080	€ 530 STI067	€ 580 STI051
	<b>WARM WHITE LEDS</b> IP65 - 3000K	€ 430 STI078	€ 530 STI065	€ 580 STI048

### WIDE CURVED BASES

Outer dimensions (l x w x h): 63 x 32 x 5 cm - inner ø 4.30 m



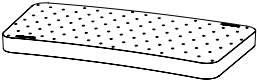
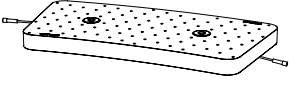
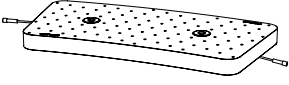

Choose rubber for outdoors/indoors or wood for indoors | Rods not included, choose rods on the next pages

		 RUBBER	 NATURAL WOOD	 DARK WOOD
	<b>STANDARD</b>	€ 205 STI081	€ 310 STI068	€ 360 STI053
	<b>COOL WHITE LED</b> IP65 - 6500K	€ 430 STI084	€ 530 STI072	€ 580 STI057
	<b>WARM WHITE LED</b> IP65 - 3000K	€ 430 STI082	€ 530 STI070	€ 580 STI055

### SQUARE BASES

Outer dimensions (l x w x h): 30 x 30 x 5 cm

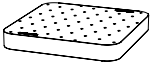
Choose rubber for outdoors/indoors. or wood for indoors | Rods not included, choose rods on the next pages

		 RUBBER	 NATURAL WOOD	 DARK WOOD
	<b>STANDARD</b>	€ 110 STI088	€ 155 STI092	€ 175 STI097
	<b>COOL WHITE LED</b> IP65 - 6500K	€ 215 STI089	€ 270 STI094	€ 290 STI099
	<b>WARM WHITE LED</b> IP65 - 3000K	€ 215 STI091	€ 270 STI096	€ 290 STI101

### MEDIUM BASE

Outer dimensions (l x w x h): 50 x 25 x 5 cm





Not suitable for windy spaces unless anchored to the floor | Rods not included, choose rods on the next pages

		<b>STANDARD</b> rubber	€ 150 STI102
---	---	---------------------------	-----------------

## RODS FOR STANDARD & CURVED BASES

Bases not included. Only sold with Extremis bases.



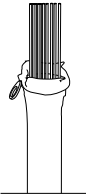

Because of the specific characteristics of the production process of fiberglass, colors can only be reproduced approximately and variations may occur. This is the case for both standard colors and custom request colors.

	 WHITE	 BLACK	 WOOD COLOR	 GREEN	 ON REQUEST <i>60 bases or more</i>	
	120 CM	€ 300 STI011	€ 330 STI039	€ 330 STI025	€ 330 STI112	€ 370 STI113
	150 CM	€ 350 STI012	€ 390 STI040	€ 390 STI026	€ 390 STI118	€ 420 STI121
	180 CM	€ 420 STI013	€ 460 STI041	€ 460 STI027	€ 460 STI119	€ 520 STI122
	210 CM	€ 470 STI014	€ 520 STI042	€ 520 STI028	€ 520 STI120	€ 600 STI123

## BIOPHILIC RODS FOR STANDARD & CURVED BASES

Bases not included. Only sold with Extremis bases.

Because of the specific characteristics of the production process of fiberglass, colors can only be reproduced approximately and variations may occur. This is the case for both standard colors and custom request colors.

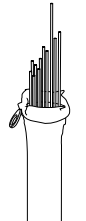
	 WHITE	 BLACK	 WOOD COLOR	 GREEN	
	120/ 210 CM	€ 420 STI280	€ 460 STI281	€ 460 STI282	€ 460 STI283

### STANDARD STICKS

All rods have the same height

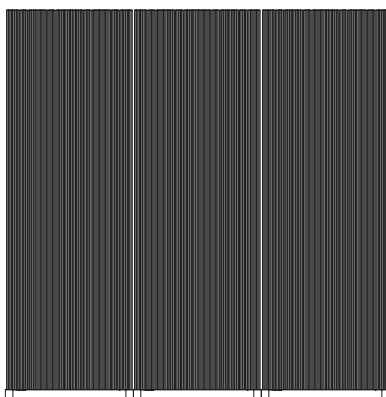

### BIOPHILIC STICKS

The rods vary in height between 120/150/180/210 cm

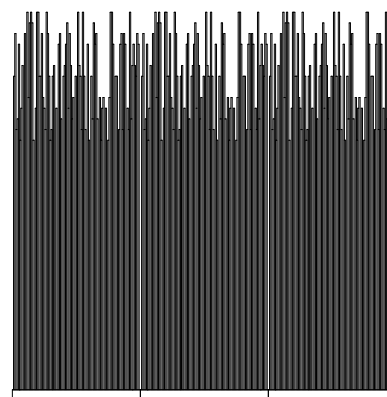







### RODS FOR SQUARE BASES

Bases not included. Only sold with Extremis bases.



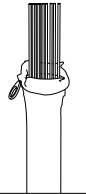

Because of the specific characteristics of the production process of fiberglass, colors can only be reproduced approximately and variations may occur. This is the case for both standard colors and custom request colors.

					 <b>ON REQUEST</b> <i>80 bases or more</i>	
	<b>120 CM</b>	<b>€ 150</b> STI004	<b>€ 165</b> STI032	<b>€ 165</b> STI018	<b>€ 165</b> STI114	<b>€ 185</b> STI124
	<b>150 CM</b>	<b>€ 175</b> STI005	<b>€ 195</b> STI033	<b>€ 195</b> STI019	<b>€ 195</b> STI115	<b>€ 210</b> STI125
	<b>180 CM</b>	<b>€ 210</b> STI006	<b>€ 230</b> STI034	<b>€ 230</b> STI020	<b>€ 230</b> STI116	<b>€ 260</b> STI126
	<b>210 CM</b>	<b>€ 235</b> STI007	<b>€ 260</b> STI035	<b>€ 260</b> STI021	<b>€ 260</b> STI117	<b>€ 300</b> STI127

### RODS FOR MEDIUM BASES

Bases not included. Only sold with Extremis bases.

Because of the specific characteristics of the production process of fiberglass, colors can only be reproduced approximately and variations may occur. This is the case for both standard colors and custom request colors.

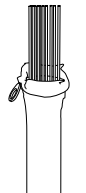
					 <b>ON REQUEST</b> <i>50 bases or more</i>	
	<b>120 CM</b>	<b>€ 200</b> STI008	<b>€ 230</b> STI036	<b>€ 230</b> STI022	<b>€ 230</b> STI128	<b>€ 250</b> STI134
	<b>150 CM</b>	<b>€ 250</b> STI009	<b>€ 260</b> STI037	<b>€ 260</b> STI023	<b>€ 260</b> STI132	<b>€ 280</b> STI135
	<b>180 CM</b>	<b>€ 280</b> STI010	<b>€ 310</b> STI038	<b>€ 310</b> STI024	<b>€ 310</b> STI133	<b>€ 330</b> STI136

## ELECTRICAL COMPONENTS

Cord length: 150 cm

In countries where this type of plug is not used, a different plug will need to be fitted

	<p><b>POWER SUPPLY + STOP</b> A type F / IP44 plug is supplied IP65 - Up to 9 bases can be connected</p>	<p><b>€ 140</b> ST1137</p>
--	--	--------------------------------

	<p><b>POWER SUPPLY WITH SWITCH + STOP</b> Indoor use only - A type F plug is supplied IP20 - Up to 9 bases can be connected</p>	<p><b>€ 165</b> ST1138</p>
--	---	--------------------------------

## OPTIONAL CONNECTION CABLES

To leave more space between the bases

The length of the cable has an impact on the number of bases that can be connected with 1 power supply

	<p><b>CONNECTION CABLE</b> IP65 - Up to 8 bases can be connected with 1 driver 100 cm</p>	<p><b>€ 10</b> ST1139</p>
	<p><b>L CONNECTION CABLE</b> IP65 - Up to 6 bases can be connected with 1 driver 400 cm</p>	<p><b>€ 20</b> ST1140</p>
	<p><b>XL CONNECTION CABLE</b> IP65 - Up to 4 bases can be connected with 1 driver 900 cm</p>	<p><b>€ 35</b> ST1141</p>

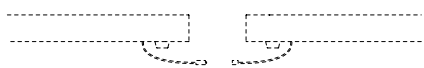

Standard connection cables  
(always included with bases with led)

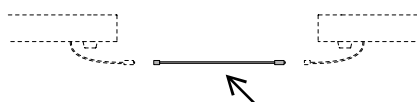

Optional connection cables  
(To leave more space between the bases)

## EXTRA WEIGHT

Galvanized steel, 1 piece

If floor fastening is not possible: extra weight for windy places

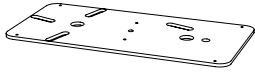

### FOR STANDARD BASES

10 kg/pc

€ 120

ST1159

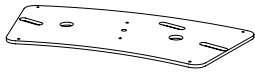

### FOR SHARP CURVED BASES

10 kg/pc

€ 130

ST1160

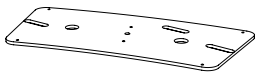

### FOR WIDE CURVED BASES

10 kg/pc

€ 140

ST1161

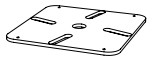

### FOR SQUARE BASES

5 kg/pc

€ 80

ST1162

## CONNECTION PIECE

Can not be combined with the medium base

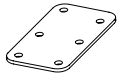

Stainless steel

10 x 6 cm

€ 20

ST1146

### WIDE CURVED BASES

24 pieces create a complete circle of  $\varnothing 4,30$  m

### SHARP CURVED BASES

12 pieces create a complete circle of  $\varnothing 2$  m

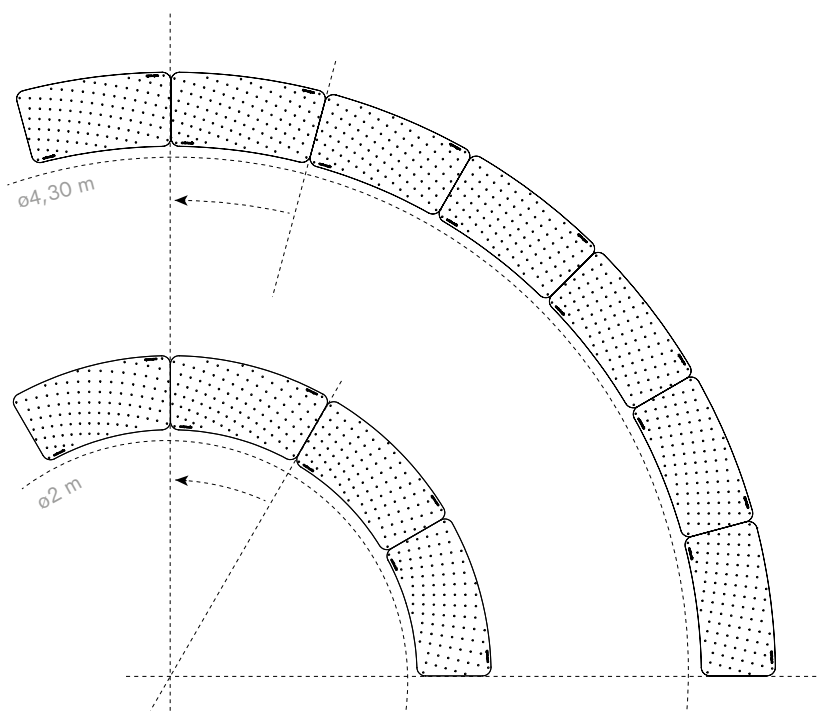

# Tiki stools

© design by Dirk Wynants

Tiki is the ideal stool for any party, indoors or outdoors. Or why not opt for a stylish twist, with a wooden seat? With its minimalist contours, this bar stool blends seamlessly in any setting, but also emphasizes the bar itself. Tiki offers comfortable seating and support for tired feet. Even with the optional backrest, your guests have optimal freedom of movement to move to the music while sitting down. And don't worry, the optional cushion won't be blown away by the wind, because it's safely attached to the seat. Tiki is your friend even when all furniture is moved aside to make space for the dance floor - simply stack it up (8 pieces)!



Check availability  
www.extremis.com/portal











Backrests → p144  
Protective feet → p144  
Cushions → p145

## LEGS + STRUCTURED POWDER COATED SEAT

Outer dimensions (l x w x h)

Structured powder coated zincated steel legs + Structured powder coated aluminium seat

Suitable for both indoor and outdoor use

				
		<b>STOOL</b> 39 x 41 x 45 cm	<b>COUNTER STOOL</b> 41 x 41 x 63 cm	<b>BAR STOOL</b> 41 x 41 x 74 cm
	<b>BLACK</b> RAL9005	€ 265 TIK030	€ 295 TIK036	€ 305 TIK042
	<b>EARTH</b> RGB 88 88 84	€ 265 TIK214	€ 295 TIK218	€ 305 TIK222
	<b>BEACH BEIGE</b> RAL1019	€ 265 TIK388	€ 295 TIK433	€ 305 TIK409
	<b>OFF WHITE</b> RAL9002	€ 265 TIK383	€ 295 TIK430	€ 305 TIK406
	<b>VERDIGRIS</b> RGB 133 147 142	€ 265 TIK213	€ 295 TIK217	€ 305 TIK221
	<b>REED GREEN</b> RAL6013	€ 265 TIK387	€ 295 TIK445	€ 305 TIK427



### Friends of the product

AMAI



→ p12

Marina  
high table



→ p96

Pantagruel  
high table



→ p114

Tiki table



→ p148











## LEGS + STRUCTURED POWDER COATED SEAT

Outer dimensions (l x w x h)

Structured powder coated zinc steel legs + Structured powder coated aluminium seat

Suitable for both indoor and outdoor use

	 <b>STOOL</b> 39 x 41 x 45 cm	 <b>COUNTER STOOL</b> 41 x 41 x 63 cm	 <b>BAR STOOL</b> 41 x 41 x 74 cm
 <b>COPPER BROWN</b> RAL8004	<b>€ 265</b> TIK326	<b>€ 295</b> TIK325	<b>€ 305</b> TIK074
 <b>COSMIC CREAM</b> RAL1015	<b>€ 265</b> TIK372	<b>€ 295</b> TIK394	<b>€ 305</b> TIK397
 <b>COBALT BLUE</b> RAL5013	<b>€ 290</b> TIK386	<b>€ 325</b> TIK439	<b>€ 335</b> TIK424
 <b>SUN YELLOW</b> RAL1032	<b>€ 290</b> TIK384	<b>€ 325</b> TIK436	<b>€ 335</b> TIK418
 <b>PISTACHE</b> RAL6021	<b>€ 290</b> TIK385	<b>€ 325</b> TIK442	<b>€ 335</b> TIK421
 <b>ON REQUEST</b> Only RAL colors Startup fee € 300 (ex. VAT)	<b>€ 275</b> TIK034	<b>€ 310</b> TIK040	<b>€ 320</b> TIK046











## LEGS + OILED OAK SEAT

Outer dimensions (l x w x h)

Structured powder coated zinced steel legs + Oiled oak seat

The oak seat is for indoor use only | Can not be combined with cushions

		 <b>STOOL</b> 39 x 41 x 45 cm	 <b>COUNTER STOOL</b> 41 x 41 x 63 cm	 <b>BAR STOOL</b> 41 x 41 x 74 cm
	<b>BLACK</b> RAL9005	€ 360 TIK031	€ 390 TIK037	€ 400 TIK043
	<b>EARTH</b> RGB 88 88 84	€ 360 TIK216	€ 390 TIK220	€ 400 TIK224
	<b>BEACH BEIGE</b> RAL1019	€ 360 TIK410	€ 390 TIK447	€ 400 TIK453
	<b>OFF WHITE</b> RAL9002	€ 360 TIK411	€ 390 TIK448	€ 400 TIK454
	<b>VERDIGRIS</b> RGB 133 147 142	€ 360 TIK215	€ 390 TIK219	€ 400 TIK223
	<b>REED GREEN</b> RAL6013	€ 360 TIK415	€ 390 TIK452	€ 400 TIK459











## LEGS + OILED OAK SEAT

Outer dimensions (l x w x h)

Structured powder coated zinc steel legs + Oiled oak seat











The oak seat is for indoor use only | Can not be combined with cushions

	 <b>STOOL</b> 39 x 41 x 45 cm	 <b>COUNTER STOOL</b> 41 x 41 x 63 cm	 <b>BAR STOOL</b> 41 x 41 x 74 cm
 <b>COPPER BROWN</b> RAL8004	<b>€ 360</b> TIK329	<b>€ 390</b> TIK328	<b>€ 400</b> TIK327
 <b>COSMIC CREAM</b> RAL1015	<b>€ 360</b> TIK391	<b>€ 390</b> TIK446	<b>€ 400</b> TIK455
 <b>COBALT BLUE</b> RAL5013	<b>€ 375</b> TIK414	<b>€ 410</b> TIK450	<b>€ 420</b> TIK457
 <b>SUN YELLOW</b> RAL1032	<b>€ 375</b> TIK412	<b>€ 410</b> TIK449	<b>€ 420</b> TIK456
 <b>PISTACHE</b> RAL6021	<b>€ 375</b> TIK413	<b>€ 410</b> TIK451	<b>€ 420</b> TIK458
 <b>ON REQUEST</b> Only RAL colors Startup fee € 300 (ex. VAT)	<b>€ 365</b> TIK035	<b>€ 400</b> TIK041	<b>€ 410</b> TIK047

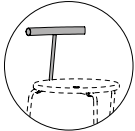
## BACKREST

Structured powder coated stainless steel | 1 piece

Suitable for both powder coated & oak seat

	<b>BLACK</b> RAL9005	<b>€ 120</b> TIK020
	<b>EARTH</b> RGB 88 88 84	<b>€ 120</b> TIK226
	<b>BEACH BEIGE</b> RAL1019	<b>€ 120</b> TIK401
	<b>OFF WHITE</b> RAL9002	<b>€ 120</b> TIK461
	<b>VERDIGRIS</b> RGB 133 147 142	<b>€ 120</b> TIK225
	<b>REED GREEN</b> RAL6013	<b>€ 120</b> TIK467
	<b>COPPER BROWN</b> RAL8004	<b>€ 120</b> TIK323
	<b>COSMIC CREAM</b> RAL1015	<b>€ 120</b> TIK403
	<b>COBALT BLUE</b> RAL5013	<b>€ 130</b> TIK463
	<b>SUN YELLOW</b> RAL1032	<b>€ 130</b> TIK402
	<b>PISTACHE</b> RAL6021	<b>€ 130</b> TIK465
	<b>COLOR ON REQUEST</b> Only RAL colors Startup fee € 300 (ex. VAT)	<b>€ 125</b> TIK022

## PROTECTION FEET WITH FELT

For delicate floors

Stacking is not recommended due the risk of damaging the powder coating









	<b>FELT</b> 1 set: 4 pieces	<b>€ 15/set</b> TIK189
---	--------------------------------	---------------------------



## CUSHIONS

Outer dimensions (ø x h): 34 x 1,5 cm - 1 piece

Please store the cushions inside when not in use

		<b>GREY CHINÉ</b> Sunbrella® Natté	<b>€ 95</b> VRS757
		<b>DARK TAUPE</b> Sunbrella® Natté	<b>€ 95</b> VRS758
		<b>MARBLE</b> Sunbrella® Lopi	<b>€ 115</b> VRS756
		<b>CHARCOAL</b> Sunbrella® Lopi	<b>€ 115</b> VRS755
		<b>LEAF GREEN</b> Sunbrella® Heritage	<b>€ 95</b> VRS761
		<b>INDIGO</b> Sunbrella® Heritage	<b>€ 95</b> VRS762
		<b>LOTO</b> Sunbrella® Domino	<b>€ 115</b> VRS760
		<b>CRAPS</b> Sunbrella® Domino	<b>€ 115</b> VRS759

## HOW TO COMBINE TIKI?

With AMAi, Panigiri & Tiki table

4 Tiki bar stools (powder coated seat) +  
AMAi catering station

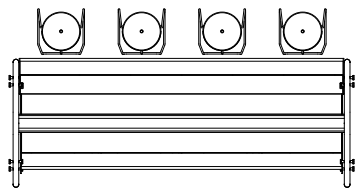

€ 7270

8 Tiki bar stools (powder coated seat) +  
AMAi standard (powder coated) & extension module +  
4 AMAi HiLo benches

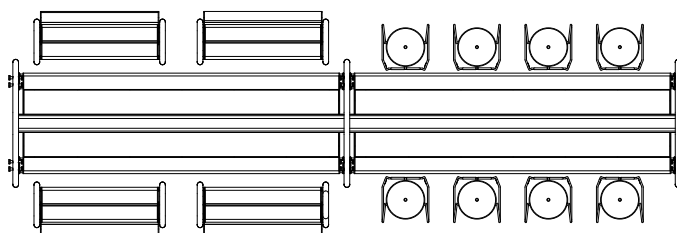

€ 17810

4 Tiki stools (powder coated seat) +  
Panigiri combo 326 cm

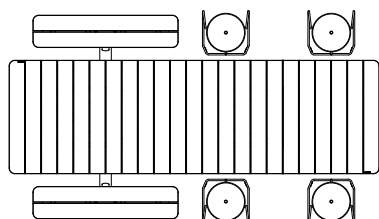

€ 8060

4 Tiki stools (powder coated seat) +  
Panigiri combo 326 cm + Panigiri additional picnic module

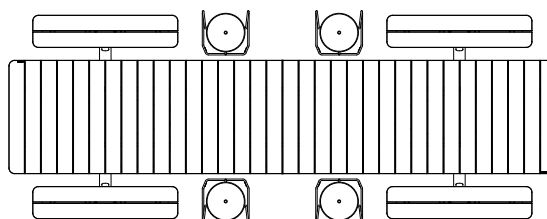

€ 12220

3 Tiki bar stools (powder coated seat) +  
Tiki table small

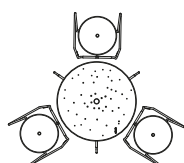

€ 1855

5 Tiki bar stools (powder coated seat) +  
Tiki table large

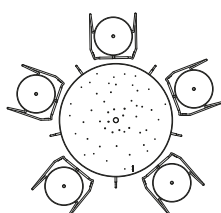

€ 2915

## HOW TO COMBINE TIKI?

With Marina high table & Pantagruel high table

4 Tiki bar stools (powder coated seat) +  
Marina high table 195 cm (5 profiles)

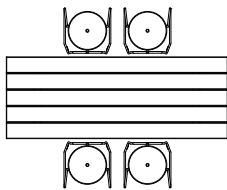

€ 3525

6 Tiki bar stools (powder coated seat) +  
Marina high table 265 cm (5 profiles)

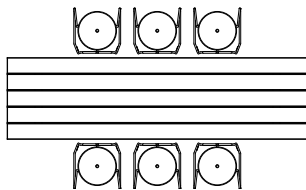

€ 4690

10 Tiki bar stools (powder coated seat) +  
Marina high table 335 cm (5 profiles)

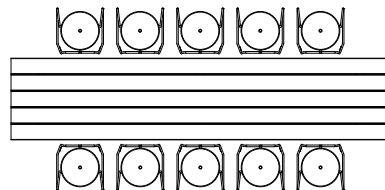

€ 6495

8 Tiki bar stools (powder coated seat) +  
Pantagruel high table (Hellwood)

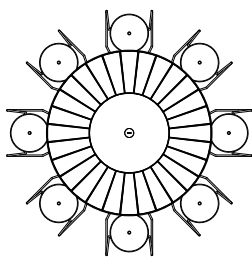

€ 6870

4 Tiki bar stools (powder coated seat) +  
4 Captain's Chairs high sliding + Pantagruel high table (Hellwood)

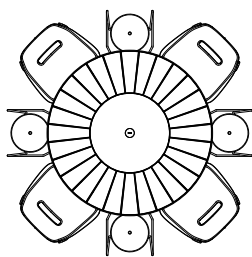

€ 7590

# Tiki table

© design by Dirk Wynants

Tiki table is sophisticated, weather-proof, functional, and ready to back your cocktail moment. Rest tired feet on the bent steel legs. The light, dainty aesthetic should not be underestimated as the durability of the design is ensured by a strong, wire-frame base made up of outdoor-resistant materials. But what really distinguishes this table is its foldable, compact design. Just take off the tabletop and fold in the legs when it's time to hit the dancefloor.



Check availability  
[www.extremis.com/portal](http://www.extremis.com/portal)











ø41 mm

## STANDARD TABLETOP WITH DRAINAGE HOLES & PARASOL HOLE

Outer dimensions (ø x h)

Structured powder coated ZnAlMg tabletop + structured powder coated zinced steel legs

		 <b>SMALL</b> ø92 x 105 cm Tabletop ø70 cm	 <b>LARGE</b> ø120 x 105 cm Tabletop ø100 cm
	<b>BLACK</b> RAL9005	€ 940 TIK263	€ 1390 TIK311
	<b>EARTH</b> RGB 88 88 84	€ 940 TIK300	€ 1390 TIK312
	<b>OFF WHITE</b> RAL9002	€ 940 TIK470	€ 1390 TIK473
	<b>VERDIGRIS</b> RGB 133 147 142	€ 940 TIK302	€ 1390 TIK314
	<b>COPPER BROWN</b> RAL8004	€ 940 TIK303	€ 1390 TIK315
	<b>COLOR ON REQUEST</b> Only RAL colors Startup fee € 300 (ex. VAT)	€ 1005 TIK304	€ 1435 TIK316



### Friends of the product

Acacia



→ p10

Tiki  
bar stool





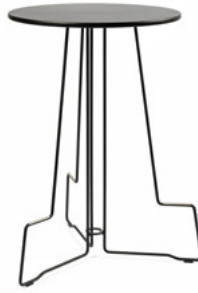





→ p140



### SOLID TABLETOP, NO PARASOL HOLE

Outer dimensions (ø x h)

Structured powder coated ZnAlMg tabletop + structured powder coated zinced steel legs

		 <b>SMALL</b> ø92 x 105 cm Tabletop ø70 cm	 <b>LARGE</b> ø120 x 105 cm Tabletop ø100 cm
	<b>BLACK</b> RAL9005	€ 940 TIK305	€ 1390 TIK317
	<b>EARTH</b> RGB 88 88 84	€ 940 TIK306	€ 1390 TIK318
	<b>OFF WHITE</b> RAL9002	€ 940 TIK476	€ 1390 TIK479
	<b>VERDIGRIS</b> RGB 133 147 142	€ 940 TIK308	€ 1390 TIK320
	<b>COPPER BROWN</b> RAL8004	€ 940 TIK309	€ 1390 TIK321
	<b>COLOR ON REQUEST</b> Only RAL colors Startup fee € 300 (ex. VAT)	€ 1005 TIK310	€ 1490 TIK322

### PROTECTION FEET WITH FELT

For delicate floors

	<b>FOR SMALL TABLE</b> 1 set: 3 pieces	<b>€ 10/set</b> TIK334
	<b>FOR LARGE TABLE</b> 1 set: 5 pieces	<b>€ 10/set</b> TIK335

Virus brings life to even the most sterile places. When you look at it from above, you can see its round shape with variously shaped arms. The compact design is an answer to smaller living spaces and makes it perfect to use on balconies, in urban gardens or in breakout spaces in offices or schools. There is a Virus picnic table fit for any need. Our aim? Togetherness, anywhere.



Add the included rubber ring to nicely fit your Acacia parasol.



Check availability  
www.extremis.com/portal



Wheelchair accessible  
→ p180



Backrests → p152  
Cushions → p153















ø41 mm

## STANDARD TABLETOP WITH DRAINAGE HOLES & PARASOL HOLE

Structured powder coated ZnAlMg tabletop, aluminium seats & stainless steel legs

Suitable for both outdoor and indoor use













			
	<b>3-SEATER</b> ø160 x 75 cm Tabletop ø80 cm	<b>4-SEATER</b> ø170 x 75 cm Tabletop ø90 cm	<b>5-SEATER</b> ø180 x 75 cm Tabletop ø100 cm
	<b>OFF WHITE</b> RAL9002 € 1635 VRS842	<b>€ 2020</b> VRS870	<b>€ 2415</b> VRS885
	<b>VERDIGRIS</b> RGB 133 147 142 € 1635 VRS019	<b>€ 2020</b> VRS018	<b>€ 2415</b> VRS017
	<b>REED GREEN</b> RAL6013 € 1635 VRS003	<b>€ 2020</b> VRS002	<b>€ 2415</b> VRS001
	<b>COPPER BROWN</b> RAL8004 € 1635 VRS027	<b>€ 2020</b> VRS026	<b>€ 2415</b> VRS025
	<b>COSMIC CREAM</b> RAL1015 € 1635 VRS856	<b>€ 2020</b> VRS872	<b>€ 2415</b> VRS887
	<b>COBALT BLUE</b> RAL5013 € 1800 VRS043	<b>€ 2230</b> VRS042	<b>€ 2670</b> VRS041
	<b>SUN YELLOW</b> RAL1032 € 1800 VRS855	<b>€ 2230</b> VRS871	<b>€ 2670</b> VRS886
	<b>PISTACHE</b> RAL6021 € 1800 VRS857	<b>€ 2230</b> VRS873	<b>€ 2670</b> VRS888
	<b>ON REQUEST</b> Only RAL colors Startup fee € 300 (ex. VAT) € 1710 VRS067	<b>€ 2115</b> VRS066	<b>€ 2530</b> VRS065



### SOLID TABLETOP, NO PARASOL HOLE











Structured powder coated ZnAlMg tabletop, aluminium seats & stainless steel legs

Suitable for both outdoor and indoor use

	 <b>3-SEATER</b> ø160 x 75 cm Tabletop ø80 cm	 <b>4-SEATER</b> ø170 x 75 cm Tabletop ø90 cm	 <b>5-SEATER</b> ø180 x 75 cm Tabletop ø100 cm
 <b>OFF WHITE</b> RAL9002	<b>€ 1615</b> VRS897	<b>€ 2000</b> VRS909	<b>€ 2390</b> VRS920
 <b>VERDIGRIS</b> RGB 133 147 142	<b>€ 1615</b> VRS528	<b>€ 2000</b> VRS529	<b>€ 2390</b> VRS530
 <b>REED GREEN</b> RAL6013	<b>€ 1615</b> VRS532	<b>€ 2000</b> VRS533	<b>€ 2390</b> VRS534
 <b>COPPER BROWN</b> RAL8004	<b>€ 1615</b> VRS536	<b>€ 2000</b> VRS537	<b>€ 2390</b> VRS538
 <b>COSMIC CREAM</b> RAL1015	<b>€ 1615</b> VRS899	<b>€ 2000</b> VRS911	<b>€ 2390</b> VRS922
 <b>COBALT BLUE</b> RAL5013	<b>€ 1780</b> VRS544	<b>€ 2205</b> VRS545	<b>€ 2640</b> VRS546
 <b>SUN YELLOW</b> RAL1032	<b>€ 1780</b> VRS898	<b>€ 2205</b> VRS910	<b>€ 2640</b> VRS921
 <b>PISTACHE</b> RAL6021	<b>€ 1780</b> VRS900	<b>€ 2205</b> VRS912	<b>€ 2640</b> VRS923
 <b>ON REQUEST</b> Only RAL colors Startup fee € 300 (ex. VAT)	<b>€ 1690</b> VRS556	<b>€ 2095</b> VRS557	<b>€ 2505</b> VRS558

## BACKRESTS

Structured powder coated zinc steel - 1 piece

		<b>OFF WHITE</b> RAL9002	<b>€ 175</b> VRS924
		<b>VERDIGRIS</b> RGB 133 147 142	<b>€ 175</b> VRS074
		<b>REED GREEN</b> RAL6013	<b>€ 175</b> VRS075
		<b>COPPER BROWN</b> RAL8004	<b>€ 175</b> VRS076
		<b>COSMIC CREAM</b> RAL1015	<b>€ 175</b> VRS926
		<b>COBALT BLUE</b> RAL5013	<b>€ 195</b> VRS078
		<b>SUN YELLOW</b> RAL1032	<b>€ 195</b> VRS925
		<b>PISTACHE</b> RAL6021	<b>€ 195</b> VRS927
	<b>COLOR ON REQUEST</b> Only RAL colors Startup fee € 300 (ex. VAT)	<b>€ 180</b> VRS081	

## FLOOR FASTENING

You need 1 piece for every seat

	Stainless steel	<b>€ 30/pc</b> VRS082
---	-----------------	--------------------------

## STACKING SPACER & PURSE HANGER

You need 1 piece for every leg

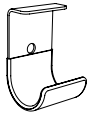
	Stainless steel with rubber cover	<b>€ 30/pc</b> VRS673
---	-----------------------------------	--------------------------



### Friends of the product

Acacia

→ p10













## CUSHIONS

Outer dimensions (ø x h): 34 x 1,5 cm - 1 piece

Please store the cushions inside when not in use

		<b>GREY CHINÉ</b> Sunbrella® Natté	<b>€ 95</b> VRS757
		<b>DARK TAUPE</b> Sunbrella® Natté	<b>€ 95</b> VRS758
		<b>MARBLE</b> Sunbrella® Lopi	<b>€ 115</b> VRS756
		<b>CHARCOAL</b> Sunbrella® Lopi	<b>€ 115</b> VRS755
		<b>LEAF GREEN</b> Sunbrella® Heritage	<b>€ 95</b> VRS761
		<b>INDIGO</b> Sunbrella® Heritage	<b>€ 95</b> VRS762
		<b>LOTO</b> Sunbrella® Domino	<b>€ 115</b> VRS760
		<b>CRAPS</b> Sunbrella® Domino	<b>€ 115</b> VRS759

### WIRELESS POWER - OUTDOOR & INDOOR

Outer dimensions (ø): 8 cm

Wireless charger on top, compatible with all devices with wireless charging system

It has a quick charge system | One battery included



2 x USB on battery pack  
Battery 55 wh - Antenna 5w  
IP65 & Shockproof

**€ 395**  
ELE001

### CHARGING TRAY FOR WIRELESS POWER

Outer dimensions (l x w x h): 24 x 8 x 9 cm

Charges up to four stations simultaneously in 7 hours | 4 charging slots

Includes magnetic key to remove the station from its support

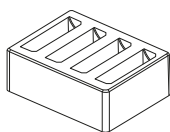

For Europe

**€ 280**  
ELE002

For United Kingdom

**€ 280**  
ELE003

For United States

**€ 280**  
ELE004

Wireless power

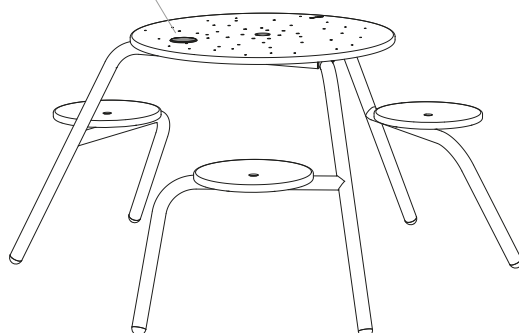

## VIRUS COMBINATIONS

With Acacia

Virus 3-seater (standard tabletop) +  
Acacia with lightweight parasol base



€ 3785

Virus 4-seater (standard tabletop) +  
Acacia with lightweight parasol base



€ 4170

Virus 5-seater (standard tabletop) +  
Acacia with lightweight parasol base

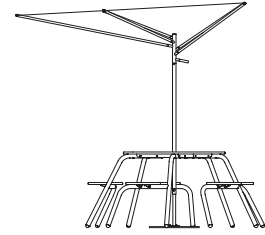

€ 4565

Walrus is a true innovation, as a super robust cover material is used to make a sleek, weatherproof sofa that always looks great. An ingenious storage pouch in the back of the Walrus hides a foldout blanket and cushions to provide softness and comfort. This softness is provided in a matter of seconds: a warm, dry and comfortable place to sit outdoors is instantly available as soon as the sun comes out. Yes, in all seasons! No blankets or comfort cushions pillowcase included.



Check availability  
[www.extremis.com/portal](http://www.extremis.com/portal)







Blankets → p160/161  
 Cushions → p162/163  
 Tables → p164  
 Feet → p164  
 Connection piece → p164

## MODULES WITH 110 CM WIDE SEATING

Outer dimensions (l x w x h) | Standard seating height: 32,5 cm

Morbern Sundance upholstery + galvanized steel frame & feet (standard galvanized feet are included)

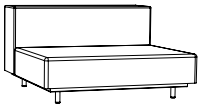
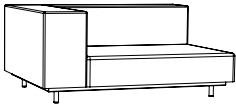
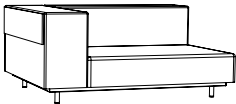
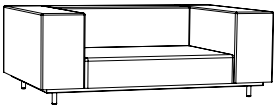
The backrest storage pouch always includes a comfort cushion filling, choose your pillowcase color on p 164/165

		 <b>CHALK</b>	 <b>SAFARI</b>	 <b>EARTH</b>
	<b>MIDDLE SEAT</b> With 1 storage pouch 110 x 110 x 60,5 cm	<b>€ 2245</b> WAL319	<b>€ 2245</b> WAL317	<b>€ 2245</b> WAL508
	<b>CORNER SEAT (L/R)</b> With 1 storage pouch 140 x 110 x 60,5 cm	<b>€ 3215</b> WAL314	<b>€ 3215</b> WAL315	<b>€ 3215</b> WAL509
	<b>CORNER SEAT (L/R) + EXTRA STORAGE POUCH</b> With 2 storage pouches 140 x 110 x 60,5 cm	<b>€ 3740</b> WAL320	<b>€ 3740</b> WAL321	<b>€ 3740</b> WAL510
	<b>CLUB CHAIR</b> With 1 storage pouch 170 x 110 x 60,5 cm	<b>€ 4195</b> WAL322	<b>€ 4195</b> WAL323	<b>€ 4195</b> WAL511
	<b>FOOTSTOOL</b> 110 x 80 x 32,5 cm	<b>€ 710</b> WAL324	<b>€ 710</b> WAL325	<b>€ 710</b> WAL512



### Friends of the product

Kosmos shade  
 square



→ p83

Sensu



→ p120





### MODULES WITH 80 CM WIDE SEATING

Outer dimensions (l x w x h) | Standard seating height: 32,5 cm

Morbern Sundance upholstery + galvanized steel frame & feet (standard galvanized feet are included)

The backrest storage pouch always includes a comfort cushion filling, choose your pillowcase color on p 164/165

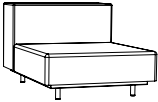
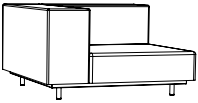
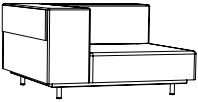
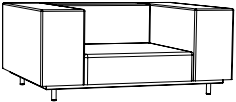
		 <b>CHALK</b>	 <b>SAFARI</b>	 <b>EARTH</b>
	<b>MIDDLE SEAT</b> With 1 storage pouch 80 x 110 x 60,5 cm	<b>€ 1705</b> WAL326	<b>€ 1705</b> WAL327	<b>€ 1705</b> WAL513
	<b>CORNER SEAT (L/R)</b> With 1 storage pouch 110 x 110 x 60,5 cm	<b>€ 2715</b> WAL318	<b>€ 2715</b> WAL316	<b>€ 2715</b> WAL514
	<b>CORNER SEAT (L/R) + EXTRA STORAGE POUCH</b> With 2 storage pouches 110 x 110 x 60,5 cm	<b>€ 3240</b> WAL328	<b>€ 3240</b> WAL329	<b>€ 3240</b> WAL515
	<b>CLUB CHAIR</b> With 1 storage pouch 140 x 110 x 60,5 cm	<b>€ 3685</b> WAL330	<b>€ 3685</b> WAL331	<b>€ 3685</b> WAL516















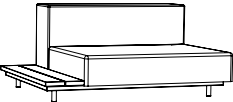

### SIDE TABLE MODULES WITH 110 CM WIDE SEATING

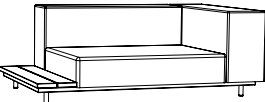
Outer dimensions (l x w x h) | Standard seating height: 32,5 cm

Morbern Sundance upholstery + galvanized steel frame & feet (standard galvanized feet are included)

The backrest storage pouch always includes a comfort cushion filling, choose your pillowcase color on p 164/165

Hellwood = 100% PEFC

				
		CHALK	SAFARI	EARTH
	  <p><b>SEAT WITH SIDE TABLE (L/R)</b> <b>HELLWOOD</b> With 1 storage pouch 137,5 x 110 x 60,5 cm</p>	<p>€ 2610 WAL334</p>	<p>€ 2610 WAL335</p>	<p>€ 2610 WAL518</p>
	 <p><b>SEAT WITH SIDE TABLE (L/R)</b> <b>IROKO</b> With 1 storage pouch 137,5 x 110 x 60,5 cm</p>	<p>€ 2685 WAL332</p>	<p>€ 2685 WAL333</p>	<p>€ 2685 WAL517</p>
	  <p><b>CORNER SEAT (L/R) + SIDE TABLE</b> <b>HELLWOOD</b> With 1 storage pouch 167,5 x 110 x 60,5 cm</p>	<p>€ 3590 WAL338</p>	<p>€ 3590 WAL339</p>	<p>€ 3590 WAL520</p>
	 <p><b>CORNER SEAT (L/R) + SIDE TABLE</b> <b>IROKO</b> With 1 storage pouch 167,5 x 110 x 60,5 cm</p>	<p>€ 3665 WAL336</p>	<p>€ 3665 WAL337</p>	<p>€ 3665 WAL519</p>
	  <p><b>SEAT WITH 2 SIDE TABLES</b> <b>HELLWOOD</b> With 1 storage pouch 165 x 110 x 60,5 cm</p>	<p>€ 2985 WAL342</p>	<p>€ 2985 WAL343</p>	<p>€ 2985 WAL522</p>
	 <p><b>SEAT WITH 2 SIDE TABLES</b> <b>IROKO</b> With 1 storage pouch 165 x 110 x 60,5 cm</p>	<p>€ 3135 WAL340</p>	<p>€ 3135 WAL341</p>	<p>€ 3135 WAL521</p>















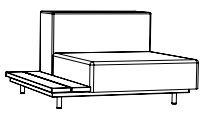

**SIDE TABLE MODULES WITH 80 CM WIDE SEATING**

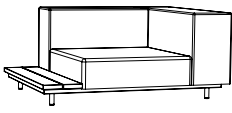
Outer dimensions (l x w x h) | Standard seating height: 32,5 cm

Morbern Sundance upholstery + galvanized steel frame & feet (standard galvanized feet are included)

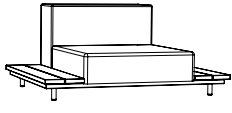
The backrest storage pouch always includes a comfort cushion filling, choose your pillowcase color on p 164/165

Hellwood = 100% PEFC

		 <b>CHALK</b>	 <b>SAFARI</b>	 <b>EARTH</b>	
	 	<b>SEAT WITH SIDE TABLE (L/R)</b> <b>HELLWOOD</b> With 1 storage pouch 107,5 x 110 x 60,5 cm	<b>€ 2110</b> WAL346	<b>€ 2110</b> WAL347	<b>€ 2110</b> WAL524
		<b>SEAT WITH SIDE TABLE (L/R)</b> <b>IROKO</b> With 1 storage pouch 107,5 x 110 x 60,5 cm	<b>€ 2185</b> WAL344	<b>€ 2185</b> WAL345	<b>€ 2185</b> WAL523
	 	<b>CORNER SEAT (L/R) + SIDE TABLE</b> <b>HELLWOOD</b> With 1 storage pouch 137,5 x 110 x 60,5 cm	<b>€ 3080</b> WAL350	<b>€ 3080</b> WAL351	<b>€ 3080</b> WAL526
		<b>CORNER SEAT (L/R) + SIDE TABLE</b> <b>IROKO</b> With 1 storage pouch 137,5 x 110 x 60,5 cm	<b>€ 3155</b> WAL348	<b>€ 3155</b> WAL349	<b>€ 3155</b> WAL525
	 	<b>SEAT WITH 2 SIDE TABLES</b> <b>HELLWOOD</b> With 1 storage pouch 135 x 110 x 60,5 cm	<b>€ 2495</b> WAL354	<b>€ 2495</b> WAL355	<b>€ 2495</b> WAL528
		<b>SEAT WITH 2 SIDE TABLES</b> <b>IROKO</b> With 1 storage pouch 135 x 110 x 60,5 cm	<b>€ 2645</b> WAL352	<b>€ 2645</b> WAL353	<b>€ 2645</b> WAL527





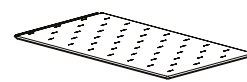
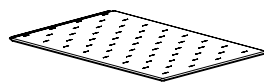

## BLANKETS

Outer dimensions (l x w x t)



**110 - BLANKET**  
157 x 105 x 2 cm  
For 110 cm seating







**80 - BLANKET**  
157 x 75 x 2 cm  
For 80 cm seating

	<b>GREY CHINÉ</b> Sunbrella® Natté	<b>€ 335</b> WAL075	<b>€ 275</b> WAL087
	<b>DARK TAUPE</b> Sunbrella® Natté	<b>€ 335</b> WAL074	<b>€ 275</b> WAL086
	<b>COCONUT</b> Sunbrella® Savane	<b>€ 335</b> WAL356	<b>€ 275</b> WAL363
	<b>MARBLE</b> Sunbrella® Lopi	<b>€ 455</b> WAL357	<b>€ 385</b> WAL364
	<b>CHARCOAL</b> Sunbrella® Lopi	<b>€ 455</b> WAL358	<b>€ 385</b> WAL365
	<b>SOOTY ANTHRACITE</b> Sunbrella® Chartres	<b>€ 395</b> WAL084	<b>€ 330</b> WAL096
	<b>LEAF GREEN</b> Sunbrella® Heritage	<b>€ 335</b> WAL083	<b>€ 275</b> WAL095

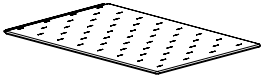
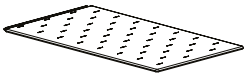

## BLANKETS













Outer dimensions (l x w x t)

		 <b>110 - BLANKET</b> <i>157 x 105 x 2 cm</i> <i>For 110 cm seating</i>	 <b>80 - BLANKET</b> <i>157 x 75 x 2 cm</i> <i>For 80 cm seating</i>
	<b>INDIGO</b> Sunbrella® Heritage	<b>€ 335</b> WAL362	<b>€ 275</b> WAL369
	<b>NAMI</b> Sunbrella® Zori	<b>€ 455</b> WAL436	<b>€ 385</b> WAL437
	<b>RUST</b> Sunbrella® Heritage	<b>€ 335</b> WAL361	<b>€ 275</b> WAL368
	<b>COLOR ON REQUEST 1</b> Only for Sunbrella Natté, Solids, Savane & Heritage	<b>€ 360</b> WAL085	<b>€ 300</b> WAL097
	<b>COLOR ON REQUEST 2</b> Only for Sunbrella Chartres	<b>€ 420</b> WAL432	<b>€ 355</b> WAL434
	<b>COLOR ON REQUEST 3</b> Only for Sunbrella Lopi, Domino & Zori	<b>€ 480</b> WAL433	<b>€ 410</b> WAL435

## CUSHIONS

Outer dimensions (l x w x t)

The filling of one comfort cushion is already included in the storage pouch of each module

					
		<b>110 - COMFORT CUSHION</b> <i>90 x 50 x 20 cm</i> <i>For 110 cm seating</i>	<b>80 - COMFORT CUSHION</b> <i>60 x 50 x 20 cm</i> <i>For 80 cm seating</i>	<b>LUMBAR CUSHION</b> <i>30 x 50 x 17 cm</i>	<b>DECO CUSHION</b> <i>50 x 50 x 17 cm</i>
	<b>GREY CHINÉ</b> Sunbrella® Natté	€ 180 WAL442	€ 120 WAL443	€ 75 WAL440	€ 100 WAL123
	<b>DARK TAUPE</b> Sunbrella® Natté	€ 180 WAL373	€ 120 WAL386	€ 75 WAL410	€ 100 WAL122
	<b>COCONUT</b> Sunbrella® Savane	€ 180 WAL370	€ 120 WAL383	€ 75 WAL407	€ 100 WAL394
	<b>MARBLE</b> Sunbrella® Lopi	€ 225 WAL371	€ 165 WAL384	€ 95 WAL408	€ 120 WAL395
	<b>CHARCOAL</b> Sunbrella® Lopi	€ 225 WAL372	€ 165 WAL385	€ 95 WAL409	€ 120 WAL396
	<b>SOOTY</b> Sunbrella® Chartres	€ 200 WAL444	€ 145 WAL445	€ 85 WAL441	€ 110 WAL132
	<b>LEAF GREEN</b> Sunbrella® Heritage	€ 180 WAL376	€ 120 WAL389	€ 75 WAL413	€ 100 WAL130
	<b>MOSS</b> Sunbrella® Heritage	/	/	€ 75 WAL415	€ 100 WAL400

## COMFORT CUSHION FILLING

Outer dimensions (l x w x t): 90 x 50 x 20 cm

Each Walrus module comes with one comfort cushion, included in its storage pouch. If you'd like to order an additional cushion, please remember to order an extra filling















	<b>110 - COMFORT CUSHION FILLING</b>	€ 50 WAL448
---	--------------------------------------	----------------

	<b>80 - COMFORT CUSHION FILLING</b>	€ 50 WAL449
---	-------------------------------------	----------------

## CUSHIONS

Outer dimensions (l x w x t)







The filling of one comfort cushion is already included in the storage pouch of each module

					
		<b>110 - COMFORT CUSHION</b> <i>90 x 50 x 20 cm</i> <i>For 110 cm seating</i>	<b>80 - COMFORT CUSHION</b> <i>60 x 50 x 20 cm</i> <i>For 80 cm seating</i>	<b>LUMBAR CUSHION</b> <i>30 x 50 x 17 cm</i>	<b>DECO CUSHION</b> <i>50 x 50 x 17 cm</i>
	<b>INDIGO</b> Sunbrella® Heritage	€ 180 WAL379	€ 120 WAL392	€ 75 WAL416	€ 100 WAL401
	<b>ALPINE</b> Sunbrella® Heritage	/	/	€ 75 WAL562	€ 100 WAL569
	<b>NAMI</b> Sunbrella® Zori	€ 225 WAL381	€ 165 WAL393	€ 95 WAL418	€ 120 WAL402
	<b>LOTO</b> Sunbrella® Domino	/	/	€ 95 WAL403	€ 120 WAL419
	<b>RUST</b> Sunbrella® Heritage	€ 180 WAL377	€ 120 WAL390	€ 75 WAL414	€ 100 WAL399
	<b>CRAPS</b> Sunbrella® Domino	/	/	€ 95 WAL404	€ 120 WAL420
	<b>BLUSH</b> Sunbrella® Solids	/	/	€ 75 WAL417	€ 100 WAL128
	<b>BISCUIT</b> Sunbrella® Lopi	/	/	€ 95 WAL564	€ 120 WAL563
	<b>COLOR ON REQUEST 1</b> Only for Sunbrella Natté, Solids, Savane & Heritage	€ 205 WAL446	€ 145 WAL447	€ 100 WAL423	€ 125 WAL133
	<b>COLOR ON REQUEST 2</b> Only for Sunbrella Chartres	€ 225 WAL430	€ 170 WAL428	€ 110 WAL424	€ 135 WAL426
	<b>COLOR ON REQUEST 3</b> Only for Sunbrella Lopi, Domino & Zori	€ 250 WAL431	€ 190 WAL429	€ 120 WAL425	€ 145 WAL427

## TABLES

Outer dimensions (l x w x h)



Galvanized steel frame (& legs) | Hellwood = 100% PEFC

		  <b>HELLWOOD</b> <i>Thermally treated wood tabletop</i>	 <b>IROKO</b> <i>Tropical hardwood tabletop</i>
	<b>COFFEE TABLE</b> 110 x 82 x 13,5 cm	<b>€ 1045</b> WAL065	<b>€ 1075</b> WAL064
	<b>CORNER SQUARE TABLE</b> 110 x 110 x 13,5 cm	<b>€ 1320</b> WAL067	<b>€ 1360</b> WAL066
	<b>LINKING TABLE</b> 110 x 75 x 13,5 cm	<b>€ 800</b> WAL069	<b>€ 825</b> WAL068

## FEET

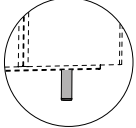
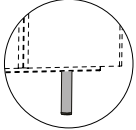

Galvanized steel or Structured powder coated steel

1 set of 4 feet per module

		 <b>GALVANIZED STEEL</b>	 <b>ANTHRACITE</b> <i>RAL7016</i>
	<b>FEET</b> Seating height: 32,5 cm	<b>€ incl.</b>	<b>€ 15/set</b> WAL071
	<b>HIGH FEET</b> Seating height: 37,5 cm	<b>€ 60/set</b> WAL072	<b>€ 70/set</b> WAL073

## CONNECTION PIECE

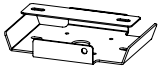
Attach two frames together

		Galvanized steel 23 x 17 x 3,3 cm	<b>€ 50</b> WAL158
---	---	--------------------------------------	-----------------------

**POPULAR FABRIC COMBINATIONS**

Numerous color combinations are possible  
 To make life easier, we have created several color combinations,  
 carefully composed following Extremis' color concepts.

Need any help finding the right color combination?  
 Go check our Biomes on page 175

**Out of the Fjordinary**  
*A boreal and montane togetherness biome*



Walrus base color — **Chalk**

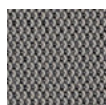

Blanket  
**Charcoal**

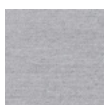

Comfort cush.  
**Grey chiné**

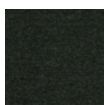

Lumbar cush.  
**Alpine**

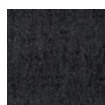

Deco cush.  
**Sooty**

**Forest & Fields**  
*A green and rural togetherness biome*



Walrus base color — **Earth**



Blanket  
**Coconut**



Comfort cush.  
**Marble**

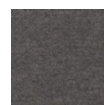

Lumbar cush.  
**Dark taupe**



Deco cush.  
**Leaf green**

**A Lotta Terracotta**  
*A mediterranean togetherness biome*



Walrus base color — **Safari**



Blanket  
**Coconut**

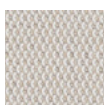

Comfort cush.  
**Marble**

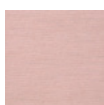

Lumbar cush.  
**Blush**

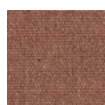

Deco cush.  
**Rust**

**Majestic Mirage**  
*A sandy and breezy togetherness biome*



Walrus base color — **Safari**

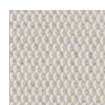

Blanket  
**Marble**

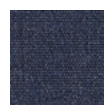

Comfort cush.  
**Indigo**

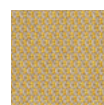

Lumbar cush.  
**Biscuit**



Deco cush.  
**Loto**

## WALRUS COMBINATIONS

Some predefined combinations, connection piece(s) are included in the price samples below

Blankets & cushions are included in the price samples below

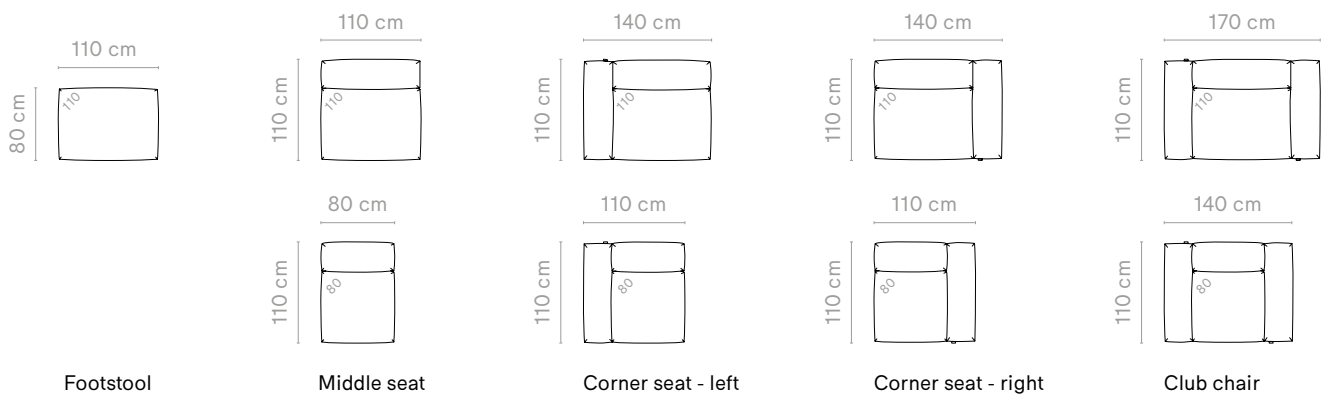

## WALRUS DOUBLE TROUBLE

Walrus base - Chalk + Out of the Fjordinary cushion set

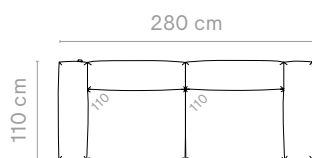

## WALRUS LOVELY LOUNGER

Walrus base - Earth + Forest & Fields cushion set

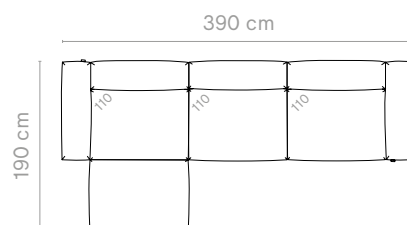

WAL314 (x2) + WAL158 + WAL358 (x2) + WAL371 (x2) +  
WAL132 (x2) + WAL562 (x2)

€ 8230

WAL509 (x2) + WAL508 + WAL158 (x2) + WAL356 (x3) +  
WAL371 (x3) + WAL130 (x3) + WAL410 (x3)

€ 10980

## WALRUS COMBINATIONS

Some predefined combinations, connection piece(s) are included in the price samples below

Blankets & cushions are included in the price samples below

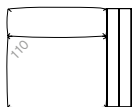
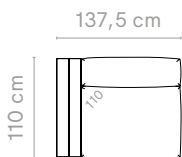

Seat with side table

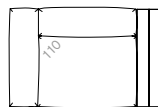
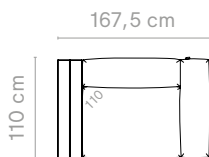

Seat with armrest & side table

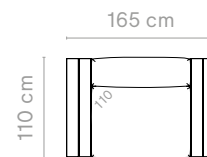

Seat with 2 side tables

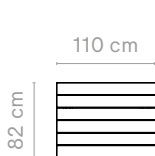
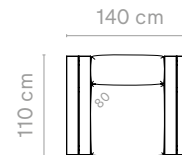
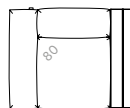
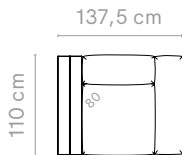
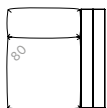
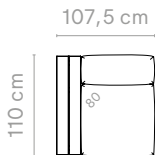

Coffee table

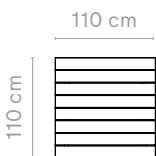

Corner table

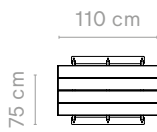

Linking table

## WALRUS MEET THE PARENTS

Walrus base - Safari + Majestic Mirage cushion set

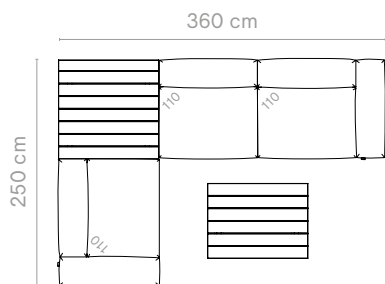

## WALRUS MAJESTIC MONDO

Walrus base - Safari + A Lotta Terracotta cushion set

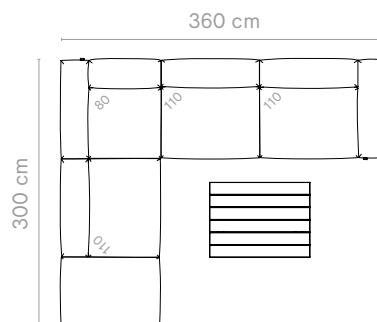

WAL315 (x2) + WAL317 + WAL158 + WAL357 (x3) + WAL379 (x3) + WAL419 (x3) + WAL564 (x3) + WAL064 + WAL066

€ 13710

WAL315 + WAL317 (x2) + WAL316 + WAL325 + WAL158 (x3) + WAL356 (x3) + WAL363 + WAL371 (x3) + WAL384 + WAL399 (x4) + WAL417 (x4) + WAL064

€ 15175

# Finishes

---

Generally speaking, aluminum and steel are low-maintenance materials. Thanks to powder coating techniques, these materials are available in several colors. Choose white only if you are willing to take greater care and clean your products regularly. If you are not big on cleaning you should consider galvanized steel for your furniture.

Galvanized steel

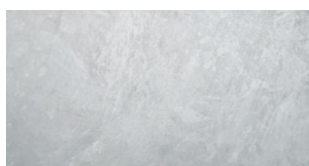

Black — RAL9005



Earth — RGB 88 88 84

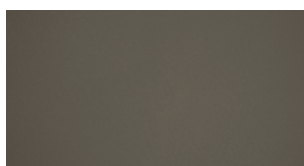

Beach beige — RAL1019

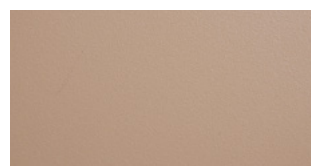

Off white — RAL9002

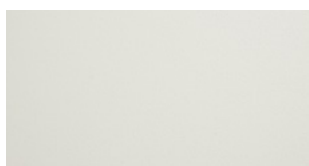

White — RAL9016

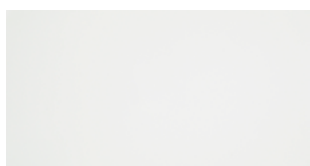

Papyrus white — RAL9018



Verdigris — RGB 133 147 142

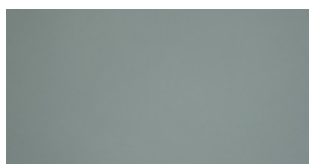

Reed green — RAL6013

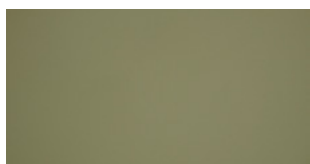

Copper brown — RAL8004

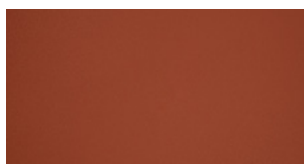

Cosmic cream — RAL1015

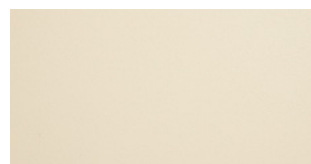

Cobalt blue — RAL5013



Sun yellow — RAL1032



Pistache — RAL6021

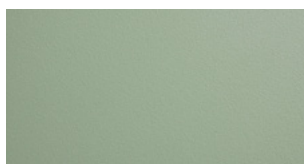



# Sunbrella®

---

Sunbrella® is an acrylic fabric that is still known as the best outdoor fabric available for making cushions. The raw material is Sunbrella® solution-dyed acrylic fibre. The color pigments are locked right into the very heart of the fibres during the initial stage of the manufacturing process, before the yarn is even made. Sunbrella® colors stand up to tough weather conditions and years of sun exposure.

Grey chiné — Natté



Dark taupe — Natté

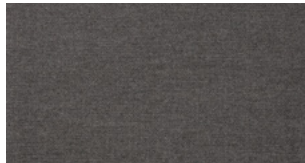

Coconut — Savane



Marble — Lopi



Charcoal — Lopi



Sooty — Chartres

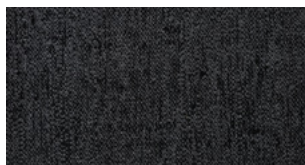

Leaf green — Heritage



Moss — Heritage



Alpine — Heritage

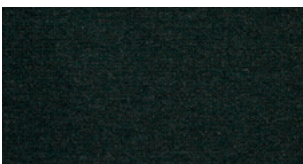

Indigo — Heritage

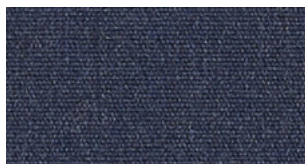

Nami — Zori



Loto — Domino



Rust — Heritage

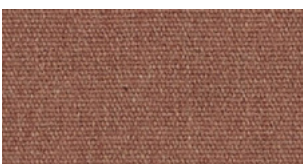

Craps — Domino



Blush — Solids

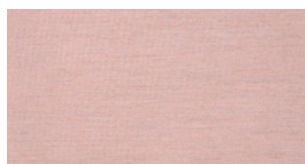



































































































Biscuit — Lopi



# Finishes

Easily navigate through this color matrix for finishes to discover which colors are available for each product.

	Acacia 	AMAI 	Anker 	Bistroo 	Captain's Chair shell 	Captain's sliding legs 	Captain's High Sliding legs 	Captain's Pipe legs 	Hopper bench 	Hopper bench AA 	Hopper combo 	Hopper combo AA 	Hopper picnic 
Galvanized STEEL													
Black RAL9005													
Earth RGB 88 88 84													
Beach beige RAL1019													
Off white RAL9002													
White* RAL9016													
Papyrus white* RAL9018													
Verdigris RGB 133 147 142													
Reed green RAL6013													
Copper brown RAL8004													
Cosmic cream RAL1015													
Cobalt blue RAL5013													
Sun yellow RAL1032													
Pistache RAL6021													

\* Leaving the collection. Available while supplies last.

	Hopper picnic AA	Inumbra	Kosmos	Manille	Marina	Panigiri	Pantagruel	Picnik	Sensu single straight	Sensu single tilted	Sensu duo & quattro	Sol+Luna	Tiki stools	Tiki table	Virus
							●								
●	●	●				●	●		●	●	●	●	●	●	
●		●	●			●	●		●	●	●	●	●	●	
●						●	●					●	●		
●		●			●	●	●	●	●	●		●	●	●	●
									●		●				
●					●			●					●	●	●
●					●								●		●
●				●	●			●					●	●	●
				●									●		●
								●					●		●
								●					●		●
				●				●					●		●

# Sunbrella®

Explore our Sunbrella color matrix for a quick and easy way to identify the available colors for each product.

	AMAI HiLo bench	Bistroo	Captain's Chair	Deco cushions	Gargantua	Hopper	Kosmos	Marina	Panigiri	Pantagruel	Sol+Luna	Tiki	Virus	Walrus
Grey chiné NATTÉ														
Dark taupe NATTÉ														
Coconut SAVANE														
Marble LOPI														
Charcoal LOPI														
Sooty CHARTRES														
Leaf green HERITAGE														
Moss HERITAGE														
Indigo HERITAGE														
Alpine HERITAGE														
Nami ZORI														
Loto DOMINO														
Rust HERITAGE														
Craps DOMINO														
Blush SOLIDS														
Biscuit LOPI														

# Biomes

Biomes are the large vegetation zones of the earth. Each biome undeniably evokes a certain atmosphere. We drew on them to design color palettes in order to make it easier to combine our products and cushions.

## Out of the Fjordinary

*A boreal and montane togetherness biome*

*We translated the northern biomes into a balanced color palette, transcending the ordinary through a blend of nature's most incredible beauty*

Powder coating colors

Sunbrella fabric colors

<ol style="list-style-type: none"> <li>1. Black</li> <li>2. Off white</li> <li>3. Cobalt blue</li> <li>4. Pistache</li> <li>5. Verdigris</li> </ol>	<ol style="list-style-type: none"> <li>6. Sooty</li> <li>7. Charcoal</li> </ol>	<ol style="list-style-type: none"> <li>1. Grey chiné</li> <li>2. Moss</li> <li>3. Alpine</li> <li>4. Indigo</li> <li>5. Nami</li> <li>6. Sooty</li> <li>7. Charcoal</li> </ol>
---	---	--

## Forest & Fields

*A green and rural togetherness biome*

*Rooted in West-Flemish tradition, we blend temperate forest elements - the main European biome - with local clay and hay for a unique touch*

Powder coating colors

Sunbrella fabric colors

<ol style="list-style-type: none"> <li>1. Black</li> <li>2. Verdigris</li> <li>3. Reed green</li> <li>4. Earth</li> <li>5. Off white</li> </ol>	<ol style="list-style-type: none"> <li>6. Sooty</li> <li>7. Charcoal</li> </ol>	<ol style="list-style-type: none"> <li>1. Marble</li> <li>2. Coconut</li> <li>3. Biscuit</li> <li>4. Moss</li> <li>5. Leaf green</li> <li>6. Sooty</li> <li>7. Dark taupe</li> </ol>
---	---	--

## A Lotta Terracotta

*A mediterranean togetherness biome*

*Welcome to warm earthy tones and terracotta red shores: this is just the perfect holiday color palette*

Powder coating colors

Sunbrella fabric colors

<ol style="list-style-type: none"> <li>1. Beach beige</li> <li>2. Cosmic cream</li> <li>3. Copper brown</li> <li>4. Earth</li> <li>5. Off white</li> </ol>	<ol style="list-style-type: none"> <li>6. Indigo</li> <li>7. Dark taupe</li> </ol>	<ol style="list-style-type: none"> <li>1. Marble</li> <li>2. Biscuit</li> <li>3. Coconut</li> <li>4. Blush</li> <li>5. Rust</li> <li>6. Indigo</li> <li>7. Dark taupe</li> </ol>
--	--	--

## Majestic Mirage

*A sandy and breezy togetherness biome*

*Embark on a captivating nighttime escapade where gentle hues of yellows and rich accents cast a mesmerizing allure over the dunes*

Powder coating colors

Sunbrella fabric colors

<ol style="list-style-type: none"> <li>1. Off white</li> <li>2. Sun yellow</li> <li>3. Cosmic cream</li> <li>4. Cobalt blue</li> <li>5. Beach beige</li> </ol>	<ol style="list-style-type: none"> <li>6. Indigo</li> <li>7. Dark taupe</li> </ol>	<ol style="list-style-type: none"> <li>1. Marble</li> <li>2. Coconut</li> <li>3. Craps</li> <li>4. Biscuit</li> <li>5. Indigo</li> <li>6. Loto</li> </ol>
--	--	---

# Professionals

---

Professionals, we've got you covered! Whether you're an architect, designer, or a pro in the world of landscape, office, education, or hospitality, we've got the tools you need to make your projects shine with Extremis.

[www.extremis.com/pro](http://www.extremis.com/pro)

## CUSTOM COLORS

We believe that color has the power to elevate the esthetic appeal of any project, allowing for harmonious integration within various environments. Whether it's a vibrant hue that captures attention or a subtle tone that complements the surrounding elements. That's why most of our products are available in any RAL-color you want.

Startup fee of € 300 (ex. VAT) per color.



## FLOOR FASTENING

Through innovative engineering and meticulous attention to detail, we ensure that our furniture remains securely anchored to the ground. This offers peace of mind to both designers and end users, knowing that our anchoring systems not only deter theft but also prevent the furniture from being dislodged or blown away by strong winds.

However, it's important to note that the installation of our products should be done by qualified individuals. The anchoring process involves using suitable bolts or screws, which can be obtained from a specialized store. The selection of these components greatly depends on the material your terrace is made of. This ensures that the anchoring is not just secure, but also perfectly suited to your specific environment.

## DOWNLOADS

Get the complete packages of all technical and inspirational materials from a single destination: [www.extremis.com/en/product-downloads](http://www.extremis.com/en/product-downloads)

- Product pictures
- 2D & 3D files (2d dwg, 3d dwg, sketchup, revit, 3d max, 3ds max)
- Product factsheets
- Spec sheets
- Manuals



## CONFIGURATOR

Showrooms, pictures, samples, we have it all. But what is the dream terrace your client is looking for? You don't need a magic wand to get inside their heads. With our configurator, you customize their favorite pieces in a snap. Size, colors, materials - a computer or a phone will do!

Found the perfect match? Show your clients what it might look like in their own space! The augmented reality feature makes our pieces more tangible than ever!

[www.extremis.com/configurator](http://www.extremis.com/configurator)

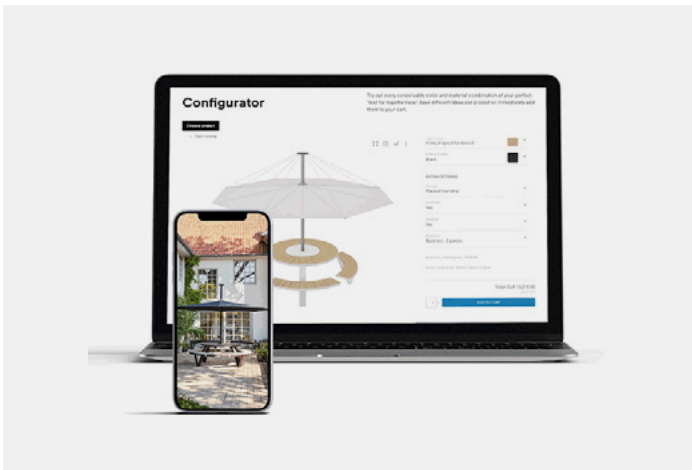

## REFERENCES

We are proud to work with clients around the world across a wide range of sectors. No matter the scope of your project, our collection offers a solution for every space. Just access the references gallery and filter on setting or product type to get inspired. Create mood boards for your projects by saving everything you need from our website.

[www.extremis.com/references](http://www.extremis.com/references)

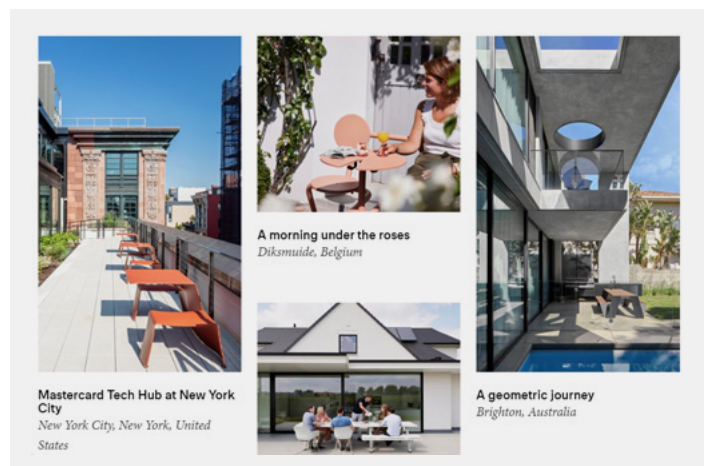

# Wheelchair accessibility



Our innovative tables and picnic benches have been built with wheelchair users in mind. This not only allows the users to gain access to the tables but also contributes to the social aspects of sitting at the same table. Besides facilitating wheelchair access, this furniture is also perfect for pushchairs. They are 'Tools for Togetherness' for everyone and support full inclusivity.

As specifications for wheelchair accessibility vary around the world, please visit our technical sheets to ensure the measurements of each solution meets the specifications of your local requirements.

The following products don't need any product modifications.

## AMAI

Double side access

Tabletop at standard position



Accessible on both sides



Not possible when tabletop is put in the highest position



Accessible on both sides



Not possible on both ends

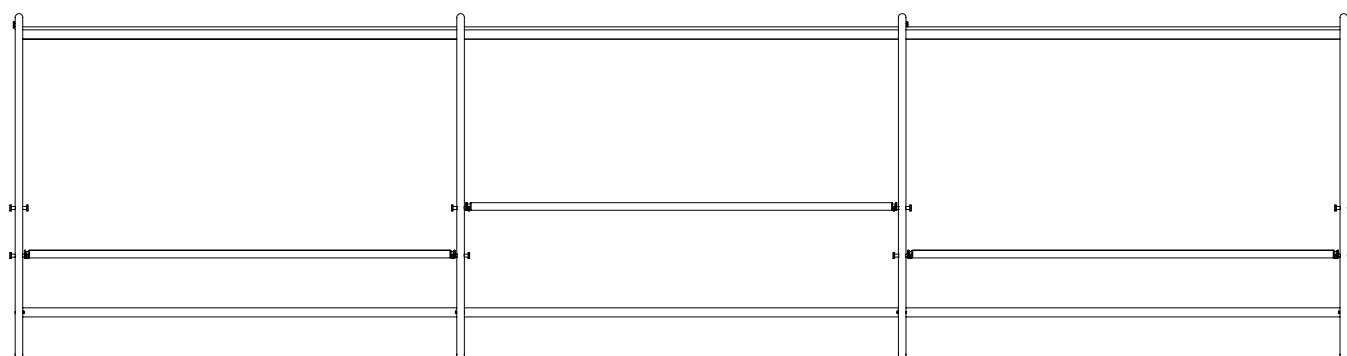

68,5 cm



**HOPPER BENCH**  
Single side access

Only accessible on side with no bench

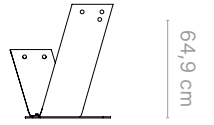

**HOPPER BENCH AA**  
Single side access

Only accessible on side with no bench

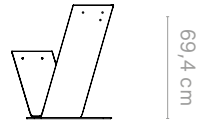

**HOPPER COMBO**  
Single side access

Only accessible on side with no bench

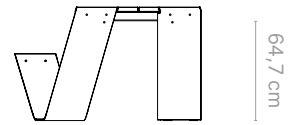

**HOPPER COMBO AA**  
Single side access

Only accessible on side with no bench

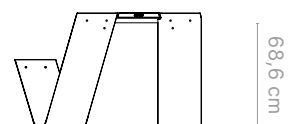

### MARINA COMBO

Double side & Single end access



Accessible on this end



Accessible on sides with no benches



Not possible on this end

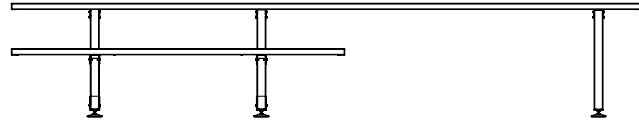

71 cm

### MARINA PICNIC

Double end access

Not possible for the 165 cm version



Accessible on both ends

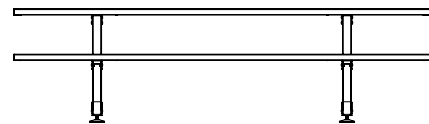

71 cm

### MARINA DOUBLE DESK

Double side access



Not possible on both ends



Accessible on both sides

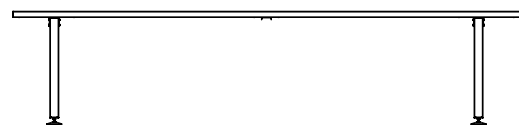

71 cm

### MARINA TABLE

Double side access



Not possible on both ends



Accessible on both sides

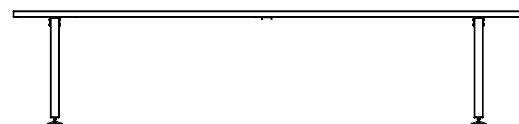

71 cm

**MANILLE**

Double end acces

Accessible  
on both ends

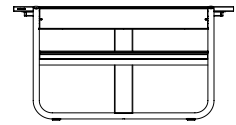

68,2 cm

**PANIGIRI**

Double side & Double end access

Accessible  
on both ends



Accessible on sides  
with no benches

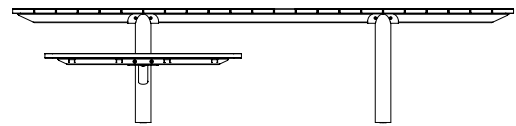

65,2 cm

**PICNIK**

Single end access

Accessible on the open  
side of the tabletop

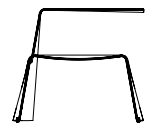

72,1 cm

**GARGANTUA**

Single end access

Two benches at  
tabletop height

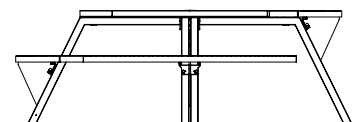

70,8 cm

# Virus wheelchair accessibility

Our furniture is made to last, so picking the right piece is a crucial step in completing your project plans. We strive to make our furniture both accessible and inclusive. So with some minor adaptations we made the Virus picnic tables accessible for those with mobility issues. By removing one of the legs, in the Virus 4 or 5-seater, a wheelchair fits perfectly in the gap.

## VIRUS 4-SEATER WHEELCHAIR

One leg has to be removed  
Only possible when combined with floor fastening

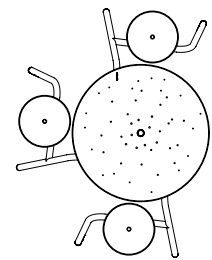

Virus 4-seater  
Standard tabletop  
(incl. floor fastening) **€ 1820**

Virus 4-seater  
Solid tabletop  
(incl. floor fastening) **€ 1800**

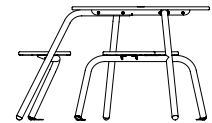

68,9 cm

## VIRUS 5-SEATER WHEELCHAIR

One leg has to be removed

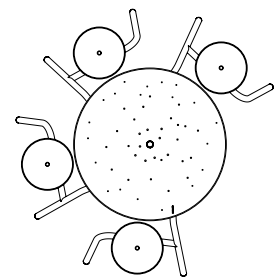

Virus 5-seater  
Standard tabletop **€ 2095**

Virus 5-seater  
Solid tabletop **€ 2070**

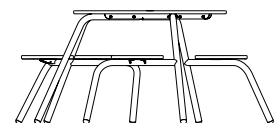

68,9 cm

Virus 5-seater  
Standard tabletop  
(incl. floor fastening) **€ 2215**

Virus 5-seater  
Solid tabletop  
(incl. floor fastening) **€ 2190**

# Hopper picnic wheelchair accessibility

Our baseline 'Tools for Togetherness' implies that we provide high quality products for everybody, even our wheelchair using friends. Proof are the tailor-made versions of our popular Hopper picnic tables. By shortening the benches on one or two sides, wheelchair access is facilitated. Let's bring inclusivity to the table!

The price of the Hopper picnic is subject to size, finish and quantity. Keep in mind that these special Hopper picnic versions are only available in 300 cm and 360 cm.

## HOPPER PICNIC WHEELCHAIR

One bench has been made shorter to gain room for a wheelchair  
A stainless steel connection piece connects the two legs

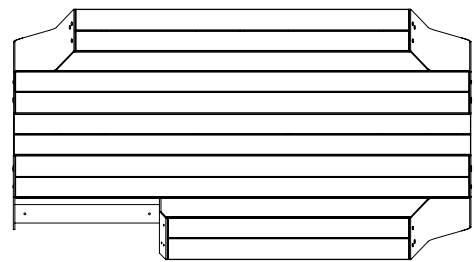
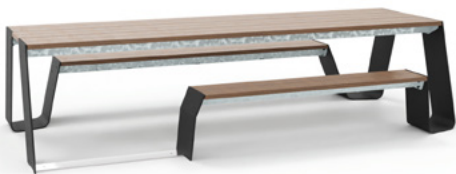

94 cm

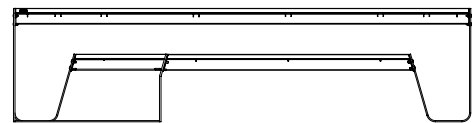

64,7 cm

## HOPPER PICNIC WHEELCHAIR AA

One bench has been made shorter to gain room for a wheelchair  
A stainless steel connection piece connects the two legs

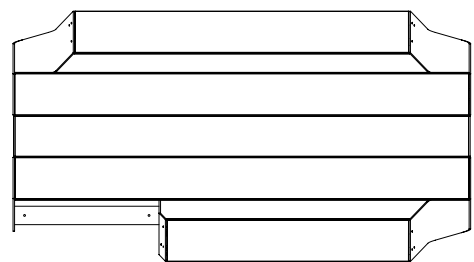
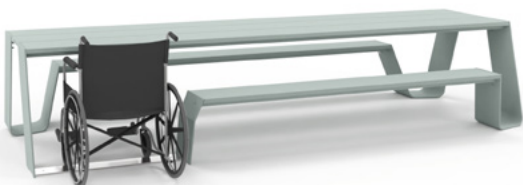
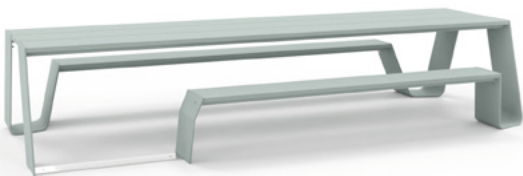

94 cm

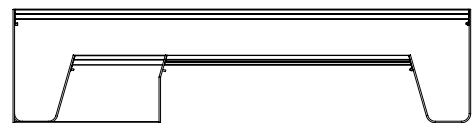

68,6 cm

# Maintenance tools

The extreme quality of the materials used in Extremis products and the way they are designed only serve one good cause: To. Last. Longer. Nothing goes without a little effort however. Maintenance is needed to stand the test of time. So please have a look at our maintenance products and our tips to keep your tool for togetherness in excellent shape.

[www.extremis.com/maintenance](http://www.extremis.com/maintenance)

Order your maintenance tools on our Dealer Portal

[www.extremis.com/portal](http://www.extremis.com/portal)



## WOOD CLEANER - 1L

Wood Cleaner is a cleansing shampoo for wooden furniture. The product removes gray discoloration, green deposits and dirt

OND001



## MULTI CLEANER - 0,5L

Extremis Multi Cleaner is a ready to use cleaner. Its powerful formula removes the most persistent stains

OND004



## WOOD PROTECTOR - 1L

Protect your wood regularly from UV and inclement weather. The Extremis wood protector is a 100% natural product

OND002



## EXTREMIS BRUSH

Use this hand scrubber in combination with Extremis Wood Cleaner and Multi Cleaner to remove persistent dirt

OND006



#### **WOOD CLEANING KIT**

Wood Cleaner – Wood protector 1L – Extremis brush – Tape - Sanding block - Brush

OND057



#### **GENERAL CLEANING KIT**

Multi Cleaner - Sponge - Microfiber cloth - Extremis brush

OND058

# Wood

**Wooden structures in the sea such as pontoons, piers, jetties and so on are living proof of the soundness of wood as a suitable material for the structure and finish of outdoor applications. Almost constantly in contact with salt water and subject to biting winds and high UV densities, the wood may well turn grey, but it lasts for decades, which makes it a superb material.**

Choose wisely

Wood is a living material and in spite of the superior quality provided by the species we use, it constantly has to adapt to extreme changes in temperature and humidity. Due to internal stress resulting from these constant adaptations the wood "warps". This warping can lead to cracking, among other things. Changes in color and structure can also appear. These characteristics are typical of the material and by choosing this material you accept them. When delivered, the wooden parts of our products are untreated. Exposure to sun and rain will gradually change their color to silvery gray, and also roughen the surface. We strongly recommend that you treat your wood regularly with wood oil to protect it from stains and to slow down the roughening process. In some cases, white spots might appear in the wood, especially in Iroko hardwood. These tiny dots are calcium carbonate deposits that become a part of the wood when the tree absorbs water from an alkaline soil. The calcium fragments don't change the quality of the wood, but they are visible to the eye. From a durability standpoint, Extremis will not throw out this quality wood, however, when there are more than ten spots visible per 100 cm<sup>2</sup>, the wood is no longer used in our regular sale, but gets a second life for demonstration and R&D purposes.

## Iroko

Used for Anker - Gargantua - Hopper - Pantagrue - Walrus

Iroko is an African species of tropical hardwood. The high quality allows us to make wide tabletop segments out of one piece of wood. The color and characteristics of the wood are similar to teak. Our suppliers have their own concession and guarantee to deliver only the best quality Iroko hardwood, with a clear paper trail to guarantee sustainable entrepreneurship.

Choose wisely

Like all wood, Iroko will gradually become rough and grayish by exposure to the sun and rain, small cracks and crevices may also appear as part of this process. We strongly advise to yearly treat the furniture with our Wood Protector. The natural oil protects the wood from moisture and spilled liquids, which keeps the wood stable for longer and keeps stains superficial.

## Iroko FSC 100% \*

Used for Gargantua



The FSC®-certified wood originates from sustainably-managed forests and that each step of the wood-chain is checked both on a social, ecological and economical level. These labels are not a guarantee of quality, but a guarantee of environmentally appropriate, socially beneficial and economically viable wood.

Choose wisely

Like all wood, Iroko will gradually become rough and grayish by exposure to the sun and rain, small cracks and crevices may also appear as part of this process. We strongly advise to yearly treat the furniture with our Wood Protector. The natural oil protects the wood from moisture and spilled liquids, which keeps the wood stable for longer and keeps stains superficial.



# Hellwood

Used for Anker

Extremis Hellwood is European Ash wood that has been through purgatory to steel it against all kinds of hellish ordeals. And there are more than enough of them out there: UV rays, rain and acid rain, fluctuating humidity levels, frost, extreme heat and so on. Our preservation gives the fibers greater internal stability and increases their resistance to rotting. In this way, we obtain a type of wood that belongs in Durability Class I, just like the very best tropical wood. An attractive side-effect of the process, of course, is the wood's dark coloring.

# Hellwood 100% PEFC

Used for AMAi - Hopper - Manille - Panigiri - Pantagruel - Walrus



Extremis Hellwood is European Ash wood that has been through purgatory to steel it against all kinds of hellish ordeals. And there are more than enough of them out there: UV rays, rain and acid rain, fluctuating humidity levels, frost, extreme heat and so on. Our preservation gives the fibers greater internal stability and increases their resistance to rotting. In this way, we obtain a type of wood that belongs in Durability Class I, just like the very best tropical wood. An attractive side-effect of the process, of course, is the wood's dark coloring.

Choose wisely

Like all wood, Hellwood will gradually become rough and grayish by exposure to the sun and rain, small cracks and crevices may also appear as part of this process. We strongly advise to yearly treat the furniture with our Wood Protector. The natural oil protects the wood from moisture and spilled liquids, which keeps the wood stable for longer and keeps stains superficial.

Choose wisely

Like all wood, Hellwood will gradually become rough and grayish by exposure to the sun and rain, small cracks and crevices may also appear as part of this process. We strongly advise to yearly treat the furniture with our Wood Protector. The natural oil protects the wood from moisture and spilled liquids, which keeps the wood stable for longer and keeps stains superficial.

\* Pay attention to the FSC®-logo, only the products with this logo are FSC®-certified products.

# Rubberwood

Used for Sticks

---

The wood of the rubber tree (rubberwood) is very valuable: it has a very nice light color, high stability as a result of the low level of shrinkage and it is very easy to process. Perfect for indoors! Rubberwood is very popular for making stairs and furniture... or basically anything made of wood. Choose the natural version, or the dark washed version using oil. At Extremis we first use the latex from the rubberwood tree to make the rubber Sticks bases and once the trees are too old to tap latex, instead of chopping and burning the wood, we use the wood to make the rubberwood Sticks bases.

Choose wisely

---

As rubberwood is only used inside, it needs no maintenance. The dark washed version has a dark gray look with the wood grain still visible. This is far from a black base.

# Oak

Used for Tiki

---

Oak wood is a type of hardwood commonly used for furniture making, flooring, barrel making or timber frame buildings. It is mainly appreciated for its robustness and durability. Many also appreciate its prominent grain and light attractive color. Oak is a popular choice for interiors, as it brings a warm, natural feeling to any room.

Choose wisely

---

As most woods, oak wood should be oiled frequently if you want to maintain its look longer. However, since it's a natural material that is easy to repair and refinish and since it is used inside, its maintenance will be lighter than for outdoor use.

# Bamboo

Used for Bistrot

---

Our durable bamboo components are made from solid Bamboo strips originating from China. Thanks to a unique engineering process of compression under high temperature and pressure, an exceptional hardness and durability is achieved. Our suppliers only uses certified environment friendly ingredients for this specific technique. Made with high attention to detail and precision, providing us with a high quality and sustainable product.

Choose wisely

---

Each Bamboo service has been treated with a wood oil to protect it from stains and internal changing climate conditions. The Bamboo wood is easy to clean with water and mild household soap. Don't use aggressive cleaning products or sand the surface.

# Aluminium

---

**Aluminium is one of the most common substances on earth. It is a metal offering an exceptional combination of properties. It is light and 100% recyclable. The alloys we use contain maximum 30% virgin material.**

## Fine structured powder coating

---

Used for AMAi - Bistrot - Hopper - Kosmos - Picnik - Sensu - Sol+Luna

Powder coating is a technique of applying dry paint to a part. The powdered paint is electrostatically charged and sprayed onto the object. The object is then placed in an oven and the powder particles melt and coalesce to form a continuous film. The fine textured powder-coating has a high scratch resistance, perfect for intensive use.

Choose wisely

---

Choose white powder coating, only if you are willing to clean the surface regularly. There is nothing uglier than a dirty piece of design furniture, right?

## Anodized

---

Used for Sol+Luna shade

Anodizing is a process which increases the thickness of the natural oxide layer on the surface of the aluminium. This layer protects the aluminium from corrosion. We have chosen not to give the aluminium any further treatment, as this would not lengthen its lifespan and would also be very bad for the environment.

Choose wisely

---

Easy to clean with lukewarm water and a mild detergent.

# Steel

---

**Steel is an alloy of iron and other elements, primarily carbon, that is widely used in construction and other applications because of its high tensile strength. Steel's base metal is iron, the element that rusts when in direct contact with oxygen. There are three ways to cope with this property: block direct contact with the air (e.g. by galvanizing), replace a certain amount of iron with carbon (e.g. stainless steel), or use rust as a finish (e.g. weathering steel).**

Choose wisely

---

Steel may rust sooner or later, so try to keep surfaces clean and dry, and in any case do not leave metal objects outside on top of any other steel surface. A chemical reaction occurs that will affect the other surface. As soon as rust has been noticed, act immediately and accordingly, as rust accelerates rusting.

# Galvanized

Used for Acacia - AMAi - Anker - Captain's Chair - Gargantua - Hopper - Inumbrina - Kosmos - Manille - Panigiri - Pantagruel - Senu - Walrus

---

Galvanization is the most durable method for protecting metal from rusting. The metal is immersed in a zinc bath which results in a protective layer. If the layer gets damaged, the metal underneath will start rusting. However any damage can be touched up with zinc paint available from any DIY store. Galvanized steel has a very long life span and is perfectly recyclable if necessary.

Choose wisely

---

We call it the George Clooney of coating techniques: its looks improve better with age... Our tools with galvanized surfaces are masters of camouflaging dirt, thanks to the materials rough texture. At first, galvanized pieces look very shiny, but they will gradually turn matt under the influence of sun and rain. Rain may also cause dark stains underneath the connection zones.

# Fine structured powder coating

Used for AMAi - Anker - Bistrou - Captain's Chair - Marina - Pantagruel - Tiki - Virus

---

Powder coating is a technique of applying dry paint to a part. The powdered paint is electrostatically charged and sprayed onto the object. The object is then placed in an oven and the powder particles melt and coalesce to form a continuous film.

Choose wisely

---

Choose white powder coating, only when you are willing to clean the surface regularly. There is nothing uglier than a dirty piece of design furniture, right? Our glossy powder-coating is very maintenance-friendly, however.

# Stainless 316

Used for AMAi shade - Gargantua - Hopper shade - Inumbra - Kosmos shade - Manille shade

---

The highest stainless steel quality available is type AISI 316. Aggressive environmental conditions caused by chlorides, acid rain, salt and other rusty materials will require periodic maintenance.

Choose wisely

---

We advise a regular treatment with stainless steel cleaner or protector, especially in aggressive environments. Products to clean and protect are widely available.

# Stainless 304

Used for Inumbra - Inumbrina - Kosmos shade

---

For some products we combine different high quality types of stainless steel. Aggressive environmental conditions caused by chlorides, acid rain, salt and other rusty materials will require periodic maintenance.

Choose wisely

---

We advise regular treatment with stainless steel cleaner or protector, especially in aggressive environments. Products to clean and protect are widely available.

# Fine structured powder coated ZnAlMg

Used for AMAi - Anker - Tiki table - Virus

---

ZnAlMg-dipping is an alternative to hot dip galvanization and is the best choice for more detailed products that need to be coated afterwards. Thanks to its unique composition, ZnAlMg provides high level of surface and cut-edge protection, even in the most hostile environments. It is produced on a classic hot dip galvanising line which molten bath has a unique chemical composition including zinc, aluminium, and magnesium, the perfect base layer for powder coatings.

Choose wisely

---

Choose white powder coating, only if you are willing to clean the surface regularly. There is nothing uglier than a dirty piece of design furniture, right?

# Fine structured powder coated stainless steel

Used for Acacia - Bistrot - Captain's Chair - Inumbra - Manille - Panigiri

---

Powder coating is a technique of applying dry paint to a part. The powdered paint is electrostatically charged and sprayed onto the object. The object is then placed in an oven and the powder particles melt and coalesce to form a continuous film.

Choose wisely

---

Choose white powder coating, only if you are willing to clean the surface regularly. There is nothing uglier than a dirty piece of design furniture, right?

# Composites & plastics

---

**A composite is made of at least two constituent materials with different material properties, resulting in a new material with better characteristics. We add plastics to this category, as no plastic is ever applied without adding fibres or fillers.**

## Fiberglass

Used for Sticks

---

Fiberglass reinforced polyester resin material is made with what is called the pull-trusion technique. Pull-trusion is a non-stop process of fiberglass wires pulled through a bath of polyester resin that harden in a matrix afterwards to get their final shape. The main advantages of this material are its strength, corrosion-durability and light weight.

Choose wisely

---

Choose white fiberglass tabletops and benches only if you are willing to clean the surface regularly. Don't use aggressive detergents or abrasives as you will scratch the invisible UV layer. Fiberglass sawdust may stick to the surface use gloves for installation, or clean beforehand. Tree leaves, dust, CO2 emissions etc. may leave marks on a spotless white surface, so keep this in mind when choosing the perfect location for your product.

## Coated fiberglass

Used for Marina

---

Coated fiberglass is a technique of applying wet paint to a fiberglass profiles. The paint is sprayed onto the profiles. The object is then placed in an oven to form a continuous film.

Choose wisely

---

Choose light colors, only if you are willing to clean the surface regularly. There is nothing uglier than a dirty piece of design furniture, right?

## HPL

Used for Kosmos - Pantagruel - Sol+Luna

---

High pressure laminate (HPL) is a flat panel based on thermosetting resins, homogeneously reinforced with wood fibres and manufactured under high pressure and at high temperatures. Its integrated surface is based on pigmented resins cured by electron beams. The modulus of elasticity and high tensile and flexural strength guarantee HPL's high impact resistance. The closed surface makes it easy to clean.

Choose wisely

---

Choose a white HPL tabletop only if you are willing to clean the surface regularly.

# Polypropylene

Used for Captain's Chair

---

Polypropylene is resistant to stress corrosion. It may sound crazy that corrosion can also occur in plastics but it is true. This results in cracking, especially in areas where mechanical stress occurs in combination with a chemical attack. PP is a plastic that has very low susceptibility to this.

Choose wisely

---

A white polypropylene surface may be more sensitive to stains than a black one. Polypropylene is quite a soft material and thus sensitive to scratches.

# Rubber

Used for Sticks

---

The rubber tree gave us wood, but before that, it gave us rubber of course! Sourced and locally manufactured in Sri Lanka, these rubber bases are the only products in our range that don't carry the 'Made in Belgium'-label, as we don't grow rubber trees in Belgium.

Choose wisely

---

Natural rubber has the color of pale skin. The black color is obtained by adding carbon, silica or carbon chalk before vulcanization. The carbon chalk can cause black stripes on the floor, but they can easily be removed.

# Concrete

Used for Inumbra - Inumbrina - Hopper shade - Kosmos shade

---

Concrete is a composite material composed of sand bonded with a fluid cement that hardens over time. Our concrete blocks are high-pressure moulded to make them stronger.

Choose wisely

---

Use concrete blocks, only if floor fastening is not possible.

# Fabrics & leathers

---

**Yarn is produced by spinning raw fibers to produce long strands. Our textiles are formed by weaving or felting, sometimes coated with acryl, pvc or polyester in order to repel water and dirt. All fabrics are carefully considered and selected for their purpose in an outdoor environment.**

## Sunbrella®

Used for AMAi - Bistrot - Captain's Chair - Gargantua - Hopper - Kosmos - Marina - Panigiri - Pantagruel - Sol+Luna - Tiki - Virus - Walrus

Sunbrella® is an acrylic fabric that is still known as the best outdoor fabric available for making cushions. The raw material is Sunbrella® solution-dyed acrylic fibre. The color pigments are locked right into the very heart of the fibres during the initial stage of the manufacturing process, before the yarn is even made Sunbrella® colors stand up to tough weather conditions and years of sun exposure.

Choose wisely

Our Sunbrella cushions and blankets are machine washable at low temperatures. A white and a colored cushion can both get dirty, but the white one will look dirtier sooner. Do not tumble dry.

## High-tech polyester

Used for AMAi - Inumbra - Inumbrina - Hopper shade - Kosmos shade - Manille shade - Sol+Luna shade

Polyester is the most popular synthetic fibre in the world. The use of special finishing methods makes the fabrics weatherproof, water repellent, dirt repellent, lightfast, etc. High-tech polyester is used for a variety of "sun protection" purposes - from seat cushions to patio furniture through to awning fabrics. High water and UV resistance guarantees an excellent long-term appearance.

Choose wisely

Tree leaves, dust, CO2 emissions, pollution, bird droppings etc may leave marks on a spotless white fabric, so keep this in mind when choosing the perfect location for your shade.

## PU-coated polyester

Used for Acacia

Our PU-coated polyester fabric is a stretchable fabric that is suitable for outdoor use. The fabric water repellent, light weight and flexible. It's mainly used for camping tents, light duty covers, clothing and bags. The stretch quality of the fabric ensures that it never wrinkles.

Choose wisely

Tree leaves, dust, CO2 emissions, pollution, bird droppings etc may leave marks on a spotless white fabric, so keep this in mind when choosing the perfect location for your shade.

## Acrylic

Used for Sensu

This solution-died acrylic fabric is an extensively researched fabric that has been tested and proven to be very hard-wearing. A water-resistant coating prevents water from penetrating the fabric making it an all-weatherproof and long-lasting material.

Choose wisely

Our solution-died acrylic fabric is machine washable at low temperatures. The white and a colored fabric can both get dirty, but the white one will look dirtier sooner. Do not tumble dry.



# Sundance

Used for Walrus

---

Sundance upholstery is an extremely durable PVC material that does not absorb any water or dirt. This smooth, cleanable material keeps care and maintenance to a minimum.

Choose wisely

---

Tree leaves, dust, CO2 emissions, pollution, bird droppings etc. may leave marks on a spotless white fabric, so keep this in mind when choosing the perfect location for your sofa.

# Batyline

Used for Sol+Luna

---

The Batyline range represents the reference openwork material, which is selected by leading brands in office, hotel, restaurant, spa, yacht and cruise ship markets.

Choose wisely

---

Resistant, durable and aesthetic, Batyline is also a material that is extremely simple and easy to clean by simply washing with water or Extremis Multi Cleaner to restore the fabric's original appearance. Of course, a white fabric will be more delicate than most other colors, e.g. with sun cream.

## Be the first to know

---

Facebook: [facebook.com/extremis.be](https://facebook.com/extremis.be)

LinkedIn: [linkedin.com/company/extremis](https://linkedin.com/company/extremis)

Pinterest: [pinterest.com/extremis](https://pinterest.com/extremis)

Instagram: [instagram.com/extremis](https://instagram.com/extremis)

Vimeo: [vimeo.com/extremis](https://vimeo.com/extremis)

Youtube: [youtube.com/user/EXTREMISdesign](https://youtube.com/user/EXTREMISdesign)

## Get in touch

---

### **Extremis HQ - Belgium**

Couthoflaan 20b  
8972 - Poperinge  
BELGIUM  
Tel. +32 57 34 60 20  
[info@extremis.com](mailto:info@extremis.com)  
[www.extremis.com](https://www.extremis.com)

Open from Monday to Friday  
8:30 till 12:30 and 13:00 till 17:00

### **Extremis Inc - North America**

Northland Drive NE 239  
MI 49341 Rockford  
UNITED STATES  
Tel. +1 415 7455768  
[na@extremis.com](mailto:na@extremis.com)

Available from Monday to Friday  
8:00 AM till 12:30 and 1:00 till 5:30 PM







