

Pantagruel tables

© design by Dirk Wynants

extremis®



Dimensions

The Pantagruel table is available in two heights

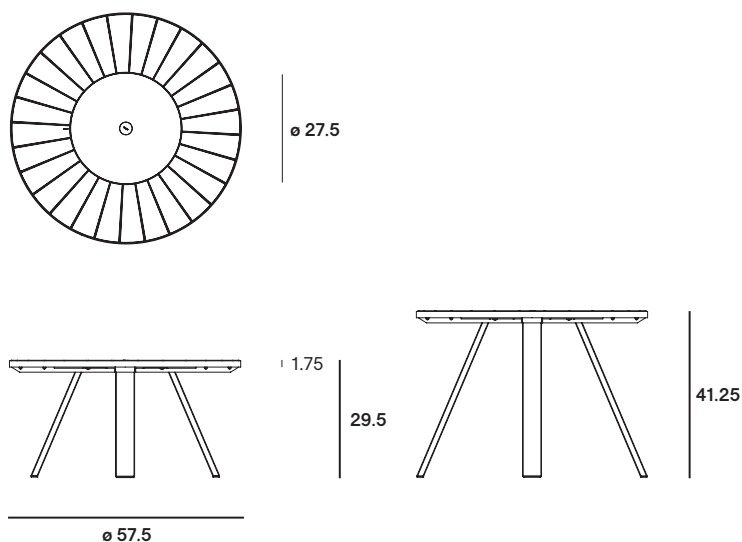

Box dimensions

The Pantagruel tables come in 2 boxes

Box 1: Tabletop

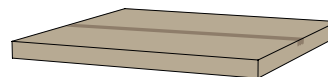

Box 2: Table eggs + mounting kit



Box 3: High table legs + mounting kit



Box dimensions (inch)		L	W	H	Qty	Volume (ft ³)	Gross weight (lb)	Net weight (lb)	Packaging weight (lb)
Pantagruel table	Box 1	60.25	59.0	4.0	1	8.12	152.12	139.33	12.79
Galvanized version	Box 2	39.5	13.5	11.5	1	3.53	55.34	49.38	5.95
Total:						11.65	207.46	188.71	18.74
Pantagruel table	Box 1	60.25	59.0	4.0	1	8.12	152.12	139.33	12.79
Powder coated version	Box 2	39.5	13.5	11.5	1	3.53	55.34	49.38	5.95
Total:						11.65	207.46	188.71	18.74
Pantagruel high table	Box 1	60.25	59.0	4.0	1	8.12	152.12	139.33	12.79
Galvanized version	Box 3	59.5	13.0	10.5	1	4.59	67.02	59.08	7.94
Total:						12.71	219.14	198.41	20.73
Pantagruel high table	Box 1	60.25	59.0	4.0	1	8.12	152.12	139.33	12.79
Powder coated version	Box 3	59.5	13.0	10.5	1	4.59	67.02	59.08	7.94
Total:						12.71	219.14	198.41	20.73

Floor fastening

The floor fastening is available in one dimension

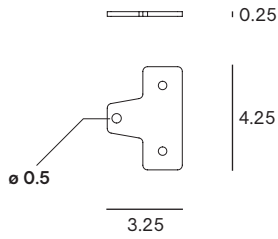

Box dimensions

The floor fastening comes in 1 box

[Box 7: floor fastening set](#)



Box dimensions (inch)		L	W	H	Qty	Volume (ft ³)	Gross weight (lb)	Net weight (lb)	Packaging weight (lb)
Floor fastening	Box 7	8.0	5.75	6.0	1	0.35	2.27	2.12	0.15

Protection felt

The protection felt is available in one dimension

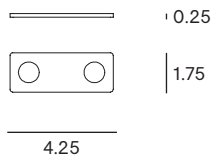

Box dimensions

The protection felt comes in 1 box

[Box 8: protection felt set](#)



Box dimensions (inch)		L	W	H	Qty	Volume (ft ³)	Gross weight (lb)	Net weight (lb)	Packaging weight (lb)
Protection felt	Box 8	8.0	5.75	6.0	1	0.35	0.18	0.03	0.15

Materials & colors

Check price list or www.extremis.com for current materials & colors

Tabletop

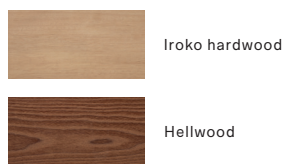

Frame & legs

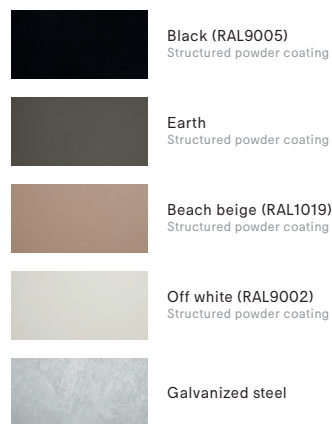

HPL Lazy Susan

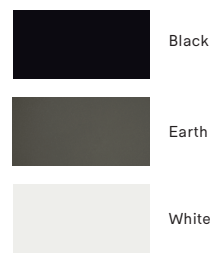

Materials	Key facts	Thickness inch	Layer thickness micron	Density	In/outdoor	Water	UV color fastness	Flame retarding
Iroko tabletop	<ul style="list-style-type: none"> Durability CLASS 1 Feels comfortable in all weather conditions Advisable to oil the wood 	0.79	n.a.	37 à 43 lb/ft ³	Outdoor & indoor	n.a.	Untreated wood turns grey after a while	/
Hellwood tabletop	 <ul style="list-style-type: none"> Durability CLASS 1 Carries the PEFC™ label for durable forestry Feels comfortable in all weather conditions Advisable to oil the wood 	0.79	n.a.	37 lb/ft ³	Outdoor & indoor	n.a.	Untreated wood turns grey after a while	/
Hot dip galvanized steel frame & legs	<ul style="list-style-type: none"> Most durable method for protecting metal from rusting Protective layer Very long life span 100% recyclable Cradle to Cradle Certified™ 	0.07 - 0.23	50 - 100	0.47 10 ³ lb/ft ³	Outdoor & indoor	n.a.	Very good, galvanisation will however become less shiny when used outdoors	NEN-EN13501-1 A1 *
Structured powder coated zinc steel frame	<ul style="list-style-type: none"> Easy to clean Electro galvanized (for protection against rust), then powder coated More scratch-resistant than non structured powder coating 	0.15 - 0.23	+/- 100	0.47 10 ³ lb/ft ³	Outdoor & indoor	n.a.	Very good: color can fade to some extent when exposed to UV	NEN-EN13501-1 A1 *
Structured powder coated stainless steel legs	<ul style="list-style-type: none"> Easy to clean Stainless steel (for protection against rust), then powder coated More scratch-resistant than non structured powder coating 	0.07	50 - 100	0.50 10 ³ lb/ft ³	Outdoor & indoor	n.a.	Very good: color can fade to some extent when exposed to UV	NEN-EN13501-1 A1 *
High pressure laminate Lazy Susan	<ul style="list-style-type: none"> Manufactured under high pressure Reinforced with wood fibres Flat panel High impact resistance Easy to clean 	0.51	n.a.	0.08 10 ³ lb/ft ³	Outdoor & indoor	n.a.	>6 (EN438-2:27) en (ASTM G53-91)	/

NEN-EN13501-1 A1 Class A1 products will not contribute to fire in any stage, including fully developed fire. For this reason, they are assumed to be capable of satisfying all requirements of all lower classes as well.

Good to know

- PEFC™ certified wood (Hellwood) originates from sustainably managed forests.
- The hole in the tabletop to place a shade in is ø2.5 inch.
- The Pantagruel tables are fitted with a Lazy Susan, a central rotating tray, to easily pass things through.



F.A.Q.

Q: Do you need to oil the wood?

A: Just like other types of wood, wood will gradually become rougher and start to turn grey as a consequence of exposure to the sun and rain. Small cracks and crevices can also appear as part of this process. We strongly advise everyone to treat the furniture with our Wood Protector. This 100% natural oil controls the moisture level within the wood, which makes the planks stay stable for longer, and the layer of oil also helps to prevent spilled liquids from being absorbed, so that stains tend to stay superficial. It is best to repeat this treatment at regular intervals.

Maintenance

Find maintenance instructions at the [product care](#) section of [extremis.com](#) for

POWDER COATED PARTS

- White powder coating obviously requires more maintenance.

GALVANIZED PARTS

- How to repair a damaged zinc layer.

WOOD

- Clean regularly with mild detergent.
- Thorough cleaning with Extremis Wood Cleaner.
- Oil the wood with Extremis Wood Protector. We recommend oiling the wood at regular intervals depending from location and general weather conditions.
- In order to smoothen the surface again after a thorough cleaning, lightly sand your wood with 120 grit sanding paper or a sanding pad.

RECOMMENDED USE

- For Extremis Wood protector:

 1L	 0.5L	
7 to 10 wood care treatments	3 to 5 wood care treatments	100 - 150 ml for one Pantagruel table

Floor fastening

Pantagruel comes with an optional floor anchoring set: four steel plates to be fixed with bolts.

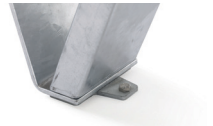

Warnings

General

- Do not use any sharp tools to open the packaging.
- We strongly advise against using power tools.
- Tripping hazard, mind your step.
- Do not put out cigarettes on the table.
- Not graffiti proof.
- Do not leave children unattended whilst playing on the table.
- To avoid danger of suffocation, keep plastic bags away from babies and children.
- Colors can differ over years and from batch to batch.

Product

- Do not stand or jump on the table.
- Do not drag the table, but carry it with minimum 2 people.
- Anchoring the product has to be done by qualified people.
- For anchoring: use suitable bolts or screws from a specialized store depending on the material your terrace is made of.
- There is protection felt for delicate floors or indoor use.
- Do not stand on the Lazy Susan.
- The white Lazy Susan reflects in the sunlight.
- Mind your fingers whilst assembling the Lazy Susan.

Wood

- When delivered, the wood is untreated.
- Wood is a natural material and its look is different for every slat, plank and tree.
- Wood will gradually become rougher and start to turn grey as a consequence of exposure to the sun and rain. We recommend oiling the wood at regular intervals depending from location and general weather conditions.
- Clean regularly with mild detergent. Never use a high pressure cleaner as this will roughen the wood's smooth surface and irreparably damage the wood's fiber.
- Thorough cleaning with Extremis Wood Cleaner.
- We strongly recommend that you treat your wood with wood protector to protect it from stains - small cracks and crevices can also appear as part of this process. We strongly advise everyone to treat the furniture with our Wood Protector.

Galvanized steel

- Galvanization will become less shiny when used outdoors.
- Flame retarding - NEN-EN13501-1 A1 - Class A1 products will not contribute to fire in any stage, including fully developed fire. For this reason, they are assumed to be capable of satisfying all requirements of all lower classes as well.
- Possible impurities in the immersion tank can

cause black marks during galvanization, which are intrinsic to this industrial finishing technique.

- White marks on this zinc layer are also intrinsic to this procedure and will disappear when the furniture is put outdoors.
- This industrial finishing technique may result in a rougher surface. This is intrinsic to the process.

Powder coating

- White powder coating requires more maintenance.
- Do not use abrasive scouring powders or scourers as they will scratch the surface.
- Color can fade to some extent when exposed to UV.
- Flame retarding - NEN-EN13501-1 A2-sl - Satisfying the same criteria as Class B for the SBI-test according to EN13823. In addition, under conditions of a fully developed fire these products will not significantly contribute to the fire load and fire growth.
- Dark colors can get very hot in sunny weather.

HPL

- UV color fastness: >6 (EN438-2:27) en (ASTM G53-91)