

# Sol+Luna

© Design by Dirk Wynants for Extremis, 2016

extremis®



## Dimensions

The Sol+Luna is available in one dimension

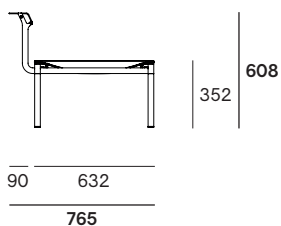
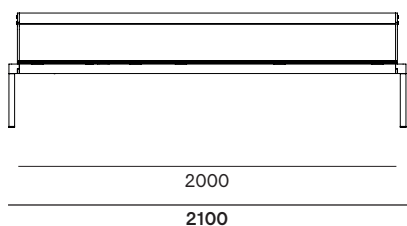
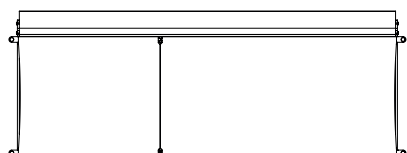

## Box dimensions

The Sol+Luna comes in 3 boxes

Box 1: Frame



Box 2: Legs, backrest supports & mounting kit



Box 3: Backrest



Box dimensions (mm)		L	W	H	Qty	Volume (m <sup>3</sup> )	Gross weight (kg)	Net weight (kg)	Packaging weight (kg)
Sol+Luna Australis	Box 1	2060	710	105	1	0,15	22,16	19,26	2,90
	Box 2	735	660	105	1	0,05	17,40	16,90	0,50
	Box 3	2015	150	60	1	0,02	7,70	6,60	1,00
Total						<b>0,22</b>	<b>47,26</b>	<b>42,86</b>	<b>4,40</b>

# Flat shade

The flat shade is available in one dimension

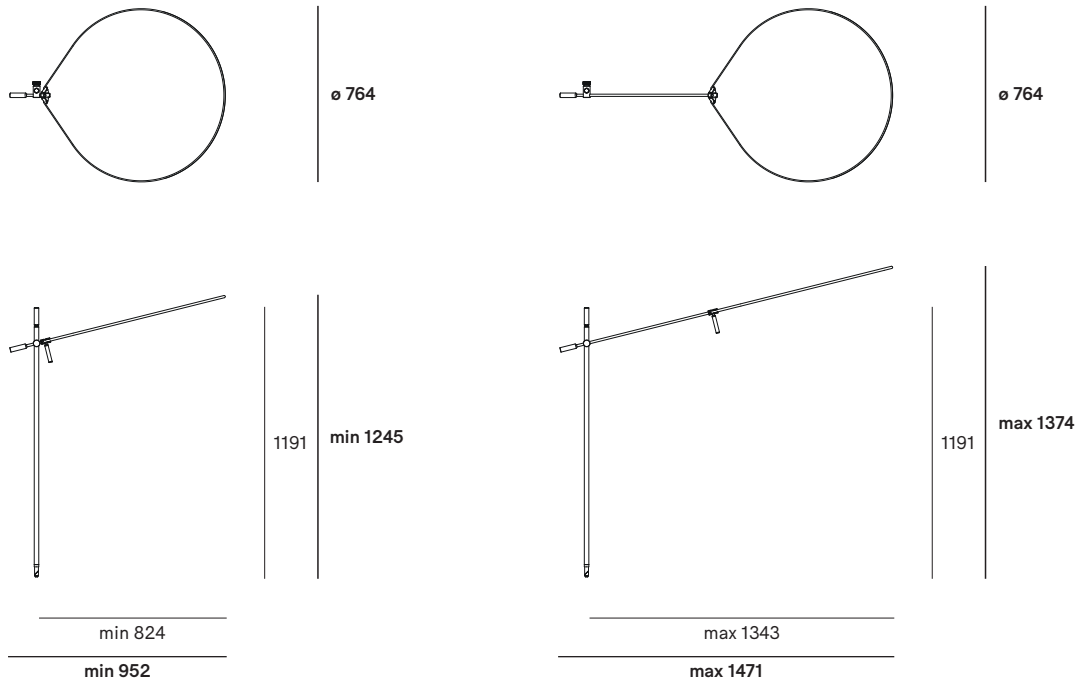

The flat shade in combination with Sol+Luna sofa sunbed

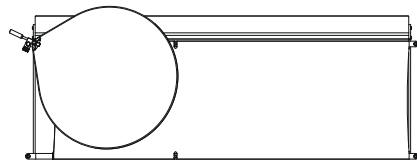

Choose one of the four plug-in holes

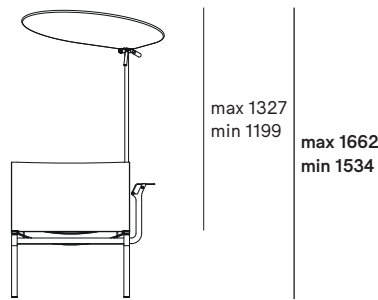
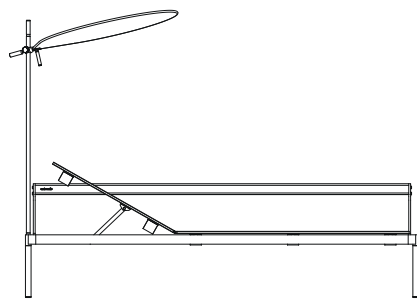
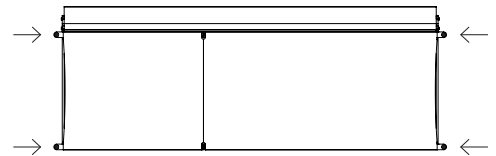

## Box dimensions

The flat shade come in 1 box and 1 bag

Box 4: Fabric with sliding system + cover



Plastic bag 1: Tube



Box dimensions (mm)		L	W	H	Qty	Volume (m <sup>3</sup> )	Gross weight (kg)	Net weight (kg)	Packaging weight (kg)
Flat shade	Box 5	790	790	52	1	0,03	2,87	1,29	1,58
	Bag 1	1250	20	20	1	0,01	1,16	1,06	0,10
Total						<b>0,04</b>	<b>4,03</b>	<b>2,35</b>	<b>1,58</b>

# Shade with LED

The shade with LED is available in one dimension

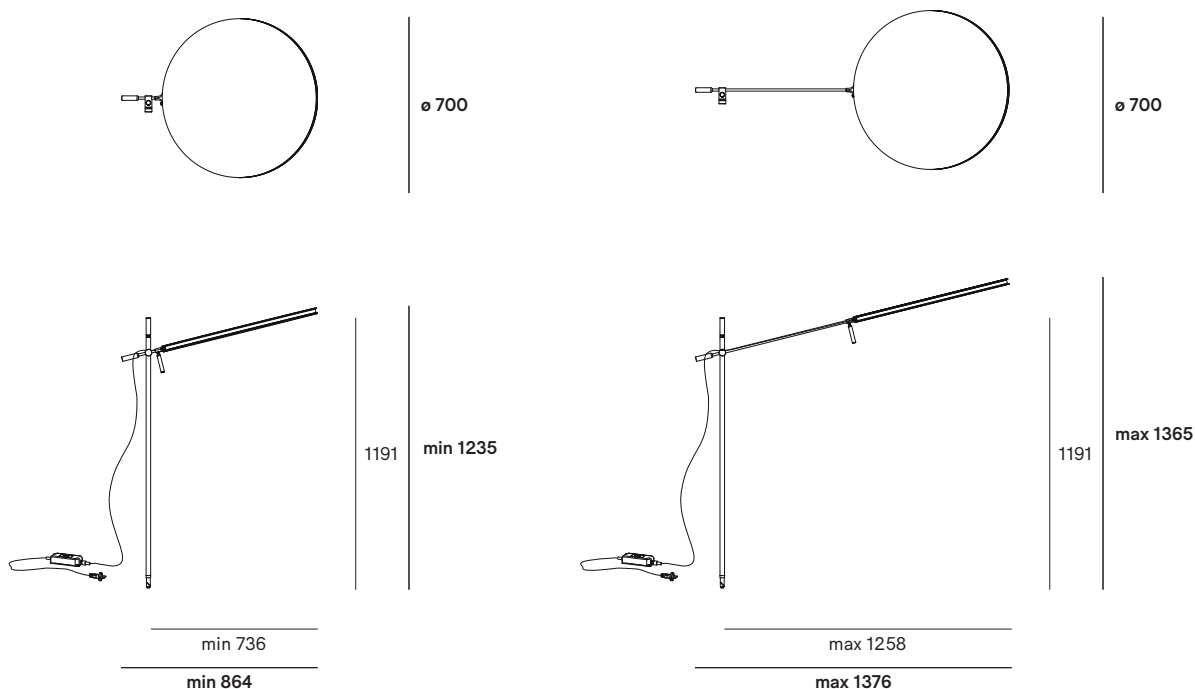

The shade with LED in combination with Sol+Luna sofa sunbed

Choose one of the four plug-in holes

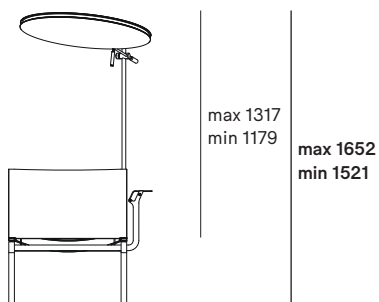
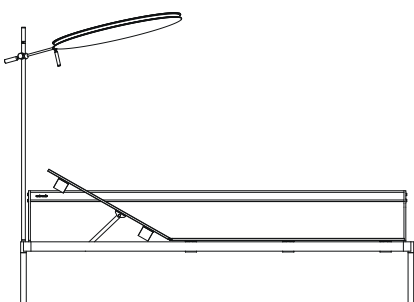
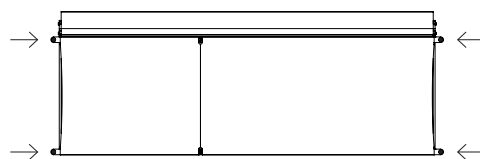
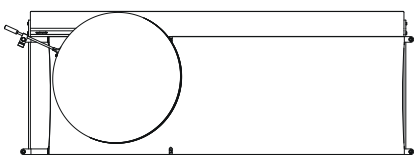

## Box dimensions

The shade with LED come in 1 box and 1 bag

Box 5: Fabric with sliding system & power supply + cover

Plastic bag 1: Tube



Box dimensions (mm)		L	W	H	Qty	Volume (m <sup>3</sup> )	Gross weight (kg)	Net weight (kg)	Packaging weight (kg)
Shade with LED	Box 6	790	790	52	1	0,03	4,55	2,97	1,58
	Bag 1	1250	20	20	1	0,01	1,16	1,06	0,10
Total						<b>0,04</b>	<b>5,71</b>	<b>4,03</b>	<b>1,58</b>

## Recliner dimensions

The backrest is available in one dimension

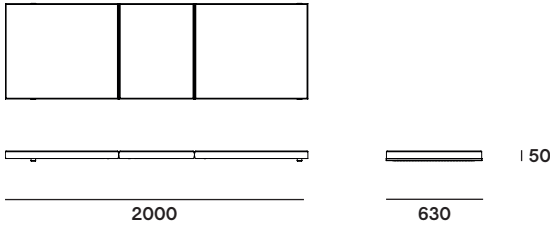

## Bag dimensions

The backrest comes in one bag

Plastic bag 2: recliner cushions



## Seperate comfort cushions dimensions

The set of 3 seperate comfort cushions is available in one dimension

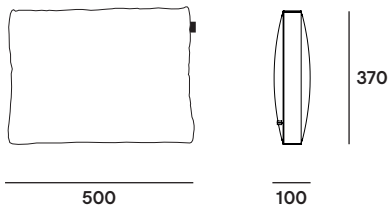

## Bag dimensions

The set of 3 seperate comfort cushions comes in one bag

Plastic bag 3: set of 3 seperate comfort cushions

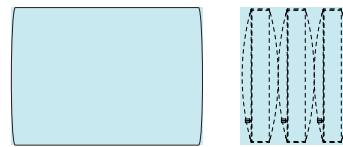

## Connect comfort cushions dimensions

The connected comfort cushions is available in one dimension

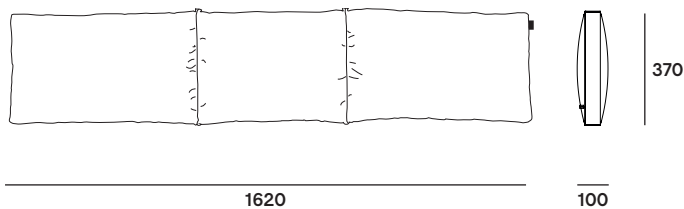

## Bag dimensions

The connected comfort cushions comes in one bag

Plastic bag 4: connected comfort cushions

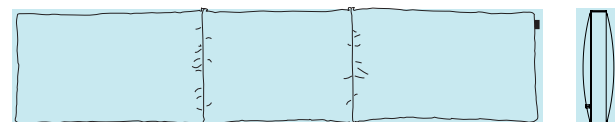

Box dimensions (mm)		L	W	H	Qty	Volume (m <sup>3</sup> )	Gross weight (kg)	Net weight (kg)	Packaging weight (kg)
Connected comfort cushions	Bag 4	1620	100	370	1	0,06	3,30	3,20	0,10

## Bolster pillow set dimensions

The bolster pillow set is available in one dimension

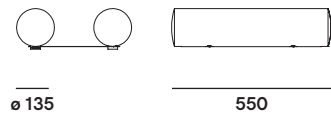

## Bag dimensions

The bolster pillow set comes in one bag

[Plastic bag 5: bolster pillow set](#)



Box dimensions (mm)		L	W	H	Qty	Volume (m <sup>3</sup> )	Gross weight (kg)	Net weight (kg)	Packaging weight (kg)
Bolster pillow set	Bag 5	550	270	135	1	0,02	2,00	1,90	0,10

## Wheels dimensions

The wheels are available in one dimension

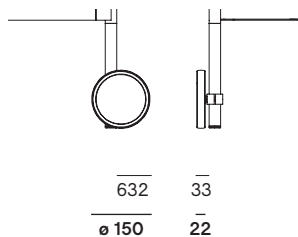

## Box dimensions

The wheels come in one box

[Box 5: set of 3 separate comfort cushions](#)



## Tapa table dimensions

The tapa table is available in one dimension

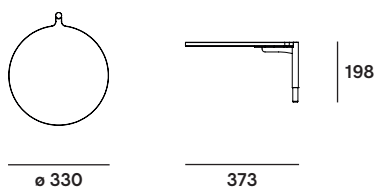

## Bag dimensions

The tapa table comes in two boxes

[Box 6: Tabletop](#)

[Box 7: Table support + mounting kit](#)



Box dimensions (mm)		L	W	H	Qty	Volume (m <sup>3</sup> )	Gross weight (kg)	Net weight (kg)	Packaging weight (kg)
Tapa table	Box 6	340	340	25	1	0,01	1,37	1,12	0,25
	Box 7	210	160	100	1	0,01	0,80	0,65	0,15
					Total	<b>0,02</b>	<b>2,17</b>	<b>1,77</b>	<b>0,40</b>

## Locker dimensions

The locker set is available in one dimension

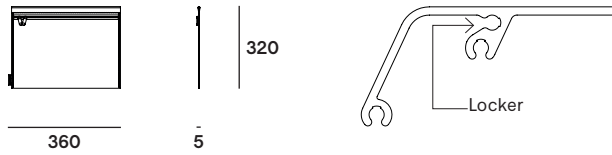

## Bag dimensions

The locker pillow set comes in one bag

Plastic bag 6: locker

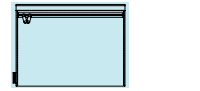

## Storage net dimensions

The storage net is available in one dimension

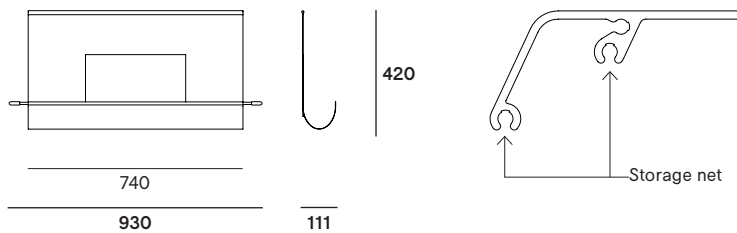

## Bag dimensions

The storage net comes in one bag

Plastic bag 7: storage net

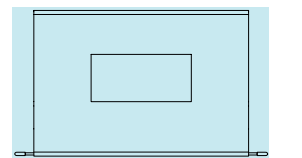

Box dimensions (mm)		L	W	H	Qty	Volume (m3)	Gross weight (kg)	Net weight (kg)	Packaging weight (kg)
Storage net	Bag 7	930	5	600	1	0,02	0,42	0,32	0,10

## Pool towel dimensions

The pool towel is available in one dimension



## Bag dimensions

The pool towel comes in one bag

Plastic bag 8 Pool towel



Box dimensions (mm)		L	W	H	Qty	Volume (m3)	Gross weight (kg)	Net weight (kg)	Packaging weight (kg)
Pool towel	Bag 8	350	310	75	1	0,01	0,96	0,95	0,01

# Materials & colors

Check price list or [www.extremis.com](http://www.extremis.com) for current materials & colors

## Batylite fabric

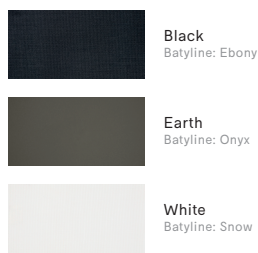

## Frame, legs & backrest

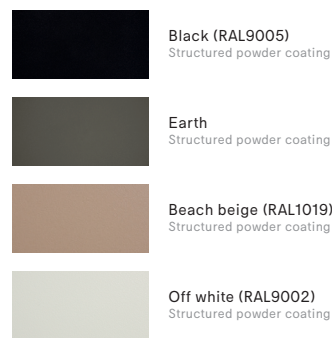

## Sunbrella® cushions

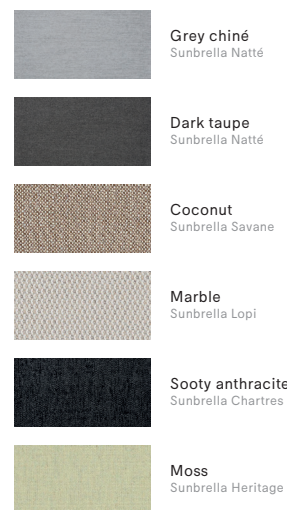

## Pool towel



## HPL tabletop

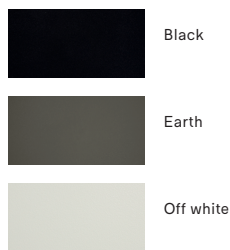

## Wheels

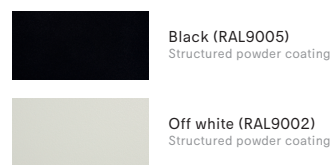

Materials	Key facts	Thickness mm	Layer thickness micron	Density	In/outdoor	Water	UV color fastness	Flame retarding
Batylite	<ul style="list-style-type: none"> <li>Tear resistant extremely strong</li> <li>Exceptional resistance to outdoor conditions</li> <li>Easy upkeep with soapy water or Cleaner 500</li> <li>Tension uniformly conserved: no bagging phenomenon</li> </ul>	0,8	n.a.	560 g/m <sup>2</sup>	Outdoor & indoor	n.a.	Very good: ΔElab < 3 UVA 340 / 2000h***	M2 & B1
Structured powder coated aluminium frame and backrest	<ul style="list-style-type: none"> <li>A technique of applying dry paint to a part</li> <li>Electrostatically charged and sprayed onto the object</li> <li>Scratch resistant</li> </ul>	10	50 - 100	2,70 10 <sup>2</sup> kg/m <sup>2</sup>	Outdoor & indoor	n.a.	Very good: color can fade to some extent when exposed to UV	NEN-EN13501-1 A2-s1 **
Structured powder coated stainless steel legs & backrest support	<ul style="list-style-type: none"> <li>Easy to clean</li> <li>Stainless steel (for protection against rust), then powder coated</li> <li>Scratch resistant</li> </ul>	2	80	8,00 10 <sup>2</sup> kg/m <sup>2</sup>	Outdoor & indoor	n.a.	Very good: color can fade to some extent when exposed to UV	NEN-EN13501-1 A1*
Sunbrella cushions	<ul style="list-style-type: none"> <li>100% Sunbrella Acrylic</li> <li>Best outdoor fabric available for making cushions</li> <li>Dirt repellent</li> <li>Not waterproof, store inside!</li> <li>Machine washable at max. 30°C. Ironing restores the protective layer</li> </ul>	0,50	n.a.	270 g/m <sup>2</sup>	Outdoor & indoor	Water column of 350mm (EN 20811)	7/8 (ISO 105-B02)	/
High pressure laminate tabletop	<ul style="list-style-type: none"> <li>Manufactured under high pressure</li> <li>Reinforced with wood fibres</li> <li>Flat panel</li> <li>High impact resistance</li> <li>Easy to clean</li> </ul>	13	n.a.	1,40 10 <sup>2</sup> kg/m <sup>2</sup>	Outdoor & indoor	n.a.	>6 (EN438-2:27) en (ASTM G53-91)	/
Stainless steel AISI 316 support for tapa table	<ul style="list-style-type: none"> <li>High rusting resistance</li> <li>Periodical maintenance</li> </ul>	n.a.	n.a.	8,00 10 <sup>2</sup> kg/m <sup>2</sup>	Outdoor & indoor	n.a.	Very good	NEN-EN13501-1 A1*
Cotton pool towel	<ul style="list-style-type: none"> <li>100% cotton</li> <li>Not industrial washable</li> <li>Single pile jacquard</li> <li>Heaviest quality</li> </ul>	n.a.	n.a.	600 g/m <sup>2</sup>	Outdoor & indoor	n.a.	4/8 (ISO-105 B02)	/

### NEN-EN13501-1 A1

Class A1 products will not contribute to fire in any stage, including fully developed fire. For this reason, they are assumed to be capable of satisfying all requirements of all lower classes as well.

### NEN-EN13501-1 A2-sl

Satisfying the same criteria as class B for the SBI-test according to EN 13823. In addition, under conditions of a fully developed fire these products will not significantly contribute to the fire load and fire growth

# Materials & colors

Check price list or [www.extremis.com](http://www.extremis.com) for current materials & colors

## Shade fabric

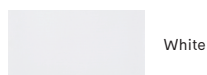

## Tube

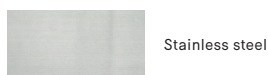

## Handles

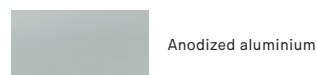

## LED light

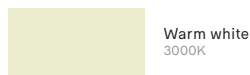
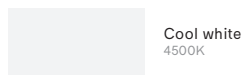

Materials	Key facts	Thickness	Layer thickness	Density	In/outdoor	Water	UV color fastness	Flame retarding
		mm	micron					
High-tech polyester parasol fabric	<ul style="list-style-type: none"> <li>High UV resistance and ultra strong</li> <li>Low weight / high tear strength</li> <li>Long-term appearance</li> </ul>	0,37	n.a.	250 g/m <sup>2</sup>	Outdoor & indoor	The fabric has a water column of 350 mm (EN 2081)	7/8 (ISO 105-B02)	/
LED	<ul style="list-style-type: none"> <li>Color temperature of 4500K (cool white) or 3000K (warm white)</li> <li>9,6 W</li> <li>24 V</li> </ul>	n.a.	n.a.	n.a.	Outdoor & indoor	IP67	/	/
Power supply	<ul style="list-style-type: none"> <li>100 - 240 V</li> <li>50 - 60 Hz</li> <li>DC24V</li> <li>2500mA</li> <li>IP68</li> </ul>	n.a.	n.a.	n.a.	Outdoor & indoor	IP68	/	/
Stainless steel tube AISI 316	<ul style="list-style-type: none"> <li>High rust resistance</li> <li>Periodical maintenance required</li> </ul>	2	n.a.	8,00 10 <sup>3</sup> kg/m <sup>3</sup>	Outdoor & indoor	n.a.	Very good	NEN-EN13501-1 A1*
Anodised aluminium handles	<ul style="list-style-type: none"> <li>A process aimed at thickening the existing aluminium oxide layer</li> <li>Thickest layer of protection</li> </ul>	10	50 - 100	2,70 10 <sup>3</sup> kg/m <sup>3</sup>	Outdoor & indoor	n.a.	Very good	NEN-EN 13501-1 A1*
Cover	<ul style="list-style-type: none"> <li>100% polyester</li> <li>Polyurethane coating</li> <li>Breathable, so not 100% waterproof</li> </ul>	0,50	n.a.	240 g/m <sup>2</sup>	Outdoor & indoor	Water column of 350mm (EN 20811)	6-8/8 (ISO 105-B02)	/

### NEN-EN13501-1 A1

Class A1 products will not contribute to fire in any stage, including fully developed fire. For this reason, they are assumed to be capable of satisfying all requirements of all lower classes as well.

### NEN-EN13501-1 A2-sl

Satisfying the same criteria as class B for the SBI-test according to EN 13823. In addition, under conditions of a fully developed fire these products will not significantly contribute to the fire load and fire growth



## Good to know

- Double function: day bed for 1 and night sofa for 3.



- Sol+Luna had an optional cover.
- The parasol cover is included.
- Sol+Luna has been tested & approved by an independent lab according to the European Standard EN581: outdoor furniture, contract use.
- The connection cable from the light to the driver is 3M.
- 5 different positions:

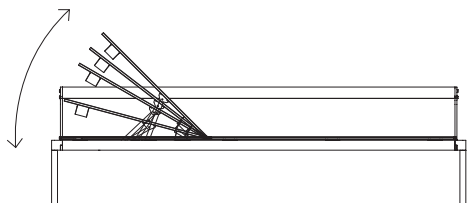

## How to use the shade

The shades are fully adjustable: in height, rotatable in all directions, telescopic arm.

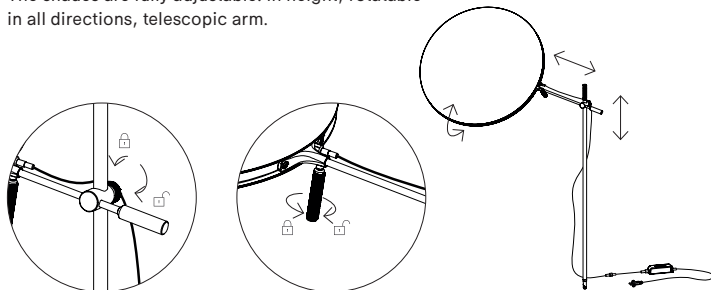

## Maintenance

### POWDER COATED PARTS

- White powder coating obviously requires more maintenance.

### SUNBRELLA

- Shake or brush off loose dirt immediately.
- Spray Extremis Multi Cleaner.
- Use a soft brush and make circular movements.
- Let the suds soak in for a moment.
- Rinse thoroughly to remove all soap residue.
- Simply allow to dry.
- It's also possible to put the blanket and the pillow covers in a washing machine (max 40°C). Follow the cleaning instruction on the label.
- If the cushion has metal brackets, we recommend turning the cover inside out first to avoid damaging the washing machine. In this case, leave the zipper open about 10 cm.

### PARASOL FABRIC

- Shake or brush off loose dirt immediately.
- Spray Extremis Multi Cleaner.
- Use a soft brush and make circular movements.
- Let the suds soak in for a moment.
- Rinse thoroughly to remove all soap residue.
- Simply allow to dry.

### STAINLESS STEEL

- Clean regularly with a dry cloth and some stainless steel cleaner

## F.A.Q.

Q: Can I alter the side of the backrest after assembly?

A: No, but you can choose the side at which the backrest has to be placed while assembling. The place can be changed afterwards, but you'll need tools for that.

Q: Can the cushions stay outside?

A: Yes, but we recommend to store the cushions inside when not used.

Q: Can the parasol stay outdoors?

A: Yes, but we recommend to use a parasol cover.

Q: Do you need to use a parasol cover?

A: Using a cover is strongly recommended for use in most climates around the world. Protect your parasol from polluted rain, bird droppings, dust and heavy winds to avoid marks or stains on the parasol fabric.

## Warnings

### General

- Do not use any sharp tools to open the packaging.
- We strongly advise against using power tools.
- Tripping hazard, mind your step.
- Do not put out cigarettes on the (sofa) sunbed.
- Not graffiti proof.
- Do not leave children unattended whilst playing on the (sofa) sunbed.
- To avoid danger of suffocation, keep plastic bags away from babies and children.
- Colors can differ over years and from batch to batch.

### Product

- Stackable up to 5 pieces.
- Always stack Sol+Luna with 2 people.
- The cushions can stay outside, but we recommend to store the cushions inside when not used.
- It is not necessary to cover the caps on the legs, but we recommend to use them in case the holes are not used for accessories.
- Do not put your fingers in the holes for accessories.
- Do not sit on the tapa table, linking table or backrest.
- Only use Extremis accessories on Sol+Luna.
- Children must not be allowed to adjust the position of the head rest.
- Adjust the position of the head rest with care, to avoid getting your fingers trapped in the hinge system.
- Sitting on the head rest is only possible when it is at

its lowest setting (i.e. perfectly horizontal).

- Do not put anything except Extremis accessories in the holes provided for that purpose: no fingers, chewing gum, cigarette butts etc.
- Do not stand or jump on the Sol+Luna.
- Max. 4 people or 320 kg on the sunbed.

### Powder coating

- White powder coating requires more maintenance.
- Do not use abrasive scouring powders or scourers as they will scratch the surface.
- Color can fade to some extent when exposed to UV.
- Flame retarding - NEN-EN13501-1 A2-sl - Satisfying the same criteria as Class B for the SBI-test according to EN13823. In addition, under conditions of a fully developed fire these products will not significantly contribute to the fire load and fire growth.
- Dark colors can get very hot in sunny weather.

### Batyline

- Shake or brush off loose dirt immediately.
- Never use abrasive substances or solvents.
- Simply allow to dry.
- Very good UV color fastness: Elab < 3 UVA 340 / 2000h.
- Flame retarding: M2 x B1.
- Jeans can leave dye marks on white Batyline, just as they can on other seating fabrics.

### Sunbrella

- Not waterproof, store inside!
- Shake or brush off loose dirt immediately.
- UV color fastness: 7/8 (ISO 105-B02).

### HPL

- UV color fastness: >6 (EN438-2:27) en (ASTM G53-91)

### High-tech polyester

- Shake or brush off loose dirt immediately.
- Do not use any aggressive detergents as they will remove the protective coating of the fabric.
- We strongly advise you not to use a high-pressure hose for cleaning.

### Stainless steel

- Very good UV color fastness.
- Flame retarding: NEN-EN13501-1 A1 - Class A1 products will not contribute to fire in any stage, including fully developed fire. For this reason, they are assumed to be capable of satisfying all requirements of all lower classes as well.
- Watch out, stainless steel isn't entirely rustproof! Be sure to avoid contact with iron objects. If it does show signs of rust, clean with rust remover as quickly as possible.