

# Marina bistro

© design by Metrica

extremis®



## Dimensions

The Marina bistro is available in 2 dimensions

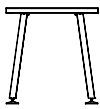
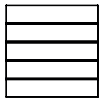

28.25

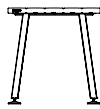

28.25

29.5

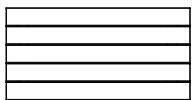

56.75

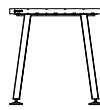

28.25

29.5

## Box dimensions

The Marina bistro comes in 3 boxes

Box 1: 3 profiles



Box 2: 3 profiles



Box 3: Table legs & endpieces



Box dimensions (inch)		L	W	H	Qty	Volume (ft <sup>3</sup> )	Gross weight (lb)	Net weight (lb)	Packaging weight (lb)
Marina bistro 72	Box 1	31.50	5.51	4.72	1	0.35	13.89	12.79	1.10
	Box 2	31.50	5.51	3.15	1	0.35	9.26	8.60	0.66
	Box 3	27.17	4.72	2.95	1	0.35	31.09	29.32	1.76
Total:						<b>1.06</b>	<b>54.23</b>	<b>50.71</b>	<b>3.53</b>
Marina bistro 144	Box 1	59.06	5.51	4.72	2	1.06	28.00	25.57	2.43
	Box 2	59.06	5.51	3.15	2	0.71	18.52	16.98	1.54
	Box 3	27.17	4.72	2.95	1	0.35	31.09	29.32	1.76
Total:						<b>2.12</b>	<b>77.60</b>	<b>71.87</b>	<b>5.73</b>

## Tabletop, legs & endcaps

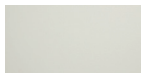

Off white (RAL9002)  
Structured powder coating



Verdigris  
Structured powder coating



Reed green (RAL6013)  
Structured powder coating



Copper brown (RAL8004)  
Structured powder coating



Materials	Key facts	Thickness inch	Layer thickness micron	Density	In/outdoor	Water	UV color fastness	Flame retarding
Coated fiberglass tabletop	<ul style="list-style-type: none"> <li>Made with pultrusion technique: a non-stop process of fibre glass wires pulled through a bath of polyester</li> <li>Strong</li> <li>Lightweight</li> </ul>	0,10	n.a.	0,11 10 <sup>3</sup> lb/ft <sup>3</sup>	Outdoor & indoor	n.a.	Very good: color can fade to some extent when exposed to UV	/
Structured powder coated zinc steel legs	<ul style="list-style-type: none"> <li>Easy to clean</li> <li>Electro galvanized (for extra protection against rust), then powder coated</li> <li>More scratch-resistant than non structured powder coating</li> </ul>	0,11	100	0,47 10 <sup>3</sup> lb/ft <sup>3</sup>	Outdoor & indoor	n.a.	Very good: color can fade to some extent when exposed to UV	NEN-EN13501-1 A1 *
Polyamide feet	<ul style="list-style-type: none"> <li>Injection-moulded nylon</li> <li>Adjustable in height and surface</li> </ul>	n.a.	n.a.	0,07 10 <sup>3</sup> lb/ft <sup>3</sup>	Outdoor & indoor	n.a.	Very good	/

### NEN-EN13501-1 A1

Class A1 products will not contribute to fire in any stage, including fully developed fire. For this reason, they are assumed to be capable of satisfying all requirements of all lower classes as well.

## Good to know

- 27.5 in chair space / person.
- The average transport volume is 6.0 ft<sup>3</sup> / person, which is really low.
- Fiberglass reinforced polyester resin material is made with the so-called pultrusion technique. Pultrusion is a non-stop process of pulling fiberglass wires through a bath of polyester resin and letting them harden in a matrix afterwards to get their final shape.
- Main advantages of this material are its strength and low weight.

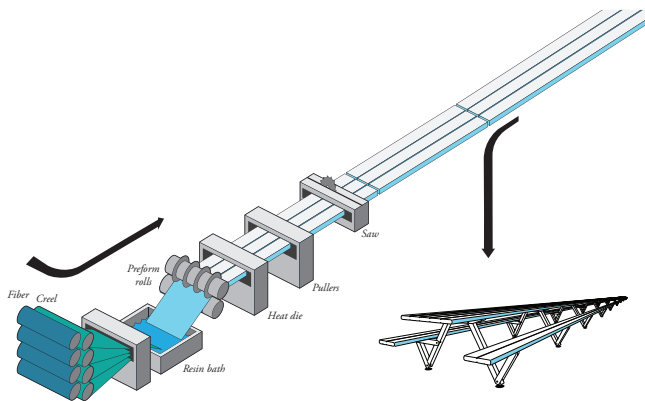

- Marina bistro comes perfectly with Captain's Chairs.



## Maintenance

www.extremis.com/maintenance

### POWDER COATED PARTS

- White powder coating obviously requires more maintenance.

## F.A.Q.

Q: Are the legs corrosion-resistant?

A: The legs are first galvanized, and powder-coated afterwards. This way, we have a double protection layer.

## Warnings

### General

- Do not use any sharp tools to open the packaging.
- We strongly advise against using power tools.
- Tripping hazard, mind your step.
- Do not put out cigarettes on the table.
- Not graffiti proof.
- Do not leave children unattended whilst playing on the table.
- To avoid danger of suffocation, keep plastic bags away from babies and children.
- Colors can differ over years and from batch to batch.

### Product

- Do not drag the table, but carry it with minimum 2 people.
- We strongly advise you against standing on top of the table! A concentrated load can cause small

perceptible cracks in the profiles that might be visually annoying, although they do not affect the strength of the table in any way.

- For table with 3 legs or more, we recommend using trestles to attach the table leg assemblies to the tabletop, instead of keeping it upside down.

### Coated fiberglass

- Do not use abrasive scouring powders or scourers as they will scratch the surface.
- Color can fade to some extent when exposed to UV.
- Dark colors can get very hot in sunny weather.

### Powder coating

- White powder coating requires more maintenance.
- Do not use abrasive scouring powders or scourers as they will scratch the surface.

- Color can fade to some extent when exposed to UV.
- Flame retarding - NEN-EN13501-1 A2-sl - Satisfying the same criteria as Class B for the SBI-test according to EN13823. In addition, under conditions of a fully developed fire these products will not significantly contribute to the fire load and fire growth.
- Dark colors can get very hot in sunny weather.

The content of this document, in particular the mentioned models, is protected by copyrights and/or design rights. The present document and its content is communicated to you for information purposes only. Any partial or total reproduction or any other use without our prior written permission is strictly prohibited. This technical sheet remains subject to possible changes. **All dimensions are in inch**, unless mentioned otherwise. Extremis is not responsible for the errors in the documentation of products. All measurements are approximate and are provided for informational purposes only.

**Tech  
sheet**  
20231215